

Sony VAIO Desktop User Guide

PCV-RS series (PCV-2226 / PCV-2228)

The VAIO logo is rendered in a blue, stylized font. The 'V' is a thick, wavy line that curves down and then up. The 'A' is a solid blue circle. The 'I' is a thick vertical bar with a pointed top. The 'O' is a thick, solid blue circle.

Read this first

Notice

© 2003 Sony Corporation. All rights reserved.

This manual and the software described herein, in whole or in part, may not be reproduced, translated, or reduced to any machine-readable form without prior written approval.

Sony Corporation provides no warranty with regard to this manual, the software, or other information contained herein and hereby expressly disclaims any implied warranties or merchantability or fitness for any particular purpose with regard to this manual, the software or such other information. In no event shall Sony Corporation be liable for any incidental, consequential, or special damages, whether based on tort, contract, or otherwise, arising out of or in connection with this manual, the software, or other information contained herein or the use thereof.

Macrovision: This product incorporates copyright protection technology that is protected by method claims of certain U.S. patents and other intellectual property rights owned by Macrovision Corporation and other rights owners. Use of this copyright protection technology must be authorised by Macrovision Corporation, and is intended for home and other limited viewing uses only unless otherwise authorised by Macrovision Corporation. Reverse engineering or disassembly is prohibited.

Sony Corporation reserves the right to make any modification to this manual or the information contained herein at any time without notice. The software described herein is governed by the terms of a separate user licence agreement.

Please note that the illustrations in this manual, especially of the computer's back panel, may not necessarily apply to your model. Please see the Specifications sheet for the specific configuration of your VAIO.

ENERGY STAR®

As an ENERGY STAR® Partner, Sony has determined that this product meets the ENERGY STAR® guidelines for energy efficiency. The International Energy Star® Office Equipment Program is an international program that promotes energy saving through the use of computers and their office equipment. The program backs the development and dissemination of products with functions that effectively reduce energy consumption. It is an open system in which business proprietors can participate voluntarily. The targeted products are office equipment such as computers, displays, printers, facsimiles and copiers. Their standards and logos are uniform among participating nations.

ENERGY STAR is a U.S. registered mark.



Environmental information



Halogenated flame retardant not used in cabinets.

Cushions formed by corrugated board used in packaging.

Safety information

Owner's record

The serial number and model number are located on the back of your Sony desktop. Record the serial number and the model number and refer to them if you call VAIO-Link. See also the printed **Specifications** document.

Warnings

General

- ❑ Risk of explosion if battery is replaced by an incorrect type. Dispose of used batteries according to the instructions.
- ❑ Opening the unit, for whatever reason, could lead to damages that are not covered by the guarantee.
- ❑ To avoid electrical shock, do not open the cabinet. Refer servicing to qualified personnel only.
- ❑ To prevent fire or shock hazard, do not expose your VAIO desktop to rain or moisture.
- ❑ If reporting a gas leak, do not use the modem or a telephone in the vicinity of the leak.
- ❑ Avoid using the modem during a severe electrical storm.
- ❑ The power socket outlet you are using must be installed near the equipment and must be easily accessible.
- ❑ Do not move your computer while the system is in Standby mode.
- ❑ The magnetic properties of some objects can have serious consequences for your hard disk drive. They can erase the data on the hard disk drive and cause the computer to malfunction. Do not place your computer near or on any objects, which emit magnetic fields, mainly:
 - ❑ TV sets
 - ❑ Speakers
 - ❑ Magnets
 - ❑ Magnetic bracelets.

Audio/video

- ❑ Audio and picture distortion may occur if this equipment is positioned in close proximity to any equipment emitting electromagnetic radiation.

Connectivity

- ❑ Never install modem or telephone wiring during a severe lightning storm.
- ❑ Never install telephone jacks in wet locations unless the jack is specifically designed for wet locations.
- ❑ Be cautious when installing or modifying telephone lines.
- ❑ To disconnect your VAIO desktop completely from the mains voltage, unplug the power cable.
- ❑ Make sure that the socket outlet is easily accessible.

Optical disc drive

The use of optical instruments can cause eye hazard. As the laser beam used in this product is harmful to the eyes, do not attempt any disassembling process. For servicing, refer to qualified personnel only.

There is visible and invisible radiation when the optical disc drive is open: avoid direct exposure to the laser beam. The disc drives are classified as CLASS 1 LASER PRODUCTS and comply with the Laser Product Safety Standard EN 60825-1. Repair and maintenance only by authorised Sony technicians. Improper repairs and use can create safety hazards.

**CLASS 1
LASER PRODUCT
TO EN 60825-1**

Regulatory information

Sony hereby declares that this product is in compliance with the essential requirements and other relevant provisions of European Directive 1999/5/EC (radio equipment and telecommunications terminal equipment Directive).



Declaration of Conformity

The European Union is targeting the free movement of goods for the internal market and to prevent technical barriers to trade. This effort has resulted in several EU Directives asking that manufacturers make their products comply with essential standards. Manufacturers are required to affix the "CE" mark on the products they sell and to draw up a "Declaration of Conformity" (DoC).

Primarily, the Declarations of Conformity are intended for the market surveillance authorities as proof that products satisfy the required standards. Additionally, Sony provides these EU DoC's on the website <http://www.compliance.sony.de> as a service to our customers.

You can search for all Declarations of Conformity available for a specific product by typing in the model name in the search box. A list of matching documents will be displayed and can be downloaded. Please note that the availability of declarations depends on the scope of the EU Directives and the individual product specifications.

This product complies with EN 55022 Class B and EN 55024 for use in the following areas: residential, commercial, and light industrial.

This product has been tested and found compliant with the limits set out in the EMC Directive for using connection cables not longer than 3 metres (9.8 feet).

Before activating the built-in modem, please read the **Modem Regulations** leaflet.



Disposing of the internal memory backup battery

Your Sony VAIO desktop is equipped with an internal back-up memory battery that should not have to be replaced during the lifetime of the product. If you want to replace the battery, please contact VAIO-Link:

<http://www.vaio-link.com>

- Keep away from children.
- Dispose of the battery properly at its end-of-life.
- In some areas the disposal of non-hazardous batteries in household or business waste may be prohibited. Please use the public waste collection system.

Welcome

Congratulations on purchasing a Sony VAIO desktop. Sony has combined leading-edge technology in audio, video, computing and communications to provide you with state-of-the-art personal computing.

Here are the main features you will be able to enjoy:

- ❑ **Exceptional performance** - Your PC includes a fast processor, an internal modem, and a fast Ethernet interface.
- ❑ **Dual drives** – Enjoy the freedom of two disc drives*.
- ❑ **Sony audio and video quality** – The advanced graphics card and high-quality external stereo speakers enable you to take advantage of today's advanced multimedia applications, games, and entertainment software.
- ❑ **Multimedia features** – Enjoy audio and video CDs and DVDs.
- ❑ **Interconnectivity** – Your computer has USB 2.0 and i.LINK™ functionalities.
- ❑ **Windows® XP Home Edition Service Pack 1** - Your system includes the latest consumer operating system from Microsoft.
- ❑ **Excellent customer support** - If you are experiencing any problems with your computer, please check the VAIO-Link website for a possible solution:
<http://www.vaio-link.com>

Before contacting VAIO-Link, please try to solve the problem by reading this guide, especially the section **Troubleshooting (page 53)** or the manuals and help files for the peripherals or software.

* See the printed **Specifications** document for information about the drive.

Documentation pack

Your documentation pack contains printed information and user guides to read on your computer. The user guides are compiled in the **VAIO Info Centre** on the **VAIO Recovery and Documentation Disc**.

Printed documentation

- ❑ A **Getting Started** brochure, where you will find a brief description of the items in your box, and how to setup your computer;
- ❑ A **Specifications** sheet, containing a table of specifications, a list of bundled software and, on the reverse side, a guide to setting up your VAIO;
- ❑ A **Guide to Troubleshooting / Using the VAIO Recovery and Documentation Disc**, where you will find troubleshooting, an explanation of the purpose and use of the VAIO Recovery and Documentation Disc and VAIO-Link information;
- ❑ A **Dual Language Operating System** leaflet*;
- ❑ Your **Sony Guarantee** conditions;
- ❑ A **Safety Regulations** leaflet;
- ❑ A **Modem Regulations** leaflet.

* Depending on your country. Dual Language Operating Systems are available in **Belgium** (Dutch and French), **the Netherlands** (Dutch and English) and **Switzerland** (German and French).

Documentation on disc

The online part of your documentation includes the following:

- 1 The **Hardware Guide** (this guide):
 - ❑ **Using your VAIO Desktop** shows you how to use the standard components of your system.
 - ❑ **Connecting peripheral devices** explains how you can add functionality by connecting various peripherals.
 - ❑ **Getting help** explains the support options available to you, and offers basic troubleshooting tips.
 - ❑ **Precautions** provides facts and advice about using your VAIO.
 - ❑ **Glossary** refers to terms used in this manual.
- 2 Refer to your **Software Guide** for information on the software and how to use Sony applications.
 - ❑ **About the Software** is a short description of the features of the software available with VAIO systems.
 - ❑ **Using Video software** explains how to use Sony video software: DVgate and Network Smart Capture.
 - ❑ **Managing audio files with SonicStage** explains how to convert your existing MP3, WMA and WAV format audio files into ATRAC3 format.
 - ❑ **Using PictureGear Studio** explains how to get the most enjoyment out of your photographs taken with a digital camera.
 - ❑ **Using Click to DVD** explains how to capture video images from a digital external device (camera, VCR, etc.) and write them to a DVD (for models with a DVD writer).
 - ❑ **Using VAIO Media** explains how to enjoy music, video and photos through your home networking environment.
 - ❑ **Customising your computer** explains how to configure your modem and set a wallpaper.

- **Installing and updating applications** explains how to install, run or uninstall a software application.
 - **Managing drivers** explains how to install, update or uninstall a driver.
- 3 In the **VAIO-Link Customer Service Guide** you will find all the VAIO-Link information you need, including specific contact numbers for each country.

Further sources

- 1 Consult the **Online Help** files of the software you are using for detailed information on features and troubleshooting.
- 2 Refer to the Microsoft **Quick Start** manual for more information on Windows®.
- 3 Go to <http://www.club-vaio.com> to find online tutorials about your favourite VAIO software.

Your Sony VAIO desktop and its accessories

The following hardware items are in the box:

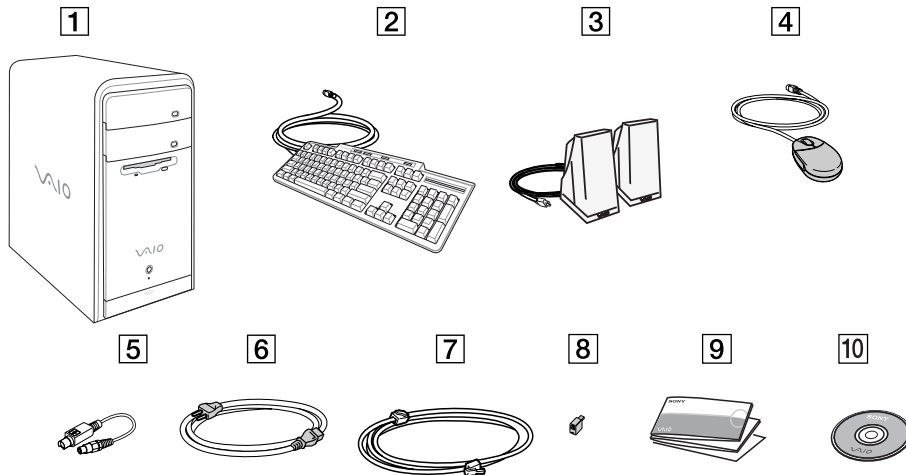

1	Main unit	6	Power cable
2	VAIO keyboard	7	Phone cable (only for UK)
3	Stereo speakers	8	Phone plug (only for UK)
4	VAIO wheel mouse	9	Documentation pack
5	TV-Out cable	10	VAIO Recovery and Documentation Disc*



*See the printed **Guide to Troubleshooting and Using the VAIO Recovery and Documentation Disc** for details.

Ergonomic considerations

Whenever possible, try and take into account the following ergonomic considerations when using your new computer, whether at home or in the office:

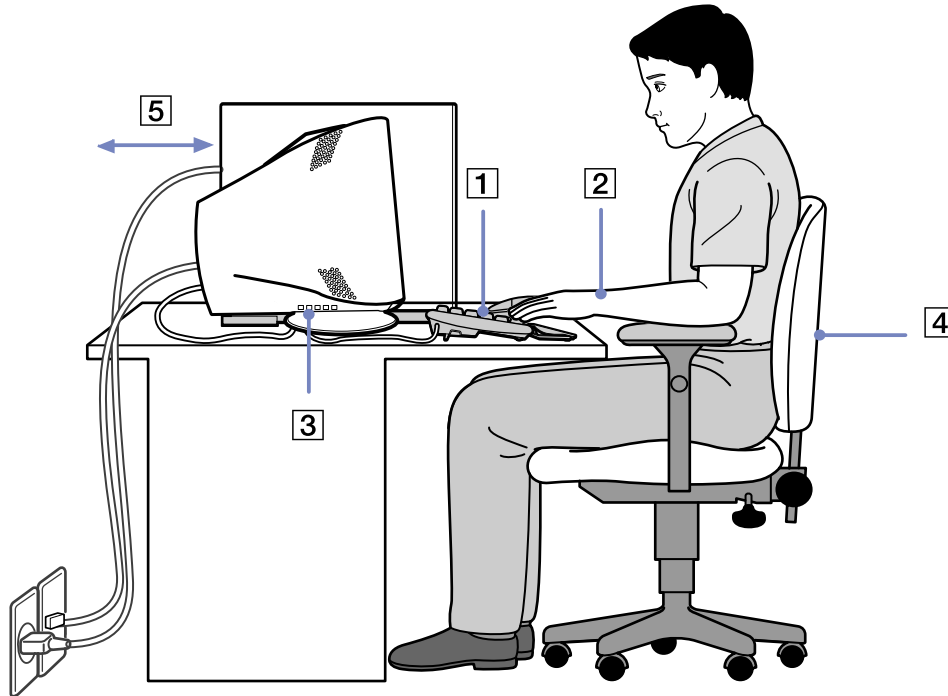

- ❑ **Position of the keyboard and mouse** – Place the keyboard directly in front of you (1). Keep your forearms horizontal, with your wrists in a neutral, comfortable position (2) while using the keyboard or mouse – not at an angle. Let your upper arms hang naturally at your sides. Place the mouse at the same level as the keyboard and use your whole arm to move it.
- ❑ **Position and viewing angle of the monitor** – Set the display at a comfortable viewing distance (3). Make sure the display screen is at eye level or slightly lower. Use the display's tilting feature, if available, to find the best position. You can reduce eye-strain and muscle-fatigue by adjusting the tilt of the display to the proper position. Remember to adjust the brightness setting of the display. If you are using a CRT monitor, make sure that the refresh rate is at an optimal level, that is, at least 75Hz.
- ❑ **Furniture and posture** – Sit in a chair with good back support (4). Adjust the level of the chair so your feet are flat on the floor. A footrest may make you more comfortable. Sit in a relaxed, upright posture and avoid slouching forward or leaning too far backwards.
- ❑ **Lighting** – Choose a location where windows and lights do not create glare or reflection on the display. Use indirect lighting to avoid bright spots reflecting on the display. You can also purchase accessories for your display that help reduce glare. Proper lighting adds to your comfort and work effectiveness.
- ❑ **Ventilation** – Make sure you leave at least 25 cm of space behind and on the left of the main unit (5).
- ❑ **And finally** – Remember to have breaks during sessions with your computer. Excessive use of the computer may strain muscles or tendons.

Using your VAIO desktop

This section describes how to start using your computer and how to use your computer's internal and external devices.

- ❑ [Locating connectors \(page 15\)](#)
- ❑ [Starting your computer \(page 16\)](#)
- ❑ [Shutting down your computer \(page 17\)](#)
- ❑ [Using the keyboard \(page 18\)](#)
- ❑ [Setting up the monitor \(page 23\)](#)
- ❑ [Using the mouse \(page 24\)](#)
- ❑ [Using the disc drives \(page 25\)](#)
- ❑ [Using the floppy disk drive \(page 28\)](#)
- ❑ [Using the modem \(page 29\)](#)
- ❑ [Expansion capabilities \(page 30\)](#)
- ❑ [Using power saving modes \(page 31\)](#)

Locating connectors

Please see the printed **Specifications** sheet to identify connectors on your model.

Starting your computer

Once you have all the components set up as described in the **Getting Started** guide, you can begin to use your computer.

To start up your computer, proceed as follows:

- 1 Press the power button on the system unit until the blue VAIO light turns on (1).
- 2 Press the power button on your monitor to turn the display on (2).
- 3 Push the power button on the speakers, located on the side of the right speaker, to turn the sound on (3).

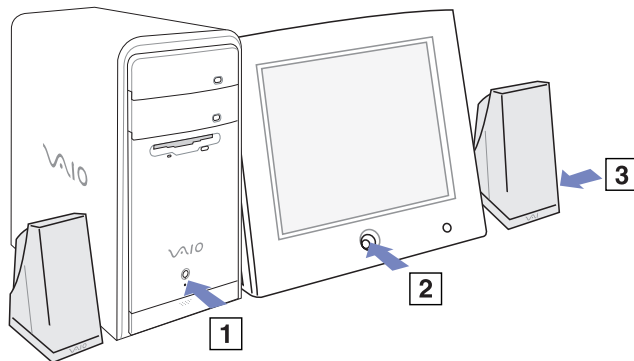

 If you press the computer's power button for more than six seconds, the system will switch itself off.

Shutting down your computer

It is important that you shut down your computer properly so you do not lose unsaved data.

To shut down your computer, proceed as follows:

- 1 Click the **Start** button.
- 2 Click **Turn Off Computer**.
The **Turn off computer** screen appears.
- 3 Click **Turn Off**.
Wait for your computer to turn off automatically.
The power indicator turns off.
- 4 Turn off any peripherals connected to your computer.

 Respond to any prompts warning you to save documents or to consider other users.

If you are unable to shut down your computer;

- Close all software in use.

- Disconnect any USB devices.

- Press <Ctrl>+<Alt>+<Delete> at the same time. If you have not changed the default setting, you will enter the **Task Manager**. Select **Turn Off** from the **Shut Down** menu to turn the computer off.

Alternatively, press <Alt>+<F4> and select **Turn Off** from the screen that appears.



If this does not work, you can press the power button for more than six seconds. This will shut down the computer. This operation may result in loss of data.

If you want to shut down the computer for a short period only, you can save power by using the **Standby** mode. Go to **Start, Turn Off Computer**, and select **Stand By** (see **Using power saving modes (page 31)** for details).

Using the keyboard

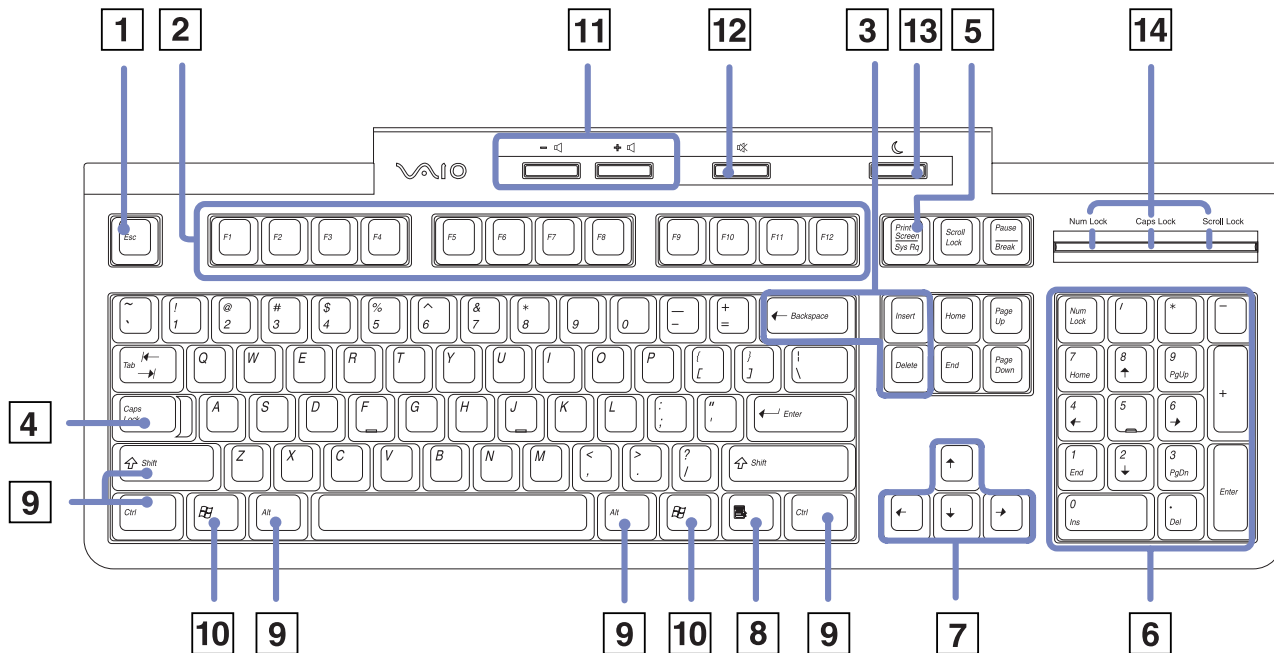
This section describes the features of the VAIO keyboard.













<i>Keys</i>	<i>Descriptions</i>
Escape key (1)	The <Esc> (Escape) key is used to cancel commands.
Function keys (2)	The twelve function keys along the top of the keyboard are used to perform designated tasks. For example, in many applications, <F1> is the Help key. The task associated with each function key may vary from one application to another.
Correction keys (3)	The <Insert> , <Back Space> and <Delete> keys enable you to make corrections when typing.
Lock keys (4)	Press <Caps Lock> once to activate the uppercase characters. Use the <Num Lock> key to activate the numerical keypad.
Print Screen key (5)	The <Prt Sc> key takes an electronic snapshot of the screen and moves it to the Windows® Clipboard. You can then paste the screenshot into a document and print it.
Numeric keypad area (6)	This contains the keys found on a typical calculator. Use the numeric keypad area to type numbers or to perform mathematical calculations such as addition and subtraction. Note that you must press the <Num Lock> key to activate the keypad.
Navigation keys (7)	These keys enable you to move the cursor on the screen.
Application key  (8)	The <Application> key displays a shortcut menu; pressing this key is equivalent to clicking the right mouse button.
Operator keys (9)	Several keys are used in combination with at least one other key: <Ctrl> , <Alt> and <Shift> . When held down at the same time as another key, the <Ctrl> (Control) and <Alt> (Alternate) keys offer another way to execute commands. For example, in many applications, instead of choosing the Save command from a menu, you can hold down <Ctrl> and press <S> (referred to as <Ctrl>+<S>). The <Shift> key is used to type capital letters or special symbols such as @ and \$.
Windows® key  (10)	The key with the Windows® logo displays the Windows® Start menu; it is equivalent to clicking the Start button on the taskbar.
Volume buttons (11)	Press the - button to decrease volume, and the + button to increase.
Mute button (12)	Press once to mute the system sound, press again to restore the sound.

*Keys**Descriptions*

Standby button (13)	Press this button either to start up your computer, or to enter Standby mode, or to resume from a power saving mode.
Indicator LEDs (14)	A green light indicates whether the Num Lock , Caps Lock , and Scroll Lock functions are active.

Combinations and functions with the Windows key

<i>Combinations</i>	<i>Function</i>
 + <F1>	Displays Windows® Help and Support Center .
 + <Tab>	Switches the selected button on the taskbar.
 + <D>	Displays the desktop.
 + <E>	Displays My Computer .
 + <F>	Displays the Search Results window to find a file or folder. This is equivalent to selecting Search from the Start menu.
 + <Ctrl> + <F>	Displays the Search Results - Computers window where you can locate other computers.
 + <L>	Locks your computer.
 + <M>	Minimises all displayed windows.
<Shift> +  + <M>	Returns all minimised windows to their previous size.
 + <R>	Displays the Run window. This is equivalent to selecting Run from the Start menu.
 + <U>	Launches the Windows® Utility Manager .

Indicators

<i>Light</i>	<i>On</i>	<i>Off</i>
Num Lock	Turns on when the number keys in the numeric keypad are active.	Turns off when the alphanumeric character keys in the keypad area are active.
Caps Lock	Turns on when the letters appear in uppercase as you type. The <Shift> key lowers the case of typed letters when Caps Lock is on.	Turns off when the letters appear in lowercase as you type (unless you hold down the <Shift> key).
Scroll Lock	Turns on when the screen scrolls differently (not all applications support this function).	Turns off when the information moves across the display normally.

Setting up the monitor

If your VAIO desktop is delivered with a monitor, it may be delivered with a digital 15" or 17" LCD (XGA TFT) monitor or with a common analogue CRT monitor, depending on your model and vendor.

For more information on how to use your delivered monitor, refer to the user manual that came with it. You can also refer to the section **Connecting an external display (page 37)**.

Connecting the monitor

To connect your monitor, proceed as follows:

- 1 Plug one end of the monitor cable into the connector on the back panel of your computer.
 - 2 Plug the other end of the monitor cable into the back of your monitor.
- The monitor is now ready for use.

 There are two ports: one for DVI screens and one for common VGA and CRT screens. Make sure you use the appropriate connector.

This illustration may not correspond to the configuration of your model. Please check the section **Back Panel** of your printed **Specifications** sheet to see where the ports are exactly.

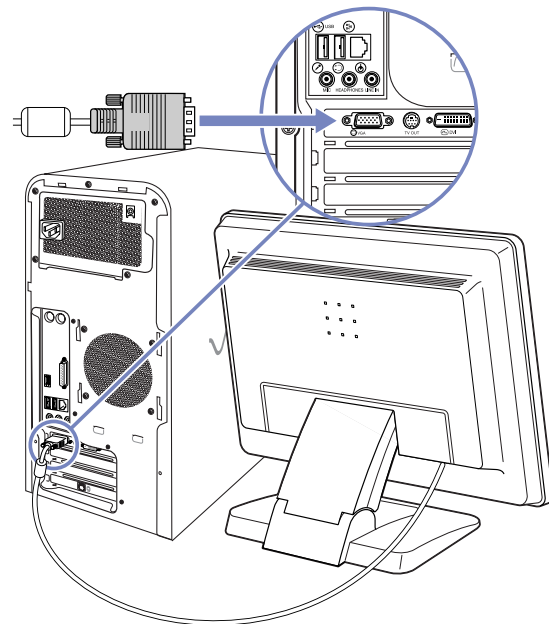

Using the mouse

The VAIO wheel mouse allows you to control the cursor in a number of ways. You can point to, select, drag, and scroll objects on the screen using the buttons and the wheel.

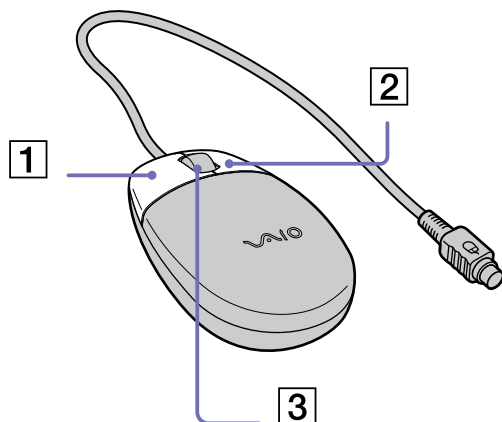

<i>Function</i>	<i>Action</i>
Point	Move the entire mouse across a flat surface to place the pointer on an item or object.
Click	Press the left button (1) once.
Double-click	Press the left button twice.
Right-click	Press the right button (2) once. In many applications, this action displays a context-sensitive shortcut menu.
Drag and drop	Hold the left button down while sliding the mouse. Then release the button to drop the object.
Scroll	Turn the central wheel (3) to scroll up or down a page. Or press the wheel once to lock the scroll action and control the movement by moving the entire mouse (the scroll function is available only with applications that support a scroll feature).

You can adjust the mouse pointer speed and other functions under **Mouse Properties**. To display **Mouse Properties**, go to the **Control Panel**, select **Printers and Other Hardware**, then select **Mouse**.



You can set the mouse up for left-hand use. See the **Troubleshooting (page 53)** section for details.

Using the disc drives

Your computer is equipped with two separate drives. See the **Specifications** sheet for details on your model.

- ❑ The DVD±RW drive reads data from and writes data onto DVD and CD.
- ❑ The DVD-RW drive reads data from and writes data onto DVD and CD.
- ❑ The CD-RW drive reads data from and writes data onto CD.
- ❑ The DVD-ROM drive reads data from DVDs and CDs.
- ❑ The CD-ROM drive reads data from CDs.

To insert a disc, proceed as follows:

- 1 Turn on the computer.
- 2 Press the appropriate eject button to open the drive.
The cover flap opens and the tray slides out.
- 3 Place a disc in the tray with the label side facing upwards. Make sure the disc is secure in the centre of the tray.
- 4 Close the tray by pushing it gently.

 When the computer is in **Standby** or **Hibernate** mode, you cannot insert or remove a disc.

Make sure you seat the disc firmly in the tray. Otherwise, you could damage your disc drive and you may not be able to open the tray.

When you have finished using a disc, wait until the LED indicator turns off before pressing the eject button to remove the disc.

If the tray does not come out when you press the eject button, go to **Windows Explorer** or **My Computer**. Select the drive, click the right button of your mouse and select **Eject**.

CD/DVD writable drives: What (re)writable CD formats can I use?

Recordable and rewritable CD formats include CD-R, CD-RW (high-speed supported). CD-R (recordable) allows one-time recording on a disc whereas CD-RWs can be rewritten as many as 1,000 times.

Writing CDs and DVDs

To achieve optimum performance when writing data on to disc (also called 'burning'), follow these recommendations:

- ❑ Only use circular discs. Do not use discs with any other shape (star, heart, card, etc.), as this may damage the disc drive.
- ❑ Do not strike or shake the computer while writing data to a disc.
- ❑ For optimum writing speed, deactivate the screensaver before writing data to a disc.
- ❑ Memory-resident disc utilities may cause unstable operation or data loss. Deactivate these utilities before writing data to a disc.
- ❑ When using a software application to burn discs, make sure you exit and close all other applications.
- ❑ Never touch the surface of the disc. Fingerprints and dust on the surface of a disc may cause writing errors.
- ❑ Never put stickers on discs. This will affect the use of the disc irreparably.

Playing DVDs

To achieve optimum performance when playing DVD-ROMs, you should follow these recommendations:

- ❑ Close all open applications before playing a DVD-ROM movie.
- ❑ You can play DVDs with the software PowerDVD for VAIO.
- ❑ Do not switch power saving modes while playing a DVD-ROM.
- ❑ Do not use resident disc utilities or other resident utilities to speed up the access of discs, because they may cause the system to become unstable.

- ❑ Make sure that the screensaver is deactivated.
- ❑ Region codes indicators are labelled on the DVDs to indicate in which region and on what type of player you can play the disc. Unless a **2** or **ALL** is labelled on your DVD or on the packaging, you cannot play the disc on this player.
- ❑ Do not try to change the region code settings of the DVD drive. Any difficulties caused by changing the region code settings of the DVD drive are out of warranty.

Using two screens while watching a DVD film

By connecting a TV to your computer, you can watch a DVD film while still working on your desktop as normal.

To use the two screens and change the DVD playback settings, proceed as follows:

- 1 Connect your TV to the computer as described in **Connecting a TV (page 40)**.
- 2 Go to **Control Panel**.
- 3 Click **Appearance and Themes** and then **Display**.
The **Display Properties** dialog box appears.
- 4 Click the **Settings** tab.
- 5 Click **Advanced**.
The **...NVIDIA GeForce FX...** dialog box appears.
- 6 Click **nView Display Mode** on the left.
- 7 Select the **Clone** check box.
- 8 Click **Overlay Controls** on the left.
- 9 Make your required settings here.
- 10 Click **OK** when you have finished.

Using the floppy disk drive

Your VAIO desktop is equipped with a floppy disk drive.

Inserting a floppy disk

To insert a floppy disk, proceed as follows:

- 1 Hold the floppy disk with the label side facing up.
- 2 Gently push the disk into the floppy disk drive until it clicks into place.

Removing a floppy disk

To remove a floppy disk, proceed as follows:

- 1 Wait until the LED indicator turns off.
- 2 Press the eject button and pull the disk out gently.

 Do not press the eject button when the LED indicator is turned on. Otherwise, data may be lost.

Using the modem

Your VAIO desktop is equipped with an internal modem. You need to connect a phone line to take advantage of online services and the Internet, to register your computer and software online, and to contact VAIO-Link.

To connect a phone line, proceed as follows:

- 1 Plug one end of your phone cable into the LINE port on the back of the computer.
- 2 Plug the other end into the wall jack.



Your computer cannot be connected to a coin-operated telephone, and may not work with multiple phone lines or a private branch exchange (PBX). If you connect the modem to a parallel connected phone line, the modem or the other connected device may not function properly. Some of these connections may result in excess electrical current and could cause a malfunction in the internal modem.

Only DTMF (Dual Tone Multi Frequency) signalling (tone dialling) is supported.

This illustration may not correspond to the configuration of your model. Please check the section **Back Panel** of your printed **Specifications** sheet to see where the ports are exactly.

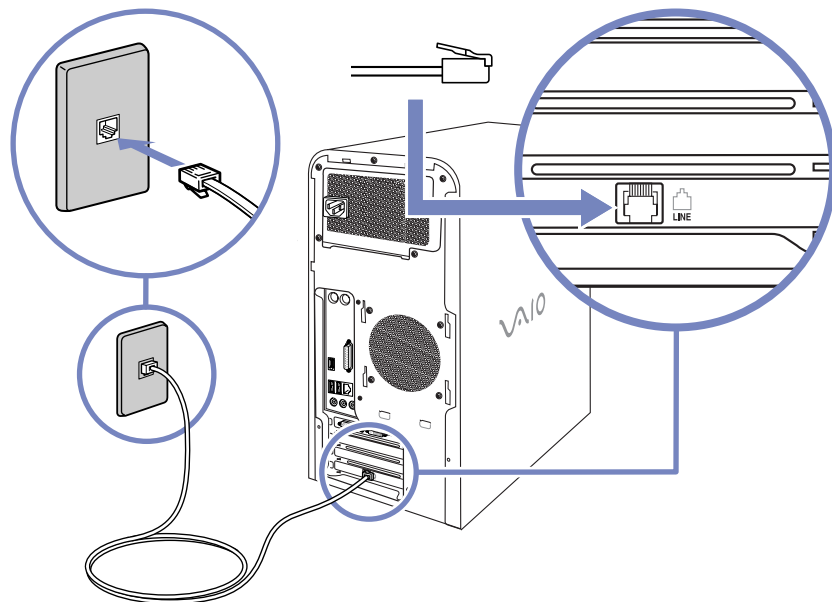

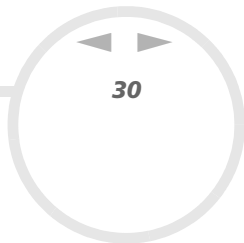

Expansion capabilities

There are four expansion slots at the rear of your VAIO computer, as follows:

- 1 (bottom slot) CNR slot containing the modem card.
- 2 Empty PCI slot.
- 3 Empty PCI slot.
- 4 (top slot) AGP slot containing the graphics card.

The empty PCI slots allow you the choice of adding to the expansion capabilities of your computer. See **Upgrading your VAIO computer (page 73)** for more details.

You are strongly advised not to add hardware yourself. Please contact your local Sony dealer for advice on changing the internal hardware components.

Using power saving modes

The colour of the VAIO and power indicator lights on the main unit tells you which mode the computer is in.

<i>VAIO light</i>	<i>Power indicator</i>	<i>Mode</i>
Blue	No light	Computer is in Normal mode
No light	Umber	Computer is in Standby mode
No light	No light	Computer is turned off or in Hibernate mode

Using Standby mode

If you plan to stop using your computer for a short period of time (not overnight), you can put it into **Standby** mode instead of turning it off completely. Putting the computer into **Standby** mode saves energy and allows a quick return to normal computer use.

To set the timer for your computer to automatically enter **Standby** mode after a certain amount of time, go to **Control Panel**, click **Performance and Maintenance** and open **Power Options**.

To activate **Standby** mode manually, use one of these two methods:

Use the **Standby** button:

- 1 Save your work, close all applications and close your Internet connection, if applicable.
- 2 Press the **Standby**  button at the top of the keyboard.
The computer goes into **Standby** mode, indicated by the umber light under the power button.

Use the Windows® taskbar:

- 1 Save your work, close all applications and close your Internet connection, if applicable.
- 2 From the **Start** menu on the Windows® taskbar, select **Turn Off Computer**.
Alternatively, press <Alt>+<F4> to get to the same dialog box.
- 3 Select **Stand By**.
The computer goes into **Standby** mode, indicated by the amber light under the power button.

To return to Normal mode, choose from the following:

- ❑ Press any key on the keyboard.
- ❑ Press the **Standby** button again.
- ❑ Quickly press the power button on your computer.

 You can leave Windows® running when using **Standby**.

If you press the power button for more than six seconds, the computer will switch off completely.

When the computer is in **Standby** mode, you cannot insert a disc.

The computer comes out of **Standby** mode quicker than out of **Hibernate** mode.

Standby uses more power than **Hibernate**.

Using Hibernate mode

If you are interrupted and need to leave your computer suddenly, you can put it into **Hibernate** mode. This power saving mode saves you the time of shutting down in the normal way.

When you put your computer into **Hibernate** mode:

- Everything in the memory is saved to the hard disk.
- The monitor and hard disk are turned off.
- The computer is turned off.
- The power indicator light turns off.

To set the timer for your computer to automatically enter **Hibernate** mode after a certain amount of time, go to **Control Panel** click **Performance and Maintenance** and open **Power Options**.

To activate **Hibernate** mode manually, use one of these two methods:

Use the Windows® taskbar:

- 1 Save your work.
- 2 From the **Start** menu on the Windows® taskbar, select **Turn Off Computer**.
Alternatively, press <Alt>+<F4> until the **Turn Off Computer** screen is displayed.
- 3 In the **Turn Off Computer** screen, hold down the <Shift> key to reveal the **Hibernate** button.
- 4 Click **Hibernate**.
The computer goes into **Hibernate** mode, the computer turns off.

Use the power button:

- Quickly press the power button on the front of the main unit.
The computer goes into **Hibernate** mode, the computer turns off.

To return to **Normal** mode, quickly press the power button on your computer.
Operation returns to the same state as before.



You can leave Windows® running when using **Hibernate**.

If you press the power button for more than six seconds, the computer will switch off completely.

When the computer is in **Hibernate** mode, you cannot insert a disc.

Hibernate uses less power than **Standby**.

Hibernate requires more time than **Standby**.

Connecting peripheral devices

You can add functionality to your computer by connecting any of the following peripherals, and more. Before you connect a peripheral, turn off both the computer and the peripheral. Connect the power cord only after connecting all cables. Turn on the computer only after turning on all peripherals.

- ❑ Notes on connecting Universal Serial Bus (USB) devices ([page 36](#))
- ❑ Connecting an external display ([page 37](#))
 - ❑ Connecting a projector ([page 39](#))
 - ❑ Connecting a TV ([page 40](#))
- ❑ Connecting an external microphone ([page 42](#))
- ❑ Connecting a printer ([page 43](#))
 - ❑ Connecting a USB printer ([page 44](#))
- ❑ Connecting an i.LINK™ device ([page 45](#))
 - ❑ Connecting a digital video camera recorder ([page 46](#))
 - ❑ Connecting two VAIO computers ([page 47](#))
- ❑ Connecting to a network ([page 48](#))



Hot plug and play devices (such as USB devices) should be plugged in when the computer is switched on.

Notes on connecting Universal Serial Bus (USB) devices

You can connect a USB device, for example, a scanner or a printer, to your VAIO desktop. Your computer features the latest USB technology, having been upgraded to USB Specification version 2.0. USB Specification version 2.0 increases device data throughput up to 480 Mbps, 40 times faster than USB 1.1 devices.

With the increased speed, you have the benefit of an additional range of high performance peripherals. Even with multiple high-speed peripherals connected to a USB 2 bus, you do not have to worry about hitting the bandwidth bottleneck. The new specification also inherits the current USB's Plug and Play and hot-swapping capability as well as providing backward compatibility for USB 1.1 hardware.

There are USB ports on the front and back of your VAIO desktop. To connect a USB device, simply plug in the USB cable of the device into one of the ports on your computer.

 USB devices are hot plug and play devices. You do not need to shut down your computer prior to connecting these devices unless the manual supplied with the device states otherwise.

For some USB devices you need to install the software before you connect the device. Not following this procedure might cause the device not to work properly. For more information, check the manual provided with the USB device.

You do not need to shut down the computer before connecting or disconnecting a USB peripheral.

Connecting an external display

You can connect multiple displays to your desktop, each using a different port on the back of your computer:

- an LCD screen using the DVI connector,
- a CRT or LCD screen using the VGA connector,
- a TV using the TV-Out connector.

See also **Setting up the monitor (page 23)** and **Using two screens while watching a DVD film (page 27)**.

Please make note of the following viewing possibilities:

- If you have a VGA and a DVI display connected at the same time, you can switch from one display to the other (the default is VGA), but you cannot display the image on both at the same time.
- If you have a VGA and a TV connected, the image is shown on both screens by default.
- If you have a DVI and a TV connected, the image is shown on both screens by default.
- If you have a VGA, a DVI and a TV connected, the image will be shown either on both the VGA and the TV, or both the DVI and the TV.

To change your display from VGA to DVI or vice versa, proceed as follows:

- 1 Connect the display(s), as described in **Setting up the monitor (page 23)** or in the instructions delivered with the display, if applicable.
- 2 Go to **Control Panel**.
- 3 Click **Appearance and Themes** then **Display**.
The **Display Properties** dialog box appears.
- 4 Click the **Settings** tab.
- 5 Click **Advanced**.
The **...NVIDIA GeForce FX...** dialog box appears.

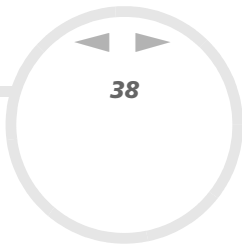

- 6 Click **nView Display Mode** on the left.
- 7 Select the **Device Settings** button.
- 8 Click **Select Output Device...** and select the desired display.
- 9 Click **OK**.

If you reboot after changing the settings as above, the default setting returns and the image is shown on the VGA screen again. If you want the image to be shown on both the DVI and the TV after rebooting, please disconnect the VGA.

Similarly, if you have all three displays connected and want the computer to select DVI and TV when you start your computer, simply make your settings again.

Connecting a projector

You can connect a projector (such as the Sony LCD projector) directly to your computer.

To connect a projector to your VAIO desktop, proceed as follows:

- 1 Plug one end of the VGA cable (not supplied) into the VGA connector on the back of your computer, and the other end into the projector you want to use (1).
- 2 Plug the audio cable (not supplied) into the headphones connector identified by the  symbol (2).
- 3 Connect the power cord of the projector into an AC outlet (3).

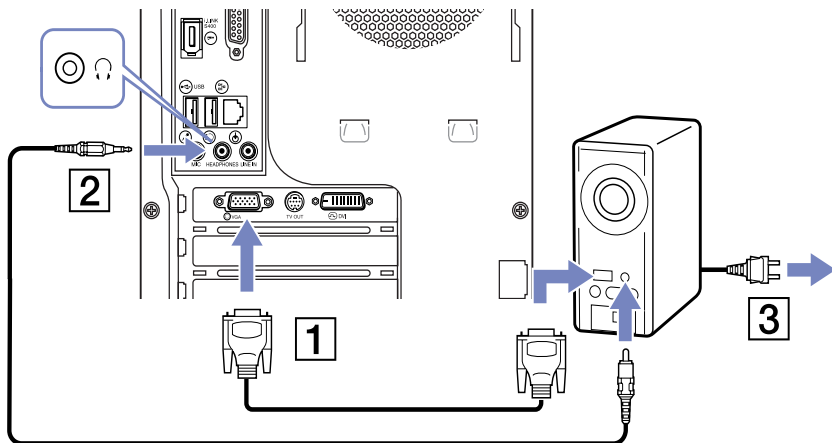

 This illustration may not correspond to the configuration of your model. Please check the section **Back Panel** of your printed **Specifications** sheet to see where the ports are exactly.

Connecting a TV

You can connect a TV directly to your computer. See also **Using two screens while watching a DVD film (page 27)**.

In order to be able to use a TV screen, you also have to enable the TV-Out function.

Your VAIO desktop is delivered with a TV-Out cable (or 'converter cable'), which is for use with TV sets without an S-Video port.

Connecting a TV that has no S-Video port

To connect a TV to your VAIO desktop with the supplied TV-Out cable, proceed as follows:

- 1 Plug one end of the TV-Out cable into the TV-Out port on the back of your computer.
- 2 Take your composite cable (not supplied) and connect one end to the inserted TV-Out cable.
- 3 Connect the other end to the yellow-coloured port (Video-In) on your TV set.
The video output is now in place.
- 4 Connect the single end of your audio cable (not supplied) to the headphones port, either on the back of your computer or on the connected speaker.
- 5 Connect the double end of the audio cable to the red and white ports respectively on your TV set.
The audio output is now in place and your TV is ready for use with your computer.

Connecting a TV that has a S-Video port

To connect a TV to your VAIO desktop with an S-Video cable (not supplied), proceed as follows:

- 1 Plug one end of the S-Video cable into the TV Out port on the back of your computer.
- 2 Plug the other end of the S-Video cable into your TV's S-Video port.

To enable TV Out, proceed as follows:

- 1 Go to the **Control Panel**.
- 2 Click on the **Appearance and Themes** icon and then **Display**.
The **Display Properties** dialog box appears.
- 3 Click the **Settings** tab.
- 4 Click **Advanced**.
The **...NVIDIA GeForce FX...** dialog box appears.
- 5 Click **nView Display Mode** on the left.
- 6 Select the **Device Settings** button.
- 7 Click **Select Output Device...** and select the TV display.
- 8 Click **Apply** and **OK** when you have finished.

Connecting an external microphone

Your VAIO desktop does not contain an internal microphone. If you need to use a sound input device, for example to chat on the Internet, you need to plug in an external microphone.

To connect an external microphone, plug the microphone cable (1) into the microphone port (2) identified by the symbol .

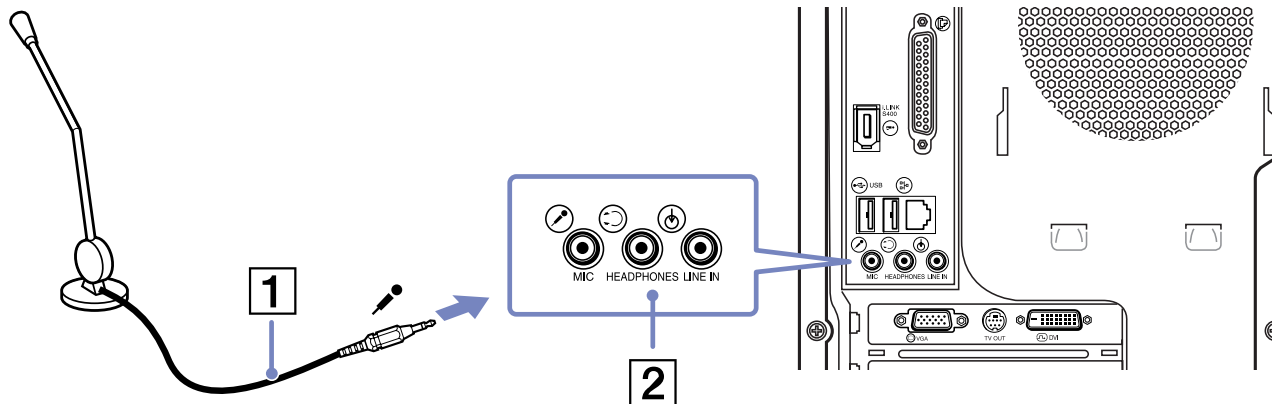

 Make sure your microphone is designed for computer use.

This illustration may not correspond to the configuration of your model. Please check the section **Back Panel** of your printed **Specifications** sheet to see where the ports are exactly.

Connecting a printer

To connect a printer, proceed as follows:

- 1 Plug the printer cable into the printer connector on your computer.
- 2 Plug the printer power cord into an AC outlet.

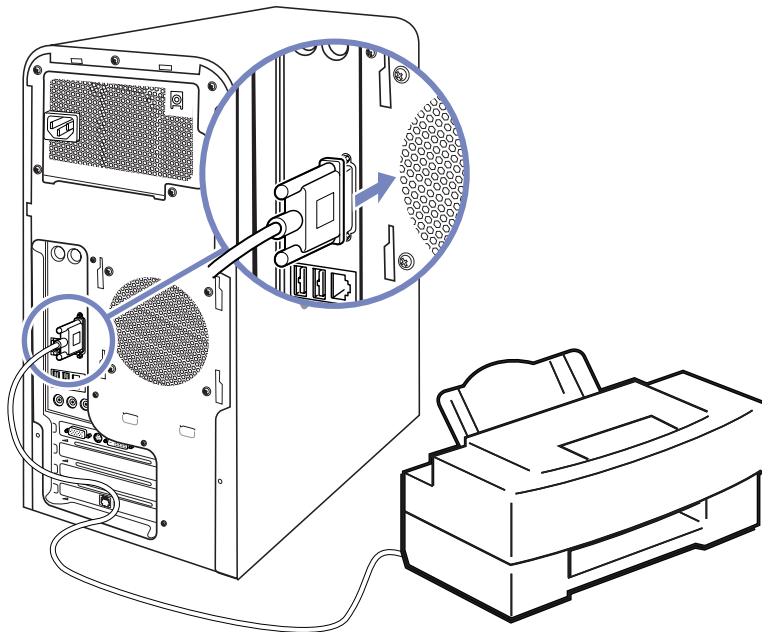

This illustration may not correspond to the configuration of your model. Please check the section **Back Panel** of your printed **Specifications** sheet to see where the ports are exactly.

Connecting a USB printer

To connect a USB printer, simply plug the printer's USB cable into one of the USB ports on your VAIO desktop. There are USB ports at the front and at the back of your computer.

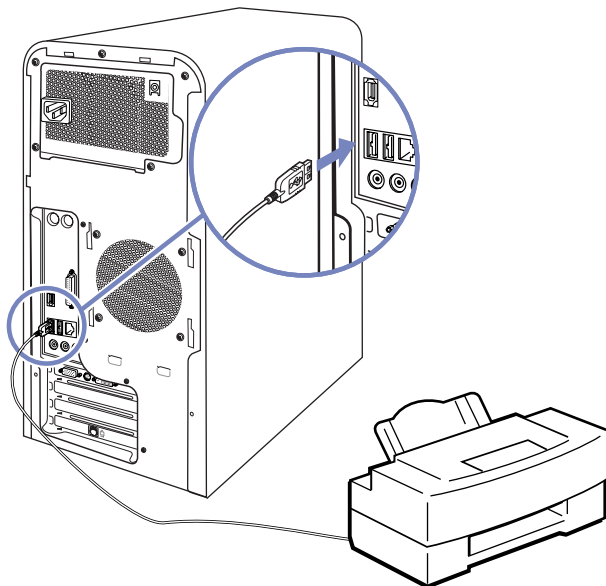

 Do not turn on the computer or the printer until all the connections are made.

These procedures do not apply to all printers. If you do not have a printer compatible to these procedures, please refer to the manufacturer's instructions on connecting and installing it.

This illustration may not correspond to the configuration of your model. Please check the section **Back Panel** of your printed **Specifications** sheet to see where the ports are exactly.

Connecting an i.LINK™ device

Your VAIO computer includes a 4-pin i.LINK™ port on the front of the system and a 6-pin i.LINK™ port on the back of the system. Use these ports to connect an i.LINK™ device such as a digital video camera recorder or to link up two VAIO computers so you can copy, delete or edit files.

- ❑ The 6-pin i.LINK™ port can supply power from the computer to the connected device.
- ❑ The 4-pin i.LINK™ port cannot supply power to a connected device.

The i.LINK™ ports supports transfer rates up to 400 Mbps; however, the actual transfer rate depends on the transfer rate of the external device.

The i.LINK™ features available may vary depending on the software applications you use. Refer to the documentation that came with your software for more information.

The i.LINK™ cables that are compatible with your VAIO desktop include cables with the following part numbers: VMC-IL4415, VMC-IL4435, VMC-IL4615, VMC-IL4635, VMC-IL6615, and VMC-IL6635. Sony computer supplies, accessories and peripherals can be purchased from your local retailer or from the Sony website:

<http://www.sonystyle-europe.com>

- ❑ **Connecting a digital video camera recorder (page 46)**
- ❑ **Connecting two VAIO computers (page 47)**

 An i.LINK™ connection with other compatible devices is not fully guaranteed.

You are strongly advised to use only Sony i.LINK™ cables, as using other brands may cause problems with the i.LINK™ devices.

The i.LINK™ connection varies depending on the software applications, operating system and i.LINK™ compatible devices you use. Refer to the documentation that came with your software for more information.

Check the working conditions and OS compatibility of i.LINK™-compatible PC peripherals (HDD, CD-RW drive etc.) before you connect them to your VAIO desktop.

Connecting a digital video camera recorder

To connect a digital video camera recorder, proceed as follows:

- 1 Plug one end of the i.LINK™ cable (not supplied) into the i.LINK™ port of the computer and the other end into the DV-Out port on your digital video camera recorder.
- 2 Launch the DVgate application (see your **Software Guide** for more information).

 On Sony digital video cameras, ports labelled **DV Out**, **DV In/Out** or **i.LINK™** are i.LINK™-compatible.

The Sony digital video camera recorder is an example; your digital video camera recorder may need to be connected differently.

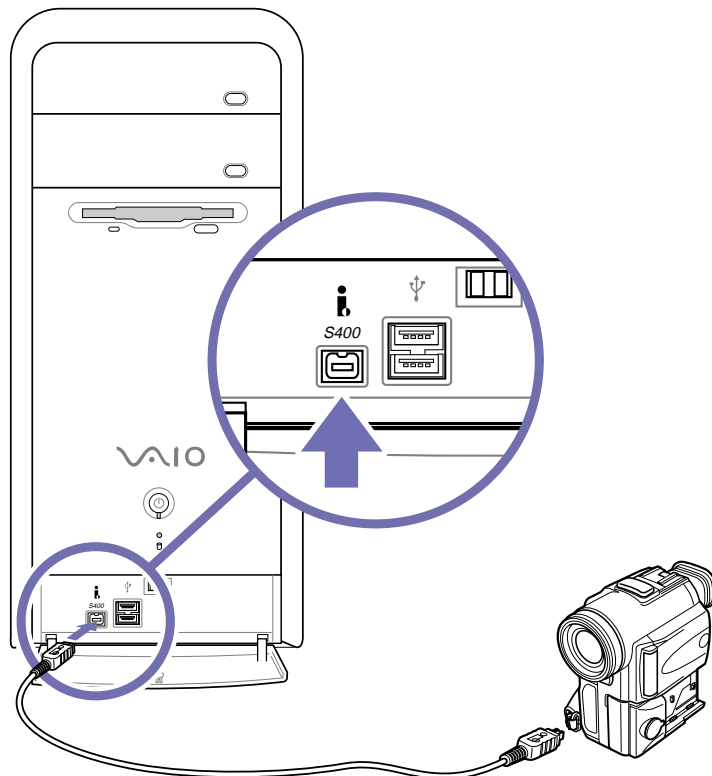

Connecting two VAIO computers

If you have administrator rights on your computer, you can connect your VAIO desktop to another VAIO computer using an i.LINK™ cable (not supplied). With the software delivered with your VAIO desktop, you can copy, edit or delete files on another VAIO computer that also has Windows® XP installed.

You can also print a document on a printer connected to another VAIO computer.

To connect your VAIO desktop to another VAIO computer, proceed as follows:

- 1 Insert one end of the i.LINK™ cable into one of the i.LINK™ ports on the main unit of the VAIO desktop.
- 2 Connect the other end to the other VAIO computer.

 This illustration may not correspond to the configuration of your model. Please check the section **Back Panel** of your printed **Specifications** sheet to see where the ports are exactly.

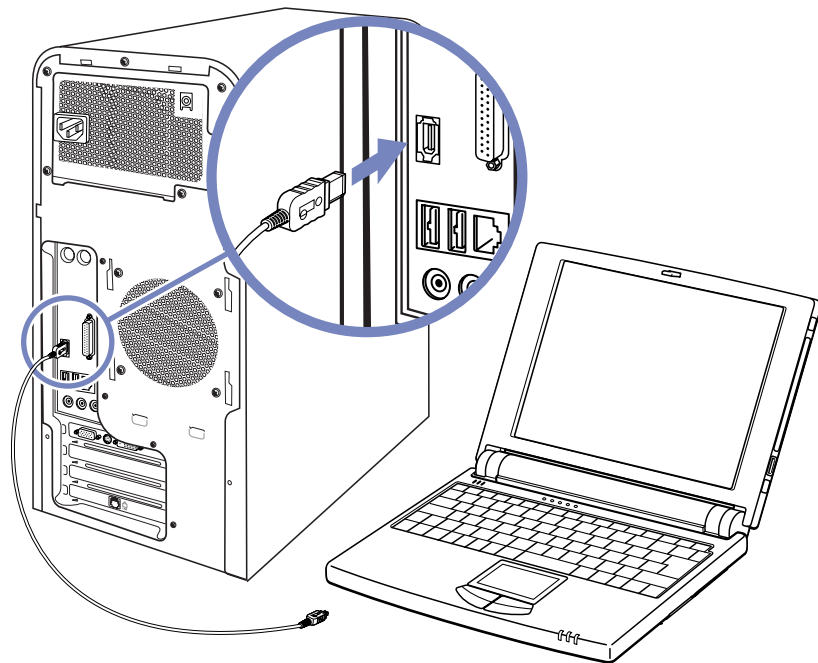

Connecting to a network

Your computer comes with a built-in Ethernet interface.

To connect to a network, proceed as follows:

- 1 Connect your 10BASE-T/100BASE-TX Ethernet cable (not supplied) to the Ethernet port on the back of the computer. The sticker covering the Ethernet port is there to remind customers in Germany not to insert an ISDN cable (see caution below). You can remove the sticker to use the Ethernet function.
- 2 Go to **Start**, right-click **My Computer** and select **Properties**.
- 3 Click the **Hardware** tab and select **Device Manager**.
The **Device Manager** screen appears with the list of devices.
- 4 Under **Network Adapters**, right-click the name of the adapter.
- 5 Click **Properties**.
- 6 Under **Device Usage**, select **Use this device (enable)**.
- 7 Click **OK** to close the **Properties** window.
The Ethernet connection is now enabled.

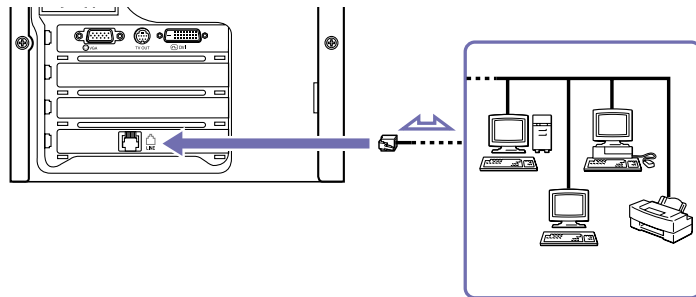

! Connect only 10BASE-T/100BASE-TX cables to the Ethernet port. Using other cables or a telephone cable may cause a malfunction, excessive heat or even fire in the port. If using this computer in Germany, please make sure you do not use an ISDN cable. It is physically very similar, but its higher voltage of 12V may destroy the motherboard inside the computer.



For more information about connecting your VAIO desktop to the network, please consult the Hardware troubleshooting section of the VAIO-Link website (<http://www.vaio-link.com>):

[How to troubleshoot network problems.](#)

For help on connecting to a network, see your network administrator.

This illustration may not correspond to the configuration of your model. Please check the section **Back Panel** of your printed **Specifications** sheet to see where the ports are exactly.

Getting help

This section describes how to get help and support from Sony, as well as troubleshooting tips for your computer.

Sony's support options

Sony offers you several support options for your computer.

Sony documentation

Please see the section **Documentation pack (page 8)** for details on the printed and online documentation delivered with your computer, as well as further sources of reference.

Other sources of information

- ❑ **Online Help files:** Before contacting VAIO-Link, try to solve the problem by reading the user guides and help files supplied with the peripherals or software.
- ❑ **VAIO-Link website**, which you can access if you have any problems with your computer:
<http://www.vaio-link.com>



You will need to set up and configure your VAIO's internal modem before you can visit the VAIO-Link website.

e-Support

What is e-Support?

You have searched our user guides and website (www.vaio-link.com) but have not found an answer to your question/issue? e-Support is the ideal solution for you!

Our e-Support Web Portal is an interactive website on which you can submit any technical query you may have regarding your VAIO and receive answers from our dedicated support team.

Every submitted query will result in a unique 'case number' to ensure smooth communication between yourself and the e-Support Team.

Who can use e-Support?

All registered VAIO customers are entitled to unlimited access to the VAIO-Link e-Support Web Portal.

How can I access the e-Support portal?

When you register your VAIO computer online at Club-VAIO (www.club-vaio.com), you will automatically receive an email with the link to the e-Support Web Portal, your Customer ID and some basic explanation a few hours later.

All you need to do is activate your account by clicking on the provided link in the email.

You are now ready to create your first case!

You can access the e-Support Web Portal from any computer with an active Internet connection.

A complete help file is available on the e-Support Web Portal to help you use our e-Support Service.

Can I submit questions in my native language?

Since you are interacting with our e-Support Team through a portal, which connects you directly to our central database, e-Support will only accept and deal with queries submitted in English.

Can I submit my questions at any time?

Yes, you can submit your questions 24/7, but please keep in mind that our e-Support Team can only treat your queries from Monday till Friday between 8am and 6pm.

Is there a cost involved for using e-Support?

No, this is a complete free of charge service offered to all registered VAIO customers!

How do I know when the e-Support Team has handled my query/case?

As soon as your case has been dealt with by our e-Support Team, you will receive an email, notifying you that your case has been updated.

Troubleshooting

This section describes how to solve common problems you might encounter when using your VAIO desktop. Many problems have simple solutions. Please try these suggestions before contacting VAIO-Link or your local Sony dealer.

You are recommended to print out this section and keep it for future reference.

- About the computer and software ([page 54](#))
- About the display ([page 58](#))
- About discs and floppy disks ([page 60](#))
- About sound ([page 64](#))
- About the modem ([page 66](#))
- About peripherals ([page 67](#))
- About digital video captures and DVgate ([page 71](#))
- About i.LINK™ devices ([page 72](#))

About the computer and software

My computer does not start

- ❑ Check that the computer is plugged directly into a power source (without an extension cord) and that it is turned on.
- ❑ Check that the monitor is properly connected to the main unit, plugged into a power source and turned on. Check that the brightness and contrast controls are adjusted correctly.
- ❑ Check the power socket is working by testing it with another device (e.g. a lamp or radio).
- ❑ Check that the power indicator on the front panel of the computer indicates that the power is on.
- ❑ If you cannot start Windows®, make sure there is no disk in the floppy disk drive.
- ❑ Confirm that the power cord and all cables are connected firmly.
- ❑ If you have plugged the computer into a UPS (Uninterruptible Power Supply), make sure the UPS is turned on and works.
- ❑ Unplug all external devices and cables, including the Internet connection.
- ❑ Remove any extra memory modules you may have inserted since purchase.
- ❑ If the message **Press <F1> to resume, <F2> to set up** appears at the bottom of the display, you need to initialise the BIOS (Basic Input/Output System).
- ❑ Moisture condensation may have occurred. Do not use the computer for at least one hour and then turn it on.

The message 'Press <F1> to continue, <F2> to enter setup' appears at startup

This message is telling you to initialise the BIOS (Basic Input/Output System).

To do so, proceed as follows:

- 1 Turn off the computer.
- 2 Remove any peripheral devices connected to the computer.

- 3 Turn on the computer and press **<F2>** when the **Sony** logo appears. The BIOS setup menu screen appears.
- 4 Use the keyboard's arrow keys to select the **Exit** menu.
- 5 Press **<F5>** or use the arrow keys to select **Load Setup Defaults** and then press **<Enter>**. The message **Load Setup Defaults?** appears.
- 6 Make sure that **Yes** is selected and then press **<Enter>**.
- 7 Press **<F10>** to exit, or use the arrow keys to select **Save Changes** and then press **<Enter>**. The message **Save configuration changes and exit now?** appears.
- 8 Make sure that **Yes** is selected and then press **<Enter>**.

My computer does not shut down

It is recommended that you shut down your computer using the **Turn Off Computer** command on the Windows® **Start** menu. Using other methods, including those listed here, may result in loss of unsaved data.

If the **Turn Off Computer** command does not work properly, proceed as follows:

- 1 Shut down the computer by pressing **<Alt>+<F4>**. The **Turn off computer** box appears. Select **Turn Off**.
- 2 If this does not work, press **<Ctrl>+<Alt>+<Delete>**. The **Task Manager** dialog box appears. Click **Shut Down**, then **Turn Off**.
- 3 If this does not work, press the power button and hold it for at least six seconds. This turns off the power.
- 4 If you really have tried everything, unplug the computer from the mains.

My system is running slowly

- ❑ The system response time varies, depending on the number of applications that are open and running. Close any application that you are not currently using.

- ❑ Increasing the system memory may also help. The computer has two memory slots. For memory upgrades, use only PC2100 (DDR266) DDR-SDRAM DIMM or PC2700 (DDR333) DDR-SDRAM DIMM modules (depending on your model). For information on installing memory, please see the section **Upgrading memory (page 77)**.
- ❑ Another option is to defragment the hard drive. See the Windows® Help files for details or contact your system administrator if you have one.

My computer or software program is not responding

If you suspect one application is locking your system, you can try to stop it, as follows:

- 1 Press **<Ctrl>+<Alt>+<Delete>** simultaneously.
The **Windows Task Manager** screen appears.
- 2 Scroll down until you see an application with the status **Not responding**.
- 3 Select this application from the list and click **End Task**.
Windows® tries to close the application.
If it fails to do so, a second dialog box appears.
- 4 Select **End Task** again.

If the above method does not work or you do not know which application is locking your system, shut down the computer, as follows:

- 1 Click the **Start** button.
 - 2 Select **Turn Off Computer**, and then **Turn off** in the dialog box that appears.
- ❑ If the above method does not work, press the power button and hold it for at least six seconds. This turns off the power, risking the loss of unsaved data.
 - ❑ If your computer locks up while playing a disc, stop the disc by pressing the eject button on the disc drive, then restart your computer.

- ❑ If the message **Application not responding appears**, click **End Now**. Please be warned that you will lose unsaved data.
- ❑ If this happens regularly:
 - ❑ Contact the software publisher or designated provider for technical support.
 - ❑ Make sure the software is compatible with your equipment and operating system.
 - ❑ Try reinstalling the software.

Windows® locks up during shutdown

There are many reasons why the Windows® operating system may not shut down properly, including incompatible or conflicting drivers, damaged files, or non-responsive hardware.

To search Windows® Help for troubleshooting information, proceed as follows:

- 1 From the **Start** menu, select **Help and Support**.
- 2 Click **Fixing a problem**.
- 3 Use the browse and search functions to find a solution.

About the display

My monitor does not display anything

- Check that the computer is plugged into a power source and that it is turned on.
- Check that the monitor is plugged into the computer and to a power source, and turned on.
- Check that the power indicators on the main unit and on the screen are on.
- Adjust the brightness of the monitor.
- The computer display may be in Standby mode. Press any key to activate the display.
- If you want to use a digital display (DVI), you cannot use it at the same time as a VGA. Either disconnect the VGA display and reboot your computer, or change the settings as described under **Connecting an external display (page 37)**.

The window I have just closed is still on the screen

- Press **<F5>** to refresh the screen, or
- Press the Windows® key + **<D>** twice to clean up the screen.

I cannot find the Windows® taskbar

- Check that the taskbar is not hidden or minimised.
- Move the cursor to each edge of the screen to retrieve the taskbar.

To change the default view of the taskbar and the **Start** menu, proceed as follows:

- 1 Click **Start**, and select **Control Panel**.
- 2 Click **Appearance and Themes**, then **Taskbar and Start Menu**.
The **Taskbar and Start Menu Properties** dialog box appears, where you can make the required settings.

I want to change the resolution of my display

To change the resolution of your display, proceed as follows:

- 1 From the **Start** menu, select **Control Panel**.
- 2 Click **Appearance and Themes**, then **Display**.
The **Display Properties** dialog box appears.
- 3 Select the **Settings** tab.
- 4 Move the **Screen resolution** slider to change the resolution.
- 5 Click **OK**.

About discs and floppy disks

- ❑ Make sure the computer is turned on and press the eject button on the drive.
- ❑ If the eject button is not working, click **Start**, and select **My Computer**. Right-click the optical disc drive and select **Eject**.
- ❑ Make sure the computer is not in **Standby** or **Hibernate** mode.

I cannot play a disc

- ❑ After inserting the disc, wait for a few seconds for the system to detect it before you try to access it.
- ❑ Make sure the label of the disc is facing up.
- ❑ If the disc requires software, make sure the software is installed according to the instructions of the program.
- ❑ Check the volume of your speakers.
- ❑ Clean the disc with an appropriate cleaner.
- ❑ There may be condensation in the drive. Remove the disc and leave the drive open for approximately one hour.
- ❑ If a region code warning appears when you are using the DVD player, it could be that the DVD you are trying to play is incompatible with the DVD drive on your VAIO desktop. The region code is listed on the packaging of the disc.
- ❑ If you hear sound but cannot see a picture, your computer's video resolution may be set too high. For best results, change the resolution in the **Control Panel - Display** to a lower resolution.
- ❑ If you see the video but cannot hear sound, check all of the following:
 - ❑ Make sure the mute setting is off in your DVD player software.
 - ❑ Check the volume settings under **Control Panel - Sounds, Speech and Audio Devices**. If you have connected external speakers, check the volume settings for your computer speakers and check the connections between your speakers and the computer.

- ❑ In the **Device Manager**, check that the correct drivers are installed properly. To display the **Device Manager**, Go to the **Control Panel**. Click **Performance and Maintenance**, and then the **System** icon. In the **System Properties** dialog box, click the **Hardware** tab.
- ❑ A dirty or damaged disc may cause the computer to 'hang' while it tries to read the disc. If necessary, reboot the computer, remove the disc and then check that it is not dirty or damaged.
-  On your computer, the default DVD region code is 2, which is the region code for European DVDs. Do not change this setting using the Region Code Change function in Windows®, or any other software application. System malfunctions originating from the user changing the DVD region code are beyond the scope of your warranty and will result in service charges for repair.

I cannot record to DVD (for models with a DVD writer)

You can find general troubleshooting points below, but the VAIO-Link website has more detailed advice, including links to help files and DVD software manuals. Always check the website if you are having difficulties:

www.vaio-link.com

If you are having problems with general recording, perform the following checks:

- ❑ Are you using the correct DVD recordable media?
Please check which DVD recordable format is compatible with your VAIO built-in DVD recorder: DVD-R / DVD-RW / DVD+R / DVD+RW. Please note the possibility that some brands of DVD recordable media do not work.
- ❑ Is there any third-party DVD-recording software installed on the VAIO? If so, remove all third-party DVD-recording software from the computer.
- ❑ Are you able to read regular data/music DVDs? Check if you are able to read pre-recorded DVD media. Please note that combined drives (i.e. DVD recordable drive and CD reader/writer in one) tend to be more sensitive than regular DVD drives (for example, a scratched DVD will work fine in a DVD drive but cannot be read in a combined drive).

- ❑ Is the DVD recorder properly detected and functioning according to the Device Manager? Go to **Start**, right-click **My Computer** and select **Properties**. Click the **Hardware** tab and select **Device Manager**. Open **DVD/CD-ROM drives** in the tree list. Please note that the name of the drive can differ for each model.
If an exclamation mark is shown next to the drive or if **DVDRW** is not mentioned for the drive, uninstall the DVD recorder from Device Manager and restart the computer. Please note that the drivers used are generic Windows® drivers and are not available on the VAIO Recovery and Documentation Disc or the VAIO-Link website.
- ❑ Check www.vaio-link.com for the following:
 - ❑ If your VAIO is updated to the latest BIOS (Basic Input/Output System).
 - ❑ If a firmware update is available for your DVD recordable drive.
- ❑ Perform a system recovery on the VAIO. Make sure you aware of the consequences of this action beforehand. See the section **Recovering the system** of the guide **Troubleshooting / Using the VAIO Recovery and Documentation Disc**.
- ❑ If you are still unable to record to DVD, contact VAIO-Link directly.

My floppy disk drive cannot write to a disk

- ❑ The floppy disk may be write-protected. Disable the write-protect feature or use a disk that is not write-protected.
- ❑ Check that the disk is properly inserted into the floppy disk drive.

When I double-click an application icon, a message such as 'You must insert the application CD into your drive' appears and the software does not start

- ❑ Some titles require specific files that are located on the application disc. Insert the disc and try starting the program again.
- ❑ Make sure you place the disc in the tray with the label side facing upwards.

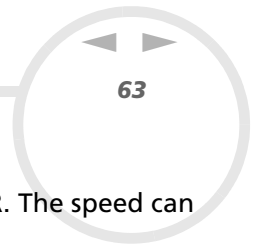

The recording and reading speed of CDs / DVDs is slow

Generally, the speed of a CD/DVD-RW is slower than that of a CD/DVD-ROM, or CD/DVD-R. The speed can also vary depending on the type of format.

About sound

My speakers are not producing any sound

- ❑ If you are using an application that has its own volume control, check that the volume is turned up.
- ❑ Check the volume controls in Windows® and in Windows® Media Player.
- ❑ Check that the speakers are connected correctly and turned on, and that the power cable is plugged into the mains (see the printed **Getting Started** brochure or the back of the **Specifications** sheet for connection details).

My microphone is too sensitive to background noise

If you find there is too much background noise when you record sound, you can adjust the microphone gain.

To adjust the microphone settings, proceed as follows:

- 1 In the **Control Panel**, choose **Sounds, Speech and Audio Devices**.
- 2 Click **Sounds and Audio Devices**.
The **Sounds and Audio Devices Properties** box appears.
- 3 Click the **Voice** tab.
- 4 Under **Voice recording**, click **Volume**.
The **Recording Control** dialog box appears.
- 5 In the **Options** menu, select **Properties**.
The **Properties** dialog box appears.
- 6 Change the setting in the **Adjust volume for** dialog box from **Playback** to **Recording**, and then click **OK**.
- 7 Reduce the microphone level by moving the slider control.

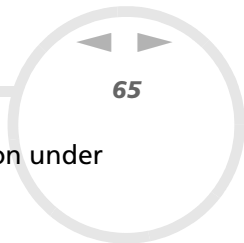

- 8 In the **Options** menu, select **Advanced Controls**, and then click the **Advanced** button under **Microphone - Balance**.
The **Advanced Controls for Microphone** dialog box appears.
- 9 Deselect the **Microphone Boost** check box, and then click **Close**.
- 10 Close the **Recording Control** dialog box.
The unwanted noise should now be cleared.

About the modem

My internal modem does not work or cannot establish a connection

- Check that the phone line is plugged into your computer.
- Make sure that the modem is the only device connected to your phone line.
- Check that the phone line is working. You can check the line by plugging in an ordinary phone and listening for a dial tone.
- Check that the phone number the program is dialling is correct. The modem dialling mode may be incompatible with your telephone line.
- The modem may not work properly if you are with a **Private Automatic Branch eXchange (PABX)**.
- In the **Phone and Modem Options** dialog box (**Control Panel / Phone and Modem Options**), check that your modem is listed in the **Modems** tab, and that the location information is correct on the **Dialing Rules** tab.



If you do not see the **Phone and Modem Options** icon, click **Switch to Classic View** on the left side.

My modem connection is slow

Many factors influence modem connection speed, including telephone line noise or compatibility with telephone equipment (such as fax machines or other modems). If you think your modem is not connecting properly to other PC-based modems, fax machines, or your Internet Service Provider, check the following:

- Have your phone company check that your phone line is free from any line noise.
- If your problem is fax-related, check that there are no problems with the fax machine you are calling and that it is compatible with fax modems.
- If you are having a problem connecting with your Internet Service Provider, check that the ISP is not experiencing technical problems.
- If you have a second phone line available, try connecting the modem to that line.

About peripherals

My mouse does not work

- ❑ If you are using the supplied PS/2 mouse, you must connect it **before** you turn on your computer.
- ❑ If you are using an optional Sony USB mouse, check that the appropriate driver and software are properly installed.
- ❑ Check that the mouse is plugged into the mouse connector.
- ❑ Note that the scrolling features work only with programs that use scroll bars. Some programs do not support features usually available with the central wheel.
- ❑ There may be dust or dirt inside the mouse mechanism.

To clean the mouse, proceed as follows:

- 1 Turn off the computer and turn the mouse upside down.
- 2 Remove the mouse ball cover by turning the ring clockwise as indicated by the arrows.
- 3 Turn the mouse upright and drop the mouse ball into your hand.
- 4 Using a piece of sticky tape, remove any dirt or dust on the mouse ball and inside the ball socket.
- 5 Put the mouse ball back into the socket and replace the cover.
- 6 Secure the cover by turning the ring anti-clockwise.

 This cleaning procedure does not apply to optical mouse devices.

If you are using an optical mouse:

- ❑ Do not use the mouse on a reflective surface (such as a mirror) or transparent surface (such as glass).

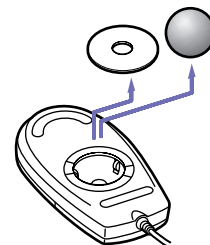

- ❑ Some surfaces do not allow the sensor to function properly because the irregularities are too small to be detected. The best surfaces reflect but scatter light; an example is a blank sheet of white drawing paper. Otherwise, use a standard mouse pad.

My mouse needs to be set up for left-hand use

To set your mouse up for left-handed users, proceed as follows:

- 1 Go to **Start**, select **Control Panel**, then click the **Printers and Other Hardware** option.
- 2 Click the **Mouse** icon.
The **Mouse Properties** dialog box appears.
- 3 In the **Buttons** tab, select the option button next to **Switch primary and secondary buttons**.
- 4 Click **OK**.
The new mouse settings are now in place.

My keyboard does not work properly

- ❑ If using the keyboard delivered with your computer, check that it is plugged into the PS/2 keyboard port on the back of the unit.
- ❑ PS/2 connections are not 'plug and play', which means that if you connect the PS/2 keyboard after starting your computer, it does not work. Shut down the computer and connect the keyboard before restarting the system.

I cannot use digital (DV) devices. The message 'DV equipment seems to be disconnected or turned off' appears.

- ❑ Check that the DV device is turned on and that the cables are properly connected.
- ❑ If you are using multiple i.LINK™ devices, the combination of the connected devices may cause unstable operation. If this is the case, turn off all connected devices and disconnect unused devices. Check the connection and then turn on the power again.

- ❑ You are strongly advised to use only Sony i.LINK™ cables, as using other brands may cause problems with the i.LINK™ devices.

How do I install a printer?

Always check the printer manufacturer's website for the latest drivers for Windows® XP Home Edition Service Pack 1 before proceeding. Some printers do not function properly without updated drivers. If the printer has a USB connection, the printer should be automatically installed.

To install a local printer, proceed as follows:

- 1 From the **Control Panel**, select **Printers and Other Hardware**, then **Printers and Faxes**.
- 2 Under **Printer Tasks**, click **Add a printer**.
- 3 Let the **Add Printer Wizard** guide you through the installation process.
- 4 Click **Finish**.
The printer is now installed.



This procedure applies for most, but not for all printers.

I cannot print

- ❑ Check that all the cables of the printer are properly connected.
- ❑ Check the cable to see if the pins/connectors are not bent or missing completely.
- ❑ Check the manual supplied with your printer for troubleshooting solutions.
- ❑ Try a printer self test (if available) to see if the printer itself is still working properly. For more information, please consult the manual supplied with your printer.
- ❑ Try reinstalling the printer. Some printers have a specific installation procedure. Please check the manual supplied with your printer.
- ❑ Check that your printer is correctly configured and that you have up-to-date drivers. If necessary, contact your dealer.

The default setting for the printer port mode is correct for most printers. If you cannot print, try changing the printer port mode, as follows:

- 1 Restart your computer.
- 2 When you see the **Sony** logo, press **<F2>**.
The BIOS setup menu screen appears.
- 3 Use the keyboard's arrow keys to select the **Advanced** menu.
- 4 The documentation delivered with your printer should give you the relevant port option.
- 5 **Select I/O Device Configuration** or **On board device Configuration**, then press the **<Enter>** key.
- 6 Select **Parallel Port Mode**, then press the **<Enter>** key.
- 7 Select a printer port option using the arrow keys, then press **<Enter>**.
- 8 Press **<F10>** and save the new configuration.
Your computer restarts.

If you still cannot print, try resetting the printer connection, as follows:

- 1 Click the icon of the printer installed on your computer.
- 2 In the **Printer Tasks** menu, which has now expanded, click **Set printer properties**.
- 3 Have a look through the different tabs and check for abnormalities that you may be aware of. If you are unsure, check with the printer manufacturer's support service about the correct installation for the printer.
- 4 Restart your computer.

About digital video captures and DVgate

When I record images to a digital video device using DVgate, my system displays the message 'Recording to DV device failed. Check the power and cable connections to the devices and try again'

Close all open applications and restart your computer. Frequently recording images to a digital video device while using DVgate sometimes causes this error.

About i.LINK™ devices

My i.LINK™ device does not appear on the desktop

To see the i.LINK™ device icon on the desktop, proceed as follows:

- 1 Turn off and disconnect your i.LINK™ device.
- 2 Reconnect your device.
- 3 Turn on the power on the device again.
The icon should now appear on the desktop.

The connected i.LINK™ device is not recognised

- Disconnect the i.LINK™ device, then connect it again.
- You are strongly advised to use only Sony i.LINK™ cables, as using other brands may cause problems with the i.LINK™ devices.

I cannot establish an i.LINK™ connection between two VAIO computers

- You must have administrator rights on your computer to be able to link the two.
- Disconnect then reconnect the i.LINK™ cable.
- If you still have no connection after waiting for a while, restart both computers.
- If either computer has just returned from a power saving mode, the connection may be affected. In this case, make sure you perform a full restart before connecting them.
- Check that both units are in the same workgroup, and that the **Sharing** option is enabled.

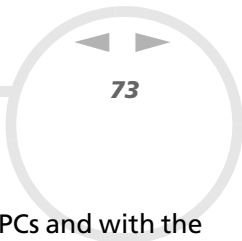

Upgrading your VAIO computer

The following procedures assume familiarity with the general terminology associated with PCs and with the regulatory compliance required for modifying electronic equipment.

Observe proper safety precautions at all times.

Your VAIO desktop and memory modules use high precision components and electronic connector technology. To avoid the invalidation of your guarantee by mishandling, it is recommended that:

You contact your local Sony dealer to install any new internal hardware components.

You do not install memory modules yourself, if you are not familiar with upgrading memory on a computer.

Please contact VAIO-Link if you need assistance.

- ! Always switch the power off before you open the system. Otherwise, damage may occur to the integrated circuits in your computer.
- ! Electrostatic discharge (ESD) can damage disk drives, add-on cards, and other components. Follow the procedures here only at an ESD workstation. Otherwise, do not work on a carpeted area and do not handle materials that produce or hold static electricity, such as cellophane wrappers. Ground yourself by keeping constant contact with an unpainted metal part of the unit while carrying out any of these procedures.

Removing the cover

To remove the cover from the main unit, proceed as follows:

- 1 Shut down your computer and disconnect all peripheral devices, such as your printer.
- 2 Unplug the computer from the mains.
- 3 Wait until the computer cools down.
The inside of the main unit becomes very hot during operation. Wait for about one hour for the computer to cool down before opening the unit.
- 4 Position the main unit so the back panel is facing you.
- 5 Unscrew the three cover release screws located on the edges of the back panel, and set them aside.
The cover is released.

 This illustration may not correspond to the configuration of your model. Please check the section **Back Panel** of your printed **Specifications** sheet to see where the ports are exactly.

- 6 Slide the cover towards the back of the unit to remove it.

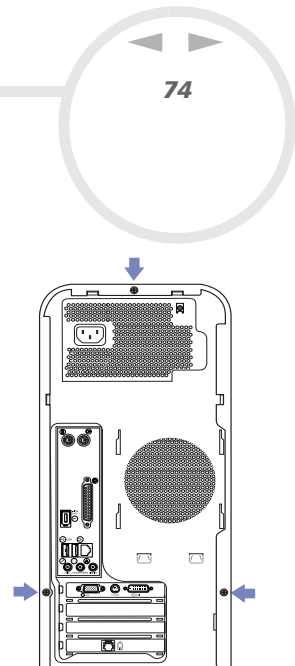
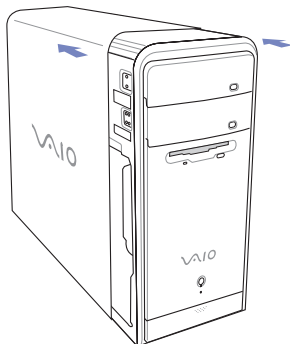

Inserting a PCI add-on card

Your computer has open PCI expansion slots. These slots enable you to install an add-on card to expand the functionality of your system.

When you remove a slot cover to install an add-on card, you may have to temporarily remove other components.

Add-on card configuration can vary.

To insert an add-on card, proceed as follows:

- 1 Shut down your computer and turn off all peripheral devices, such as your printer.
- 2 Unplug your computer and any peripheral devices.
- 3 Remove the cover as described in **Removing the cover (page 74)**.
- 4 Locate an available expansion slot.
- 5 Remove the screw, and then remove the slot cover, as shown (may vary from actual configuration):

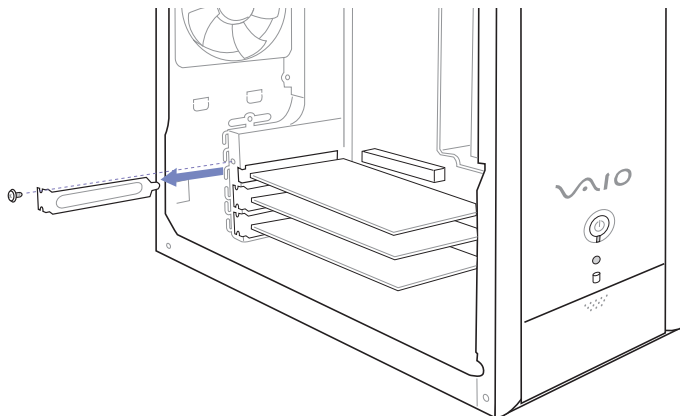

- 6 Install the add-on board by sliding it into the expansion slot and secure it with the screw from the expansion slot cover, as shown (may vary from actual configuration):

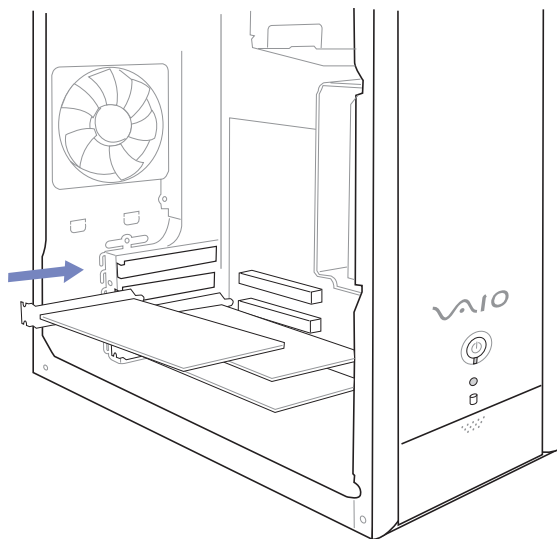

- 7 Attach any internal cables that the board requires (see the manual that came with the add-on board).
 - 8 Replace the side cover as described in **Replacing the cover (page 81)**.
 - 9 Reconnect all peripheral devices and the power cord, and then turn on the computer.
-  Make sure you observe the proper safety precautions when you add boards to your VAIO computer.

Upgrading memory

In the future, you may want to upgrade the memory installed on your VAIO by replacing / adding memory modules. However, we recommend that you do not install them yourself unless you are familiar with upgrading memory on a computer.

For memory upgrades, use only PC2100 (DDR266) DDR-SDRAM DIMM or PC2700 (DDR333) DDR-SDRAM DIMM modules (depending on your model).

Be careful when adding memory yourself. Mistakes on installation or removal of the memory module may cause a malfunction.

Electrostatic discharge can damage electronic components. Before touching a memory expansion board, remember the following:

- ❑ Handle the memory module gently.
- ❑ The procedures described in this document assume familiarity with the general terminology associated with personal computers and with the safety practices and regulatory compliance required for using and modifying electronic equipment.
- ❑ Disconnect the system from its power source and from any telecommunication links, networks, or modems before you open the system. Failure to do so may result in personal injury or equipment damage.
- ❑ Electrostatic Discharge (ESD) can damage memory modules and other components. Install the memory module only at an ESD workstation. If such a station is not available, do not work in a carpeted area, and do not handle materials that produce or hold static electricity (cellophane wrappers, for example). Ground yourself by maintaining contact with an unpainted metal portion of the chassis while performing the procedure.
- ❑ Do not open the memory module package until you are ready to install the module. The package protects the module from ESD.
- ❑ Use the special bag delivered with the memory module, or wrap the module in aluminium foil to protect it from electrostatic discharge.



Do not place the memory module in places subject to:

- Heat sources such as radiators or air ducts,
- Direct sunlight,
- Excessive dust,
- Mechanical vibration or shock,
- Strong magnets or speakers that are not magnetically shielded,
- Ambient temperature of more than +35°C or less than +5°C,
- High humidity.

! Introducing any liquids or any foreign substances or objects into the memory slots, or other internal components of the computer, will result in damage to the computer and any repairs will be out of warranty.

Adding / replacing a memory module

If you are not familiar with upgrading memory on a computer, we highly recommend that you contact your dealer.

To add or change a memory module, proceed as follows:

- 1 Shut down the computer, unplug it, and remove any peripheral devices.
- 2 Wait for the computer to cool down, then open the unit (see **Removing the cover (page 74)**).
- 3 Gently place the unit on its side.
- 4 To remove an existing memory module, release the end latches and gently lift out the module, as shown (may vary from actual configuration).
- 5 To insert a new memory module, remove it from its anti-static package, handling it only by the edges.
- 6 Locate the notch on the bottom edge of the memory module.
- 7 Align the memory module over the slot, making sure the module is facing the correct way.
- 8 Press evenly against the memory module's upper corners. The end latches snap into position automatically.
- 9 Reinstall any add-on cards or components you removed.
- 10 Replace the cover as described in **Replacing the cover (page 81)**.

 There is only one correct way to insert the memory module. Make sure the rivet of the module is lined up with the connector.

! Use only PC2100 (DDR266) DDR-SDRAM DIMM or PC2700 (DDR333) DDR-SDRAM DIMM modules (depending on your model).

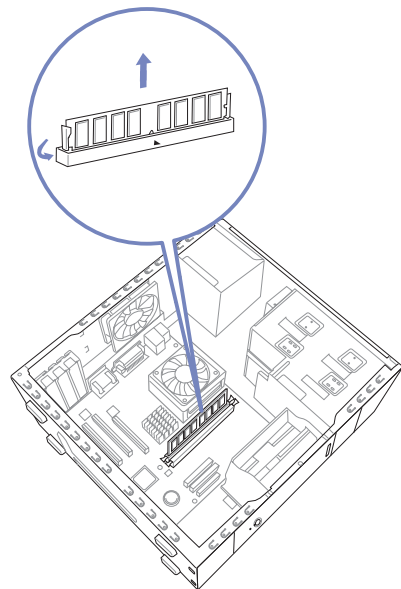

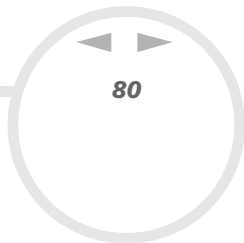

Viewing the amount of memory

To view the amount of memory, proceed as follows:

- 1 Turn on the computer.
- 2 Click the **Start** button, point to **All Programs**, then **VAIO System Information**, and click **VAIO System Information** again.
You can view the amount of installed memory here.

Replacing the cover

To replace the cover, proceed as follows:

- 1 Align the cover to the frame of the unit.
- 2 Slide the side cover firmly over the unit, sliding it forward until the cover snaps into place.
- 3 Replace the three release screws.

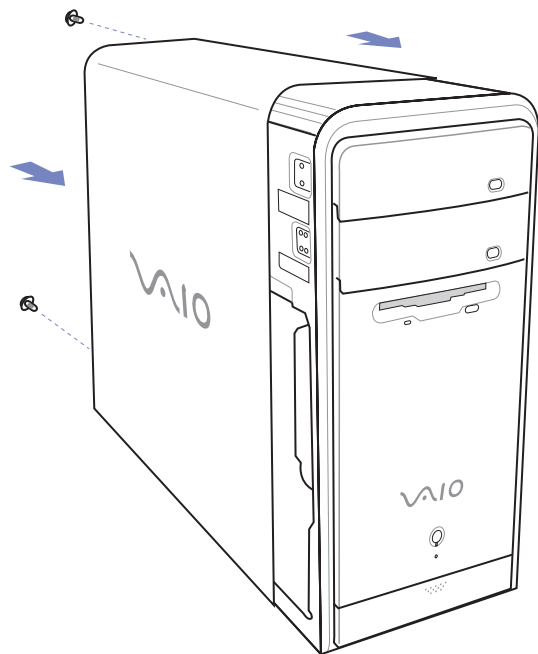

Precautions

This section describes safety guidelines and precautions to help you protect your computer from potential damage.

Please contact VAIO-Link if you need assistance.

- On handling the hard disk ([page 83](#))
- On using the power source ([page 83](#))
- On handling your computer ([page 84](#))
- On handling LCD screens ([page 85](#))
- On handling floppy disks ([page 86](#))
- On handling compact discs ([page 86](#))

On handling the hard disk

The hard disk has a high storage density and reads or writes data in a short time. However, it can be easily damaged by mechanical vibration, shock or dust.

Although the hard disk has the internal safety device to prevent losing data due to mechanical vibration, shock or dust, you should be careful when handling your computer.

To avoid damaging your hard disk:

- Do not subject your computer to sudden movements.
- Keep the computer away from magnets.
- Do not place your computer in a location subject to mechanical vibration or in an unstable position.
- Do not move your computer while the power is on.
- Do not turn off the power or restart the computer while reading or writing data to disk.
- Do not use your computer in a place subject to extreme changes in temperature.

 If the hard disk is damaged, the data cannot be restored.

On using the power source

- Your computer operates on 220-240V AC50/60Hz.
- Do not share the AC outlet with other high power-consuming equipment, such as a photocopier or shredder.
- You can purchase a power strip with a surge protector. This device prevents damage to your computer caused by sudden power surges, in an electrical storm, for example.
- Do not place heavy objects on the power cord.
- To disconnect the cord, pull it out by the plug. Never pull the cord itself.
- Unplug your computer from the wall outlet if you are planning to not use the computer for a long time.
- Make sure that the socket outlet is easily accessible

On handling your computer

- ❑ Handle the unit carefully while lifting, holding the unit by the bottom only. Do not attempt to lift the unit by using the floppy disk drive as a carry point.
- ❑ Clean the unit with a soft cloth, which is either dry or lightly moistened with a mild detergent solution. Do not use any type of abrasive pad, scouring powder, or solvent such as alcohol or benzene, as these may damage the finish of your computer.
- ❑ Should you drop a solid object or any liquid onto the computer, shut down your computer and then unplug it. You may want to have the computer checked by qualified personnel before operating it again.
- ❑ Do not drop the computer or place heavy objects on top of the computer.
- ❑ Do not place your computer in a location subject to:
 - ❑ Heat sources, such as radiators or air ducts
 - ❑ Direct sunlight
 - ❑ Excessive dust
 - ❑ Moisture or rain
 - ❑ Mechanical vibration or shock
 - ❑ Strong magnets or speakers that are not magnetically shielded
 - ❑ An ambient temperature of more than 35°C or less than 10°C
 - ❑ High humidity.
- ❑ Do not place electronic equipment near your computer. The electromagnetic field of your computer may cause a malfunction.
- ❑ Provide adequate air circulation to prevent internal heat from building up. Do not place your computer on porous surfaces such as rugs or blankets, or near material such as curtains or draperies that may block its ventilation slots.

- ❑ The computer uses high-frequency radio signals and may cause interference to radio or TV reception. Should this occur, relocate the computer a suitable distance away from the set.
- ❑ Use only specified peripheral equipment and interface cables; otherwise, problems may occur.
- ❑ Do not use cut or damaged connection cables.
- ❑ If the computer is brought directly from a cold location to a warm one, moisture may condense inside your computer. In this case, allow at least one hour before turning on your computer. If any problems occur, unplug your computer and contact VAIO-Link.
- ❑ Make sure you disconnect the power cord before cleaning the computer.
- ❑ As you may lose important data once your computer is damaged, you should back up your data regularly. Restore the original application programs from the VAIO Recovery and Documentation Disc.

On handling LCD screens

- ❑ Do not leave the LCD facing the sun as it can damage the LCD. Be careful when using the computer near a window.
- ❑ Do not scratch the LCD or exert pressure on it. This could cause malfunction.
- ❑ Using the computer in low temperature conditions may produce a residual image on the screen. This is not a malfunction. When the computer returns to normal temperature, the screen returns to normal.
- ❑ A residual image may appear on the screen if the same image is displayed for a lengthy period of time. The residual image disappears in a while. You can use a screensaver to prevent residual images.
- ❑ The screen becomes warm during operation. This is normal and does not indicate a malfunction.
- ❑ The LCD is manufactured using high-precision technology. You may, however, see tiny black points and/or bright points (red, blue, or green) that continuously appear on the LCD. This is a normal result of the manufacturing process and does not indicate a malfunction.
- ❑ Avoid rubbing the LCD screen, as this can damage the screen. Use a soft, dry cloth to wipe the LCD screen.

On handling floppy disks

- ❑ Do not open the shutter manually or touch the surface of the floppy disk.
- ❑ Keep floppy disks away from magnets.
- ❑ Keep floppy disks away from direct sunlight and other sources of heat.

On handling compact discs

- ❑ Do not touch the surface of the disc.
- ❑ Do not drop or bend the disc.
- ❑ Fingerprints and dust on the surface of a disc may cause reading errors. Always hold the disc by its edge and central hole, as shown.
- ❑ Proper care of the disc is essential to its continuous reliability. Do not use solvents such as benzine, thinning agents, commercially available cleaners or anti-static spray, as they may cause damage to the disc.
- ❑ For normal cleaning, hold the disc by its edge and use a soft cloth to wipe the surface from the centre out.
- ❑ If the disc is badly soiled, moisten a soft cloth with water, wring it out well, and use it to wipe the surface of the disc from the centre out. Wipe off any remaining moisture with a dry soft cloth.
- ❑ Never put stickers on discs. This will affect the use of the disc irreparably.

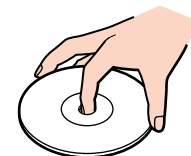

Glossary

This section refers to terms used in this manual and elsewhere in the VAIO world. These terms and definitions have been compiled to provide you with a better understanding of your VAIO computer.

<i>Term</i>	<i>Definition</i>
<i><F1> key</i>	The <F1> key gives you access to the online help of most software.
<i>10BASE-T/100BASE-TX</i>	Ethernet system providing data transfer rates of 10 Mbps (megabits per second) and 100 Mbps. The 100BASE-TX is a very direct derivative of 10BASE-T. Its 100 Mbps speed is achieved by simply sending the signal 10 times faster.
<i>ACPI</i>	Short for Advanced Configuration and Power Interface, a power management specification. ACPI enables the operating system to turn peripherals on and off and to control the amount of power given to each device attached to the computer. With ACPI, a CD-ROM player can be turned off by the operating system if it is not in use.
<i>BIOS</i>	An acronym for Basic Input/Output System. The BIOS is a program that enables the computer to start when you turn it on. It monitors the data stream between the operating system and the computer's hardware devices.
<i>CD-ROM</i>	Abbreviation for Compact Disc Read-Only Memory. A high-capacity optical disc, usually 650 MB in size, capable of being read from but not written to.
<i>CD-RW</i>	Short for Compact Disc-ReWriteable. Compact Disc that can be used to write or rewrite data to it. A CD-RW can be written to several times, a CD-R can only be written to once.
<i>CNR</i>	Short for Communication and Networking Riser. A hardware device that plugs into a motherboard and holds chips for functions like modems and audio devices.

<i>Term</i>	<i>Definition</i>
<i>CPU</i>	The CPU (Central Processing Unit) is the brains of the computer; it processes the instructions of your system's programs. The CPU is also known as the processor or microprocessor and can be found on the motherboard of your computer.
<i>CRT</i>	A cathode ray tube (CRT) is a specialized vacuum tube in which images are produced when an electron beam strikes a phosphorescent surface. Most desktop computer displays make use of CRTs. The CRT in a computer display is similar to the "picture tube" in a television receiver.
<i>DC In</i>	The Direct Current interface to which you connect your computer's AC adapter or power cable.
<i>Driver</i>	A driver is software enabling you to use hardware devices. For example, in order for you to be able to use a printer, you must first install its driver. Many drivers, such as the mouse driver, come with the operating system.
<i>DVD-ROM</i>	Short for Digital Versatile Disc. A type of read-only CD with a minimum capacity of 4.7 GB (maximum capacity can reach 17 GB). This high storage power makes it the ideal medium for storing films.
<i>DVD-RW</i>	A rewritable DVD, based on the DVD-R format, that can be used to write, erase and rewrite a program or other data approximately 1,000 times. See http://www.dvdrw.com for more information on the DVD-RW.
<i>DVD+RW</i>	The DVD+RW is a slightly different rewritable DVD format, backed by a group of companies known as the DVD+RW Consortium, which includes Sony. Its advantages include high-compatibility, high capacity and easy-to-use functionality. Like the DVD-RW, it can be rewritten about 1,000 times. However, a DVD+RW drive writes at a higher speed than a DVD-RW drive. See http://www.dvdplusrw.org for more information on the DVD+RW.

Term	Definition
<i>DVI</i>	Stands for Digital Video Interface. Accommodates analog and digital monitors with a single connector. Using a DVI connector and port, a digital signal that is sent to an analog monitor is converted into an analog signal. If the monitor is a digital monitor, such as a flat panel display, no conversion is necessary.
<i>Ethernet</i>	Ethernet is the most widely implemented local area network (LAN) technology. The Ethernet system called 10BASE-T provides data transfer rates of 10 Mbps (megabits per second). A more recent version of Ethernet, called 100BASE-T, provides data transfer rates of 100 Mbps. Gigabit Ethernet supports data rates of 1 gigabit (1,000 megabits) per second.
<i>EULA</i>	EULA (End-User Licence Agreement) is the name given to a licence governing the software on your computer. The EULA can be found in the Read this first (page 1) section at the beginning of the software guide or directly on the VAIO desktop.
<i>Help files</i>	Online Help files can be found within most software applications, usually under a Help menu. They contain specific information on the software in use and can be used together with the descriptions in your online Sony Software Guide .
<i>Hyper-Threading (not available on all models)</i>	Hyper-Threading is a brand new technology giving the performance of two chips in one. With it, your desktop can run two different applications simultaneously or run a single application much faster than it would on a standard one-processor box.
<i>i.LINK™</i>	i.LINK™ is Sony's version of the IEEE 1394 standard for high-speed digital serial interface. The standard is regarded in the audio/video and IT industries as the most suitable interface for connecting computers and digital audio/video devices (such as digital cameras etc.).
<i>ISP</i>	An ISP (Internet Service Provider) is a company which provides you with a user name, password and telephone number in order to connect to the Internet.
<i>L2 cache memory</i>	Cache memory is RAM-like memory that enables quick access to data that has already been read by the computer. L1 and L2 are levels of cache memory in a computer.

Term	Definition
<i>LAN</i>	A LAN (Local Area Network) is a group of computers connected together within a limited geographical area. It enables users to share devices (such as printers) and information using one processor or server.
<i>LCD</i>	Short for Liquid Crystal Display. Flat display technology using liquid crystals (and light polarisation) to provide sharp, flicker-free images on a screen comprised of millions of tiny cells. Colour can be produced by two basic techniques. Passive matrix is the less expensive of the two technologies. The active matrix technology (or TFT) produces better quality but is also more expensive.
<i>LED</i>	Short for Light-Emitting Diode. A semiconductor device that lights up when electricity passes through it.
<i>MAPI</i>	Short for Messaging Application Program Interface. A Microsoft Windows interface enabling you to send e-mail messages. It allows e-mail access and distribution among applications. MAPI-compatible applications include a Send Mail or Send in the File menu of the application.
<i>maximum RAM</i>	The maximum amount of RAM that your computer can contain. Once this amount is reached, you can no longer add additional RAM to your computer.
<i>Motherboard</i>	The motherboard is the main circuit board inside your computer. It holds the CPU, the BIOS, the memory and so on.
<i>MPEG</i>	MPEG or Moving Pictures Experts Group is a standard for audio-visual compression of video sequences. MPEG achieves high compression rates by storing only the changes from one frame to another. The decrease in data is generally imperceptible to the human eye. MPEG-1 was developed for digital storage of video and audio data on CD-ROM. MPEG-2 achieves better image and audio quality and is more targeted to TV broadcasting and DVD.

<i>Term</i>	<i>Definition</i>
<i>Operating system</i>	The operating system is software that manages all the other programs in a computer. It defines how the computer reads and writes information to its disks (and other hardware). Windows 2000, Windows Millennium Edition, Windows XP Professional and Windows XP Home Edition are examples of operating systems found on VAIOs.
<i>Partition</i>	A partition is a logical division of a computer's hard disk. A two-partition hard drive would typically contain C: and D: drives. Partitioning is particularly useful if you run more than one operating system or to clearly separate your data files from your installed software.
<i>PBX</i>	A PBX (Private Branch Exchange) is a private telephone network within an enterprise. Under this system, the calls between the enterprise members are local and the phone numbers are made up of 3 or 4 digits. Companies generally choose this phone system for internal communication because it is less expensive than the regular network. The users can still share a number of outside lines for making calls external to the PBX.
<i>PC Card</i>	A PCMCIA card. The term PC Card is more widely used than PCMCIA. See PCMCIA.
<i>Pixel</i>	A pixel (Picture Element) is a part of your screen. Your screen is made up of thousands of pixels, enabling you to see colours and pictures on it. The more pixels, the higher the resolution and the better the image quality.
<i>Processor</i>	The processor is the brains of the computer; it processes the instructions of your system's programs. The processor is also known as the CPU or microprocessor and can be found on the motherboard (see this word) of your computer.
<i>PS/2</i>	A type of mouse or keyboard port, stands for Personal System 2.
<i>PSTN</i>	PSTN (Public Switched Telephone Network) refers to the plain old telephone service, the national telecommunication networks implementing voice transmission by using analog signals.

Term	Definition
<i>RAM</i>	Short for Random Access Memory, the memory used to run programs and store data in current use. RAM is the fastest kind of memory to read from and write to. Information stored in RAM is lost when you turn off the computer. The higher the RAM capacity, the faster your current data can be processed.
<i>Resolution</i>	The degree of sharpness and clarity of an image. Resolution is expressed in pixels. Frequent computer screen resolutions are 640 x 480 pixels (VGA resolution; appropriate for a 14-inch screen), 800 x 600 (appropriate for a 15-inch screen), 1,024 by 768 (appropriate for a 17-inch screen), and 1,280 by 1,024. LCD displays usually use a higher resolution than a CRT of the same size.
<i>RGB signal cable</i>	RGB stands for Red, Green, Blue. A cable that requires separate transmission types for the three colours on the display.
<i>Service pack 1</i>	Windows XP Service Pack 1 (SP1) provides the latest security and reliability updates to the Windows XP operating system, and includes Internet Explorer 6 SP1. Windows XP SP1 is designed to ensure Windows XP platform compatibility with newly released software and hardware, and includes updates that resolve issues discovered by customers or by Microsoft's internal testing team.
<i>S-video</i>	S-video stands for separated video, a video technique separating colour from luminescence rendering clearer imaging, and requiring different cables and plugs than ordinary video.
<i>SDRAM</i>	Synchronous DRAM is a kind of dynamic random access memory running at a much higher clock speed than regular memory.
<i>Standard RAM</i>	The amount of RAM that is available on your computer when you purchase it.

<i>Term</i>	<i>Definition</i>
<i>System recovery</i>	A recovery process that enables you to recover the hard disk image initially available on the computer. Performing a system recovery is useful in the event of a serious system crash or if you want to modify the size of your partitions. You can find the system recovery on the VAIO Recovery and Documentation Disc. For more information, please refer to the Guide to Troubleshooting and Using the VAIO Recovery Documentation Disc .
<i>UPS</i>	A UPS (Uninterruptible Power Supply) is a device including a battery that protects your computer from data loss in the event of a power failure. The battery takes over as soon as a power interruption is detected. If you are using the computer when the power failure occurs, you have time to save all unsaved data and to shut down your computer.
<i>USB</i>	USB (Universal Serial Bus) is a hardware interface for attaching devices (such as a keyboard, mouse, joystick, scanner or printer). You can connect up to 127 devices to a USB port. The USB standard is Hot Plug and Play.
<i>VAIO</i>	Short for Video Audio Integrated Operation. Brand name covering Sony's PC products, peripherals, accessories and software. VAIO-branded items are all designed to make the best use of Sony's Audio-Video (AV) and Information Technology (IT) skills.
<i>VAIO Recovery and Documentation Disc</i>	Disc that enables a VAIO computer user to recover the hard disk image that was available when the computer was purchased. It also contains the online documentation. The disc is delivered with your computer. For more information, please refer to the Guide to Troubleshooting and Using the VAIO Recovery Documentation Disc .
<i>VGA</i>	The Video Graphics Array (VGA) display system has become the accepted minimum standard for PCs. You can choose between 16 colours at 640 x 480, or 256 colours at 320 x 200.
<i>WAN</i>	WAN (Wide Area Network) is a computer network connected together and covering a relatively large geographical area. This is in contrast to LAN, where the network is usually set up within one building or small geographical area. The largest existing WAN is the Internet.

**Term****Definition****XGA**

Short for Extended Graphic Array, a graphics standard. An XGA board can provide up to 1,024 x 768 pixels and supports up to 65 thousand colours.

Trademarks

Sony, BlueSpace NE, DVgate, Giga Pocket, HotKey Utility, Memory Stick Formatter, PicoPlayer, PictureGear Studio, Network Smart Capture, SonicStage, Sony Notebook Setup, Sony Style Imaging, UI Design Selector, VAIO Action Setup, VAIO Edit Components, VAIO Media, VAIO System Information, VAIO Web Phone, Memory Stick, the Memory Stick logo, VAIO and the VAIO logo are trademarks of Sony Corporation.

Microsoft, Internet Explorer, Windows Movie Maker, Windows Media Player, Windows XP Professional, Windows Home Edition and the Windows logo are trademarks or registered trademarks of Microsoft Corporation in the U.S. and other countries.

i.LINK is a trademark of Sony used only to designate that a product contains an IEEE1394 connection.

Adobe, Adobe Acrobat Reader, Adobe Premiere LE and Adobe Photoshop Elements are trademarks of Adobe Systems Incorporated.

QuickTime and the QuickTime logo are trademarks used under licence. QuickTime is registered in the U.S. and other countries.

RealOne Player is a trademark or registered trademark of RealNetworks, Inc. in the U.S. and other countries.

PowerPanel is a trademark of Phoenix Technologies Ltd.

Symantec Norton Antivirus is a trademark of Symantec Corporation.

EverQuest is a registered trademark of Sony Computer Entertainment America Inc.

Click to DVD is a trademark of Sony Electronics.

Drag'n Drop CD+DVD is a registered trademark of Easy Systems Japan Ltd.

WinDVD for VAIO is a trademark of InterVideo, Inc.

RecordNow is a trademark or registered trademark of VERITAS.

PowerDVD for VAIO is a trademark or registered trademark of CyberLink Corporation.

All other names of systems, products and services are trademarks of their respective owners. In the manual, the TM or [®] marks are not specified.

Specifications are subject to change without notice.

All other trademarks are trademarks of their respective owners.

Please see the printed Specifications sheet to see what software is available for your model.