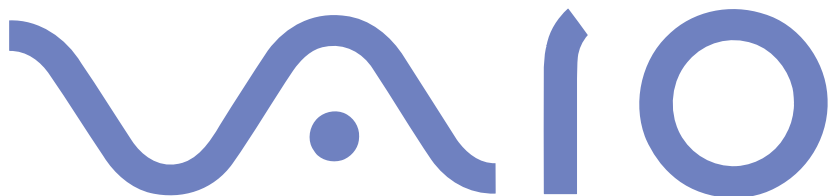

# *Sony VAIO Desktop User Guide*

**PCV-RX312**

The VAIO logo is rendered in a blue, stylized font. The 'V' is a thick, wavy line that curves down and then up. The 'A' is a solid blue circle. The 'I' is a thick vertical bar with a pointed top. The 'O' is a solid blue circle.

## Read this first

### Notice

© 2002 Sony Corporation. All rights reserved.

This manual and the software described herein, in whole or in part, may not be reproduced, translated, or reduced to any machine-readable form without prior written approval.

Sony Corporation provides no warranty with regard to this manual, the software, or other information contained herein and hereby expressly disclaims any implied warranties or merchantability or fitness for any particular purpose with regard to this manual, the software or such other information. In no event shall Sony Corporation be liable for any incidental, consequential, or special damages, whether based on tort, contract, or otherwise, arising out of or in connection with this manual, the software, or other information contained herein or the use thereof.

Sony Corporation reserves the right to make any modification to this manual or the information contained herein at any time without notice. The software described herein is governed by the terms of a separate user license agreement.

### Trademarks

Sony, DigitalPrint, DVgate, i.LINK and the i.LINK logo, Sony Style Imaging, MovieShaker, Smart Capture, UI Design Selector, VAIO Action Setup, VAIO System Information, SonicStage, Memory Stick and the Memory Stick logo, VAIO and the VAIO logo are trademarks of Sony Corporation.

i.LINK is a trademark of Sony used only to designate that a product contains an IEEE1394 connection.

Microsoft, Microsoft Works, Windows and the Windows logo, Windows Media and Outlook are trademarks or registered trademarks of U.S. Microsoft Corporation in the U.S. and other countries.

Adobe, Adobe Acrobat Reader and Adobe Photoshop Elements are trademarks of Adobe Systems Incorporated.

QuickTime and the QuickTime logo are trademarks used under license. QuickTime is registered in the U.S. and other countries.

RealPlayer is a trademark or registered trademark of RealNetworks, Inc. in the U.S. and other countries.

Symantec Norton Antivirus is a trademark of Symantec.

PowerDVD is a trademark or registered trademark of CyberLink Corporation.

All other names of systems, products and services are trademarks of their respective owners. In the manual, the ™ or ® marks are not specified.

Specifications are subject to change without notice.

## ENERGY STAR®

As an ENERGY STAR® Partner, Sony has determined that this product meets the ENERGY STAR® guidelines for energy efficiency. The International Energy Star® Office Equipment Program is an international program that promotes energy saving through the use of computers and their office equipment. The program backs the development and dissemination of products with functions that effectively reduce energy consumption. It is an open system in which business proprietors can participate voluntarily. The targeted products are office equipment such as computers, displays, printers, facsimiles and copiers. Their standards and logos are uniform among participating nations.

ENERGY STAR is a U.S. registered mark.



## Environmental information



Halogenated flame retardant is not used in cabinets.

Cushions formed by corrugated board are used in packaging.

## Safety information

### Owner's record

The model number and serial number are located on the back panel of your Sony VAIO desktop. Record the serial number in the space provided here. Refer to the model and serial number when you call VAIO-Link.

Serial number: \_\_\_\_\_

Model name: PCV-RX312

### Warnings

#### General

- Opening the unit, for whatever reason, could lead to damages that are not covered by the guarantee.
- To avoid electrical shock, do not open the cabinet. Refer servicing to qualified personnel only.
- To prevent fire or shock hazard, do not expose your VAIO desktop to rain or moisture.
- If reporting a gas leak, do not use the modem or a telephone in the vicinity of the leak.
- Avoid using the modem during a severe electrical storm.
- The power socket outlet you are using must be installed near the equipment and must be easily accessible.
- The magnetic properties of some objects can have serious consequences for your hard disk drive. They can erase the data on the hard disk drive and cause the computer to malfunction. Do not place your computer near or on any objects, which emit magnetic fields, mainly:
  - TV sets
  - Speakers
  - Magnets
  - Magnetic bracelets.



### *Audio/video*

- Audio and picture distortion may occur if this equipment is positioned in close proximity to any equipment emitting electromagnetic radiation.

### *Connectivity*

- Never install modem or telephone wiring during a severe lightning storm.
- Never install telephone jacks in wet locations unless the jack is specifically designed for wet locations.
- Be cautious when installing or modifying telephone lines.
- To disconnect your VAIO desktop completely from the mains voltage, unplug the power cable.
- Make sure that the socket outlet is easily accessible.

### *Optical disc drive*

The use of optical instruments can cause eye hazard. As the laser beam used in this product is harmful to the eyes, do not attempt any disassembling process. For servicing, refer to qualified personnel only.

## Regulatory information

Sony hereby declares that this product is in compliance with the essential requirements and other relevant provisions of European Directive 1999/5/EC (radio equipment and telecommunications terminal equipment Directive).



This product complies with EN 55022 Class B and EN 55024 for use in the following areas: residential, commercial, and light industrial.

This product has been tested and found compliant with the limits set out in the EMC Directive for using connection cables not longer than 3 metres (9.8 feet).

Before activating the built-in modem, please read the **Modem Regulations** flyer.

There is visible and invisible radiation when the optical disc drive is open: avoid direct exposure to the laser beam. The CD-RW and DVD-ROM disc drives are classified as CLASS 1 LASER PRODUCTS and comply with the Laser Product Safety Standard EN 60825-1. Repair and maintenance only by authorized Sony technicians. Improper repairs and use can create safety hazards.

**CLASS 1  
LASER PRODUCT  
TO EN 60825-1**

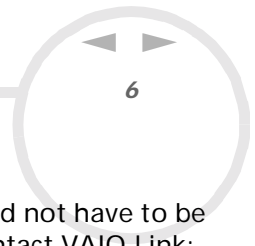

## *Disposing of batteries*

Your Sony VAIO desktop is equipped with an internal back-up memory battery that should not have to be replaced during the lifetime of the product. If you want to replace the battery, please contact VAIO-Link:

<http://www.vaio-link.com>

- Keep away from children.
- Dispose of the battery properly at its end-of-life.
- In some areas the disposal of non-hazardous batteries in household or business waste may be prohibited. Please use the public waste collection system.

## Welcome

Congratulations on purchasing a Sony VAIO desktop. Sony has combined leading-edge technology in audio, video, computing and communications to provide you with state-of-the-art personal computing.

Here are the main features you will be able to enjoy:

- ❑ **Exceptional performance** - Your PC includes a fast processor, an internal modem, and a fast Ethernet interface.
- ❑ **Dual drives** – Enjoy the freedom of two drives; your model has both a CD-RW and a DVD-ROM drive built into the system.
- ❑ **Sony audio and video quality** – The high-quality external stereo speakers enable you to take advantage of today's advanced multimedia applications, games, and entertainment software.
- ❑ **Sony Memory Stick™ media slot** – The next generation in digital storage allows you to easily transfer images, sounds, data and text between cameras, computers, and more.
- ❑ **VAIO keyboard** - Featuring power-on capabilities and shortcut keys to launch your favourite applications within seconds.
- ❑ **Interconnectivity** – Your computer has Ethernet and i.LINK™ functionalities. i.LINK™ is a bi-directional digital interface for exchanging data with compatible devices, such as camcorders.
- ❑ **Windows® XP Home Edition** - Your system includes the latest consumer operating system from Microsoft.
- ❑ **Excellent customer support** - If you are experiencing any problems with your computer, please check the VAIO-Link website for a possible solution:  
<http://www.vaio-link.com>  
Before contacting VAIO-Link either by e-mail or by telephone, please try to solve the problem by reading the User Guide or the manuals and help files for the peripherals or software.



## Documentation pack

Your documentation pack contains printed guides, as well as online user guides preinstalled on your hard drive.

### Printed documentation

The printed part of your documentation pack contains the following:

- ❑ A **Getting Started** brochure, where you will find a brief description of the items in your box, some specifications of your VAIO desktop, and how to set up your computer;
- ❑ A **Customer Guide**, where you will find all the basic information to start using your VAIO desktop, as well as troubleshooting and VAIO-Link information;
- ❑ Your **Sony Guarantee conditions**;
- ❑ A **Safety Regulations Guide** for your information;
- ❑ A **Modem Regulations** flyer applying to the modem.

### Online documentation

The online documentation contains the following guides:

- 1 The **Sony VAIO Desktop User Guide**:
  - ❑ **Using your VAIO desktop** shows you how to use the standard components of your system. In this part of the manual you will also find out what you can do with a Memory Stick™.
  - ❑ **Connecting peripheral devices** explains how you can add functionality by connecting various peripherals.
  - ❑ **Getting help** explains the support options available to you, and offers basic troubleshooting tips.
  - ❑ **Precautions** provides facts and advice about using your VAIO desktop.
  - ❑ **Glossary** refers to terms used in this manual.

## 2 The **Software Guide**:

- ❑ **About the Software** is a short description of the features of the software pre-installed on your system.
- ❑ **Using Video software** explains how to use Sony video software: DVgate, MovieShaker and Smart Capture.
- ❑ **Managing audio files with SonicStage** describes how to convert your existing MP3, WMA and WAV format audio files into ATRAC3 format.
- ❑ **Using DigitalPrint** explains how to get the most enjoyment out of your photographs taken with a digital camera.
- ❑ **Customizing your VAIO computer** explains how to set up your modem and so on.
- ❑ **Installing and updating applications** details how to install, run or uninstall a software application.
- ❑ **Managing drivers** describes how to install, update or uninstall a driver.
- ❑ **Using the Product Recovery CD-ROMs** explains how to perform a system and application recovery.
- ❑ **Using partitioned drives** tells you what you can do with partitioned drives.

3 Refer to the **Specifications** online document for details on your computer, drivers and accessories.

4 In the **VAIO-Link Customer Service Guide** you will find all the VAIO-Link information you need, including specific contact numbers and addresses for each country.

5 Consult the **Online Help** files of the software you are using for detailed information on features and troubleshooting.

6 Refer to the Microsoft **Quick Start** manual for more information on Windows®.

## Your Sony VAIO desktop and its accessories

The following hardware items are in the box\*:

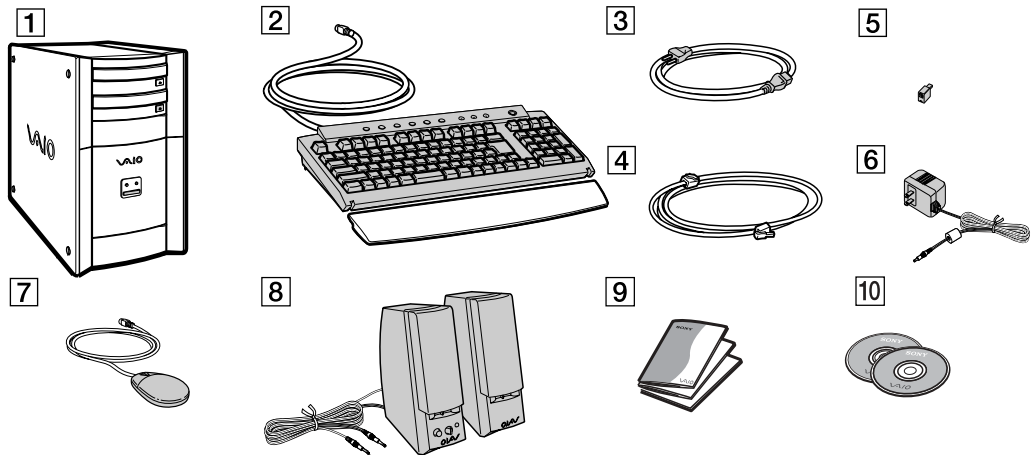

1	main unit	6	AC adapter and power cable for the speakers (country-specific)
2	VAIO keyboard with palmrest	7	VAIO wheel mouse
3	power cable	8	speakers
4	phone cable** (country-specific)	9	documentation pack
5	phone plug adapter** (country-specific)	10	product recovery CD-ROMs

\* See the **Specifications** online document.

\*\*Used to connect the internal modem. Please read the section **Using the correct phone plug (page 30)** before connecting the modem.

### Ergonomic considerations

Whenever possible, try and take into account the following ergonomic considerations when using your new computer, whether at home or in the office:

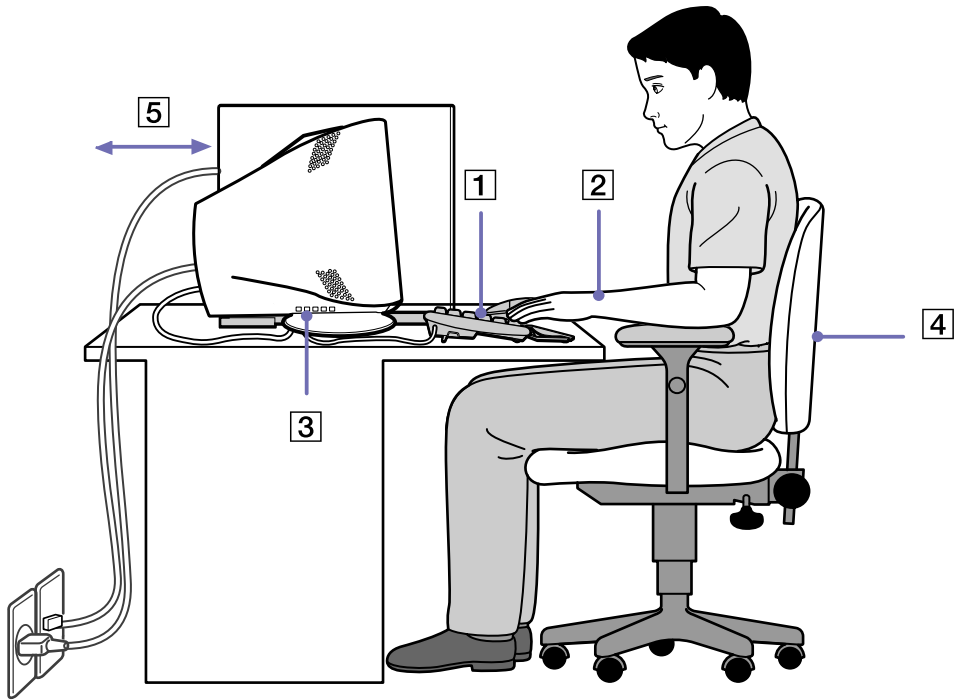

- ❑ **Position of the keyboard and mouse** – Place the keyboard directly in front of you (1). Keep your forearms horizontal, with your wrists in a neutral, comfortable position (2) while using the keyboard or mouse – not at an angle. Let your upper arms hang naturally at your sides. Use the palm rest only briefly, to relax your wrists when you are not typing. Place the mouse at the same level as the keyboard and use your whole arm to move it.
- ❑ **Position and viewing angle of the monitor** – Set the display at a comfortable viewing distance (3). Make sure the display screen is at eye level or slightly lower. Use the display's tilting feature, if available, to find the best position. You can reduce eye-strain and muscle-fatigue by adjusting the tilt of the display to the proper position. Remember to adjust the brightness setting of the display.
- ❑ **Furniture and posture** – Sit in a chair with good back support (4). Adjust the level of the chair so your feet are flat on the floor. A footrest may make you more comfortable. Sit in a relaxed, upright posture and avoid slouching forward or leaning too far backwards.
- ❑ **Lighting** – Choose a location where windows and lights do not create glare or reflection on the display. Use indirect lighting to avoid bright spots reflecting on the display. You can also purchase accessories for your display that help reduce glare. Proper lighting adds to your comfort and work effectiveness.
- ❑ **Ventilation** – Make sure you leave at least 25 cm of space behind and on the left of the main unit (5).
- ❑ **And finally** – Remember to have breaks during sessions with your computer. Excessive use of the computer may strain muscles or tendons.

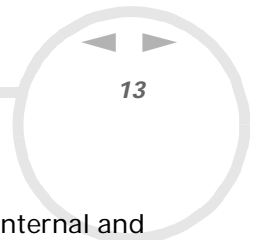

## Using your VAIO desktop

This section describes how to start using your computer and how to use your computer's internal and external devices.

- ❑ Locating controls and connectors ([page 14](#))
- ❑ Starting your computer ([page 16](#))
- ❑ Shutting down your computer ([page 17](#))
- ❑ Using the keyboard ([page 18](#))
- ❑ Using the shortcut keys ([page 23](#))
- ❑ Using the mouse ([page 24](#))
- ❑ Using the CD and DVD drives ([page 25](#))
- ❑ Using the floppy disk drive ([page 27](#))
- ❑ Using the modem ([page 29](#))
- ❑ Expansion capabilities ([page 31](#))
- ❑ Using Memory Stick™ ([page 32](#))
- ❑ Using power saving modes ([page 41](#))

## Locating controls and connectors

### Front panel

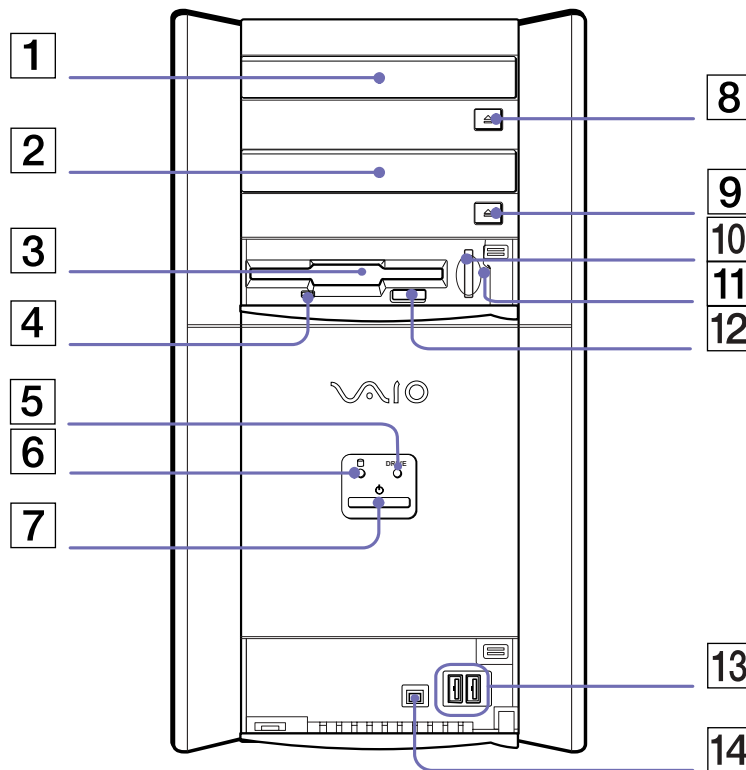

1	DVD-ROM drive	<a href="#">(page 25)</a>
2	CD-RW drive	<a href="#">(page 25)</a>
3	floppy disk drive	<a href="#">(page 27)</a>
4	floppy disk drive indicator	<a href="#">(page 27)</a>
5	disc drive indicator	<a href="#">(page 25)</a>
6	hard disk drive indicator	<a href="#">(page 16)</a>
7	power button and indicator	<a href="#">(page 16)</a>
8	DVD-ROM drive eject button	<a href="#">(page 25)</a>
9	CD-RW eject button	<a href="#">(page 25)</a>
10	Memory Stick™ slot	<a href="#">(page 32)</a>
11	Memory Stick™ indicator	<a href="#">(page 32)</a>
12	floppy disk eject button	<a href="#">(page 27)</a>
13	2 USB ports	<a href="#">(page 47)</a>
14	4-pin i.LINK™ port	<a href="#">(page 49)</a>



## Back panel

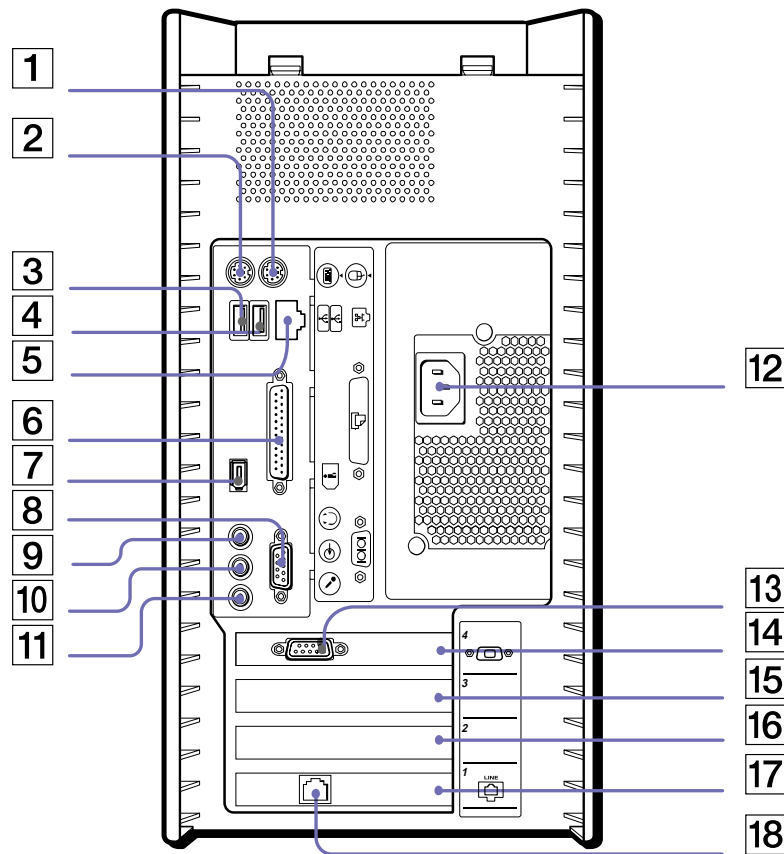

1	mouse connector	<a href="#">(page 24)</a>
2	keyboard connector	<a href="#">(page 18)</a>
3	USB connector	<a href="#">(page 47)</a>
4	USB connector	<a href="#">(page 47)</a>
5	Ethernet connector	<a href="#">(page 52)</a>
6	printer connector	<a href="#">(page 48)</a>
7	i.LINK™ 6-pin connector	<a href="#">(page 49)</a>
8	serial connector	/
9	headphones connector	<a href="#">(page 45)</a>
10	line-in connector	/
11	microphone connector	<a href="#">(page 46)</a>
12	AC input connector	/
13	VGA monitor connector	<a href="#">(page 45)</a>
14	AGP slot	<a href="#">(page 31)</a>
15	PCI slot	<a href="#">(page 31)</a>
16	PCI slot	<a href="#">(page 31)</a>
17	Modem slot	<a href="#">(page 31)</a>
18	telephone line connector	<a href="#">(page 29)</a>

 The mains power cord and connector are hazardous voltage according to EN60950.



## Starting your computer

Once you have all the components set up as described in the **Getting Started** guide, you can begin to use your computer.

To start up your computer, proceed as follows:

- 1 Press the power button on the system unit until the blue power indicator light turns on (1).
- 2 Press the power button on your monitor to turn the display on (2).
- 3 Press the power button on the speakers to turn the sound on (3).

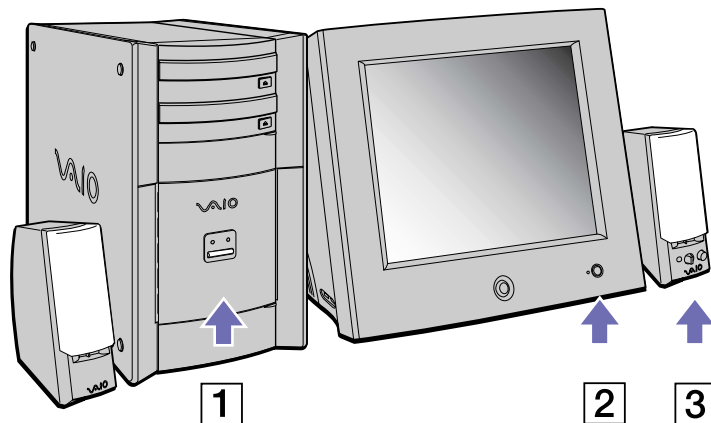

Once you have started using your computer, you can use the shortcut keys on the keyboard to start your system and launch your favourite application automatically.

 If you press the power button for more than four seconds, the computer will switch itself off and you risk losing unsaved data.

## Shutting down your computer

It is important that you shut down your computer properly so you do not lose unsaved data.

To shut down your computer, proceed as follows:

- 1 Click the **Start** button.
- 2 Click **Turn Off Computer**.  
The **Turn off computer** screen appears.
- 3 Click **Turn Off**.  
Wait for your computer to turn off automatically.  
The power indicator turns off.
- 4 Turn off any peripherals connected to your computer.



Respond to any prompts warning you to save documents or to consider other users.

If you are unable to shut down your computer;

- Close all software in use.

- Disconnect any USB devices.

- Press <Ctrl>+<Alt>+<Delete> at the same time. If you have not changed the default setting, you will enter the **Task Manager**. Select **Turn Off** from the **Shut Down** menu to turn the computer off.

Alternatively, press <Alt>+<F4> and select **Turn Off** from the screen that appears.

If this does not work, you can press the power button for more than four seconds. This will shut down the computer. This operation may result in loss of data.

If you are not using the computer for a short period of time, you can save power by using the **Standby** or the **Hibernate** mode. Go to **Start, Turn Off Computer**, and select **Stand By** (see [Using power saving modes \(page 41\)](#) for details).

## Using the keyboard

This section describes the features of the VAIO keyboard.

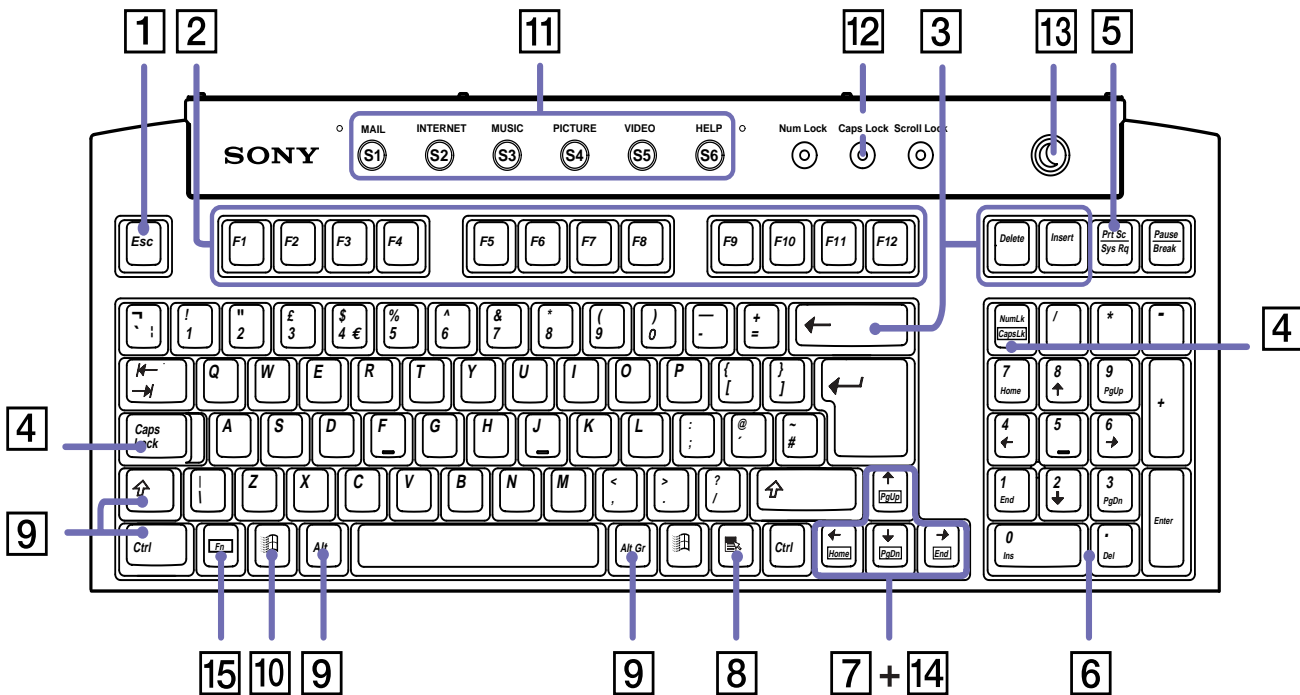

<i>Keys</i>	<i>Descriptions</i>
Escape key (1)	The <Esc> (Escape) key is used to cancel commands.
Function keys (2)	The twelve function keys along the top of the keyboard are used to perform designated tasks. For example, in many applications, <F1> is the <b>Help</b> key. The task associated with each function key may vary from one application to another.
Correction keys (3)	The <Insert>, <Back Space> and <Delete> keys enable you to make corrections when typing.
Lock keys (4)	Press <b>Caps Lock</b> once to activate the uppercase characters. Use the <b>Num Lock</b> key to activate the numerical keypad.
Print Screen key (5)	The <Prt Sc> key takes an electronic snapshot of the screen and moves it to the Windows® Clipboard. You can then paste the screenshot into a document and print it.
Numeric keypad area (6)	This contains the keys found on a typical calculator. Use the numeric keypad area to type numbers or to perform mathematical calculations such as addition and subtraction. Note that you must press the <Num Lock> key to activate the keypad.
Navigation keys (7)	These keys enable you to move the cursor on the screen.
Application key  (8)	The <b>Application</b> key displays a shortcut menu; pressing this key is equivalent to clicking the right mouse button.
Operator keys (9)	Several keys are used in combination with at least one other key: <Ctrl>, <Alt> and <Shift>. When held down at the same time as another key, the <Ctrl> (Control) and <Alt> (Alternate) keys offer another way to execute commands. For example, in many applications, instead of choosing the <b>Save</b> command from a menu, you can hold down <Ctrl> and press <S> (referred to as <Ctrl>+<S>). The <Shift> key is used to type capital letters or special symbols such as @ and \$.

*Keys**Descriptions*

Windows® key  ( 10)	The key with the <b>Windows</b> ® logo displays the <b>Windows</b> ® <b>Start</b> menu; it is equivalent to clicking the <b>Start</b> button on the taskbar.
Shortcut keys (S Keys) (11)	You can use these buttons, numbered 1 to 6, to launch straight into assigned applications.
Indicator LEDs (12)	A green light indicates whether the <b>Caps Lock</b> , <b>Num Lock</b> , and <b>Scroll Lock</b> functions are active.
Standby button (13)	Press this button either to start up your computer, or to enter <b>Standby</b> mode, or to resume from a power saving mode.
<Fn> combination keys (14)	These keys are used in combination with the <Fn> key to execute the commands depicted within the box on the key.
<Fn> key (15)	The <Fn> key is used in combination with 5 other keys to execute certain commands.

## Combinations and functions with the Windows® key

<i>Combinations</i>	<i>Function</i>
⊞ + <F1>	Displays Windows® <b>Help and Support Center</b> .
⊞ + <Tab>	Switches the selected button on the taskbar.
⊞ + <E>	Displays <b>My Computer</b> .
⊞ + <F>	Displays the <b>Search Results</b> window to find a file or folder. This is equivalent to selecting <b>Search</b> from the <b>Start</b> menu.
⊞ + <Ctrl> + <F>	Displays the <b>Search Results - Computers</b> window where you can locate other computers.
⊞ + <M>	Minimizes all displayed windows.
<Shift> + ⊞ + <M>	Returns all minimized windows to their previous size.
⊞ + <R>	Displays the <b>Run</b> window. This is equivalent to selecting <b>Run</b> from the <b>Start</b> menu.

## Combinations and functions with the <Fn> key

Combinations/ Feature	Functions
<Fn> + <b>PgUp</b>	Moves the view to the next page up.
<Fn> + <b>PgDn</b>	Moves the view to the next page down.
<Fn> + <b>Home</b>	Moves the cursor to the beginning of the line.
<Fn> + <b>End</b>	Moves the cursor to the end of the line.
<Fn> + <b>ScrLk</b>	Changes the way in which you can scroll the screen, depending on the application.

## Indicators

Light	On	Off
Num Lock	Turns on when the number keys in the numeric keypad are active.	Turns off when the alphanumeric character keys in the keypad area are active.
Caps Lock	Turns on when the letters appear in uppercase as you type. The <Shift> key lowers the case of typed letters when <b>Caps Lock</b> is on.	Turns off when the letters appear in lowercase as you type (unless you hold down the <Shift> key).
Scroll Lock	Turns on when the screen scrolls differently (not all applications support this function).	Turns off when the information moves across the display normally.

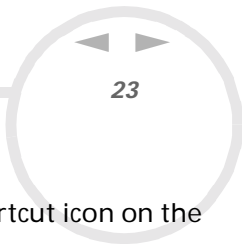

## *Using the shortcut keys*

Press a shortcut key (S Key) to start your favourite software without having to click the shortcut icon on the desktop.

Use an S Key simply by pressing it.

If you want to, you can use VAIO Action Setup to change the functions of the S Keys. All six buttons are reprogrammable.

The programmable S Keys come with the following applications as their default settings:

S1 — Outlook Express

S2 — Internet Explorer

S3 — Sonic Stage

S4 — Digital Print

S5 — DVgate Motion

S6 — Help and Support



## Using the mouse

The VAIO wheel mouse allows you to control the cursor in a number of ways. You can point to, select, drag, and scroll objects on the screen using the buttons and the wheel.

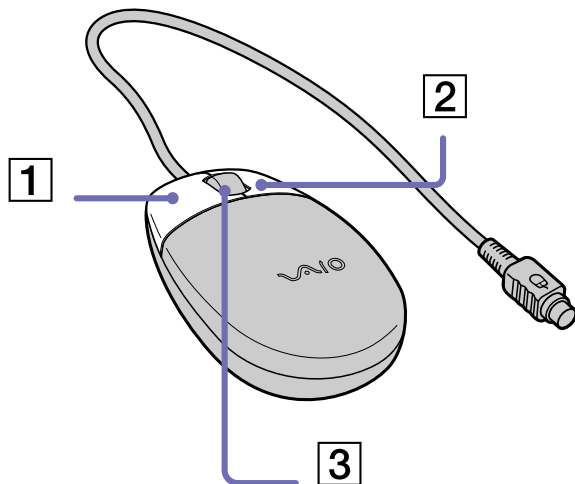

<i>Function</i>	<i>Action</i>
point	Move the entire mouse across a flat surface to place the pointer on an item or object.
click	Press the left button (1) once.
double-click	Press the left button twice.
right-click	Press the right button (2) once. In many applications, this action displays a context-sensitive shortcut menu.
drag and drop	Hold the left button down while sliding the mouse. Then release the button to drop the object.
scroll	Turn the central wheel (3) to scroll up or down a page. Or press the wheel once to lock the scroll action and control the movement by moving the entire mouse. (The scroll function is available only with applications that support a scroll feature.)

 You can set the mouse up for left-hand use. See the **Troubleshooting** (page 56) section for details.

## Using the CD and DVD drives

Your computer is equipped with a CD-RW and a DVD-ROM drive.

- ❑ The DVD-ROM drive (top) reads data from a DVD or CD.
- ❑ The CD-RW drive (bottom) reads data from a CD and writes to a CD-R or CD-RW disc.

Always use the upper drive for the recovery procedures (see the Software Guide). The Recovery CDs will not work in the lower drive.

To insert a disc, proceed as follows:

- 1 Turn on the computer.
- 2 Press the appropriate eject button to open the drive.  
The tray slides out.
- 3 Place a disc in the tray with the label side facing upwards. Make sure the disc is secure in the centre of the tray.
- 4 Close the tray by pushing it gently or by pressing the eject button.

 When the computer is in **Standby** or **Hibernate** mode, you cannot insert or remove a disc.

Be sure to seat the disc firmly in the tray. If you do not seat the disc firmly, you could damage your disc drive and you may not be able to open the tray.

When you have finished using a disc, wait until the LED indicator turns off before pressing the eject button to remove the disc.

If the disc does not come out when you press the eject button, go to **My Computer**. Select the drive, click the right button of your mouse and select **Eject**.

## Writing CDs

Your computer is equipped with a CD-RW drive, on which you can play audio CDs and CD-ROMs, as well as create your own CD-RWs and CD-Rs.

To burn CDs, you can use CD-RW and CD-R discs:

- ❑ The **CD-RW** (ReWritable) disc is a data memory medium that can be used to write, erase and rewrite a program or other data.
- ❑ The **CD-R** (Recordable) disc is a data memory medium that can be used to write a program or other data, but then no more than once.

To achieve optimum performance when writing data on a CD-RW disc, follow these recommendations:

- ❑ To make a CD-R's data readable on another CD-ROM drive, you need to close the session when you eject it. To complete this process, follow the instructions included with your software.
- ❑ Only use circular discs. Do not use discs with any other shape (star, heart, card, etc.), as this may damage the disc drive.
- ❑ Do not strike or shake the computer while writing data to a disc.
- ❑ For optimal writing speed, deactivate the screensaver before writing data to a disc.
- ❑ Memory-resident disc utilities may cause unstable operation or data loss. Deactivate these utilities before writing data to a disc.
- ❑ When using a software application to burn CDs, make sure you exit and close all other applications.
- ❑ Never touch the surface of the disc. Fingerprints and dust on the surface of a disc may cause writing errors.

## Playing DVDs

Your VAIO desktop includes a DVD drive, on which you can play audio CDs, CD-ROMs and DVD-ROMs.

To achieve optimum performance when playing DVD-ROMs, you should follow these recommendations:

- ❑ Close all open applications before playing a DVD-ROM movie.
- ❑ Do not switch power saving modes while playing a DVD-ROM.
- ❑ Do not use resident disc utilities or resident utilities to speed up the access of discs, because they may cause the system to become unstable.
- ❑ Make sure that the screensaver is deactivated.
- ❑ Region codes indicators are labelled on the DVDs to indicate in which region and on what type of player you can play the disc. Unless a **2** or **ALL** is labelled on your DVD or on the packaging, you cannot play the disc on this player.
- ❑ Do not try to change the region code settings of the DVD drive. Any difficulties caused by changing the region code settings of the DVD drive are out of warranty.

## Using the floppy disk drive

Your VAIO desktop is equipped with a floppy disk drive.

### Inserting a floppy disk

To insert a floppy disk, proceed as follows:

- 1 Hold the floppy disk with the label side facing up.
- 2 Gently push the disk into the floppy disk drive until it clicks into place.



### *Removing a floppy disk*

To remove a floppy disk, proceed as follows:

- 1 Wait until the LED indicator turns off.
- 2 Press the eject button to remove the floppy disk.

 Do not press the eject button when the LED indicator is turned on. Otherwise, data may be lost.

## Using the modem

Your VAIO desktop is equipped with an internal modem. You need to connect a phone line to take advantage of online services and the Internet, to register your computer and software online, and to contact VAIO-Link.

To connect a phone line, proceed as follows:

Plug one end of the phone cable (1) into the phone connector on the back of the computer and plug the other end into the wall jack (2).

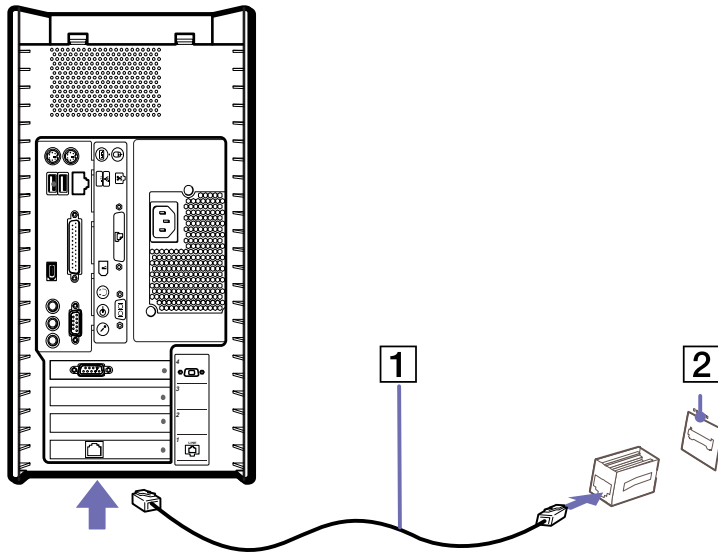

 A country-specific phone plug is supplied with your VAIO desktop, allowing you to plug the phone line into the wall jack. We recommend you to use the supplied plug, because the usage of any other phone plug can decrease the connection quality. See **Using the correct phone plug (page 30)**. Your computer cannot be connected to a coin-operated telephone, and may not work with multiple phone lines or a private branch exchange (PBX). If you connect the modem to a parallel connected phone line, the modem or the other connected device may not function properly. Some of these connections may result in excess electrical current and could cause a malfunction in the internal modem.

Phone cable and connectors are TNV (Telecommunications Network Voltage), according to EN60950.

### Using the correct phone plug

In the box you will find one of the following phone plugs. Make sure you use the correct one for the country you are in, as follows:

**UK:** Use the plug whose connector can be identified by its cuboid shape and flat pins:

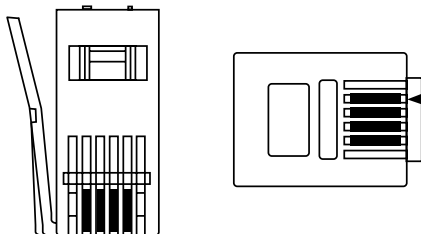

**Netherlands:** Take the plug with the protruding pins:

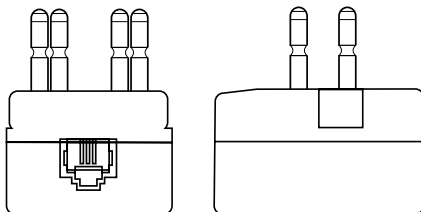

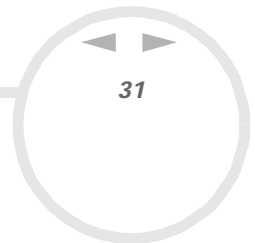

## *Expansion capabilities*

There are four expansion slots at the rear of your VAIO computer:

- PCI Card slot containing the modem card
- AGP slot containing the graphics card
- Empty slot
- Empty slot

The empty slots allow you the choice of adding to the expansion capabilities of your computer. See **Upgrading your VAIO computer (page 70)** for more details.

You are strongly advised not to add hardware yourself. Please contact your local Sony dealer for advice on changing the internal hardware components.



## Using Memory Stick™

Your VAIO computer is designed to support the Memory Stick™. The Memory Stick™ is a compact, portable, and versatile device especially designed for exchanging and sharing digital data with compatible products. Because it is removable, it can be used for external data storage.

Use the flash memory technology to download anything that can be converted into digital data, such as pictures, music, words, sounds, movies and photographs.

Foreseen as the universal data storage device of the future, the Memory Stick™ can already be used with an ever-increasing range of compatible products, including:

- ❑ Audio systems
- ❑ Visual devices
- ❑ VAIO products
- ❑ CLIE handhelds
- ❑ Mobile phones.

There are currently two different types of Memory Stick™:

- ❑ The generic Memory Stick™, coloured blue.
- ❑ The MagicGate Memory Stick™, coloured white.

 You can purchase Memory Sticks™ from the Sony Style website (<http://www.sonystyle-europe.com>), or from your local Sony dealer.

## Why Memory Stick™?

Sony's vision is to expand the world of communication, promoting the portability of digital data. The Memory Stick™ is the resulting medium, through which digital devices can be instantly connected. With it, you can download data from any compatible device, then transfer it to another in a single and instant transfer.

The main advantages of the Memory Stick™ are its:

- ❑ **Compactness:** with dimensions of just 21.5 mm (W) x 2.8 mm (H) x 50 mm (D), compatible products can also be small, lightweight and attractive in their design.
- ❑ **Capacity:** Its data capacity far exceeds that of a floppy disk.
- ❑ **Security:** its lock option means you can protect your data from accidental erasure.
- ❑ **Versatility:** memory capacity ranges from 4 MB up to 128 MB (the equivalent capacity of 88 floppy disks).
- ❑ **Reliability:** by way of protecting the hardware and its contents, the number of terminals is reduced to only 10 pins. This, and the overall robust structure of the stick, gives it a longer lifespan than other storage devices.
- ❑ **Durability:** the same Memory Stick™ can be used tens of thousands of times.
- ❑ **Forward compatibility:** the Memory Stick's™ current format is designed to be compatible with future products and higher capacity Memory Sticks™.

## Generic Memory Stick™

The original Memory Stick™, blue in colour, can be used to record image data taken with digital still cameras, etc. or data from the PC. With it, you can record, play back and transfer various kinds of data at any given time.



Because it is easy to remove and transport safely, you can use Memory Stick™ anywhere by inserting it into any compatible device to transfer and share the information you have saved.

For you, this means you can expand the capabilities of your VAIO computer in the following scenarios:

- ❑ With your still digital camera, share your holiday pictures instantly by e-mail.
- ❑ From your handycam to your VAIO, make the most of your captured moments with the VAIO's movie editing tools.
- ❑ Carry pictures on you by copying image files from the Internet to your VAIO to your CLIE handheld.
- ❑ With your voice recorder, add your voice to e-mails so your tone is never misunderstood.

The blue Memory Stick™ is currently available with a 4, 8, 16, 32, 64 or a 128 MB memory (the equivalent capacity of 88 floppy disks).

 Generic Memory Sticks™ cannot be used with the Memory Stick™ Walkman, or with data that is protected by copyright.

### *MagicGate Memory Stick™*

**As the MagicGate Memory Stick™ is not supported on your RX3 model, the following is for your information only.**

The MagicGate Memory Stick™, white in colour, records PC and image data just like its blue counterpart; the difference is it uses the MagicGate copyright protection technology.



With this type of Memory Stick™, also called the MG Memory Stick™, you can enjoy the following features:

- 32, 64 and 128 MB capacity versions.
- Storage of up to 120 minutes of audio data.
- Download and save:
  - digital music
  - pictures
  - movies, and more.
- Combine data files to add music to your home movies, for example.
- Transfer and share data between several digital products.
- MagicGate Copyright Protection Technology.
- SDMI (Secure Digital Music Initiative) Compliance.
- SonicStage software.

So that you further distinguish a MagicGate Memory Stick™ from a generic one, look for:

- the  logo printed on it

- ❑ a protruding dot located on the back.

 MagicGate is a copyright protection technology that complies with the standards set by SDMI (Secure Digital Music Initiative, an organization working to draw up industry standard specifications in order to protect copyrights of digital music).

The  logo indicates the copyright protection system devised by Sony. It is not meant to guarantee compatibility with other media.

### *MagicGate*

MagicGate refers to the copyright protection technology used by the MagicGate Memory Stick™ and other MagicGate Memory Stick™ compatible devices.

The Memory Stick™ Walkman and MagicGate Memory Stick™ work together to check the data and ensure it complies with copyright protection.

If no problems are detected, the data is exchanged in encrypted form; if authentication is not passed, data cannot be exchanged or played back.

### *SonicStage*

SonicStage uses copyright protection technology designed to manage the digital music content downloaded to the PC from CDs, the Internet and/or other sources.

Software installed on the PC records music content in encrypted form onto the hard disk. As well as allowing you to enjoy music on the PC, this technology protects against unauthorized distribution on the Internet. Since it is compatible with MagicGate, you can use SonicStage to transfer music that you have downloaded onto your PC to your MG Memory Stick™, and playback on other Magic Gate-equipped devices and media.

### *Copyright protection*

People who create artistic works such as music are entitled to a "copyright", meaning that they have exclusive rights to dictate how their work is used. When they are created, artistic works are automatically protected by a copyright without having to submit notification or registration, and may not be used without the permission of the person who created the work.

In the music world, however, illegal acts of distributing music without the permission of the artist,

particularly on the Internet, have recently been on the increase. That is why the Recording Industry Association of America (RIAA) took the initiative to organize a forum called Secure Music Digital Initiative (SDMI) to study technology for protecting copyrights during the electronic distribution of music. Sony offers the MagicGate Memory Stick™ and Memory Stick™ Walkman with a copyright protection function that complies with SDMI standards, thereby providing an environment where individuals can record and enjoy third-party music data without worrying about copyright infringement.

 Literary works that are recorded by individuals are permitted for private usage only.

### *Compatible devices*

There are nearly 80 Memory Stick™-enabled products on the market or announced for introduction worldwide, ranging from camcorders and portable music players to voice recorders and many other electronic devices.

You can currently use Memory Sticks™ with the following Sony products:

#### **Visual:**

- Cybershot digital camera
- Mavica digital camera
- PC, TRV and VX series digital video cameras
- LC data projector

#### **Audio:**

- MS Walkman
- MS Hi-fi system
- Network Walkmans
- Voice recorders

#### **Other:**

- VAIO notebooks
- VAIO desktops

- ❑ CLIE Handheld Entertainment Organiser
- ❑ Sony mobile phones
- ❑ Digital printers
- ❑ AIBO the Sony Entertainment Robot

To find out more about the products available in your country, go to:

<http://www.sonystyle-europe.com>

### *Write-protecting a Memory Stick™*

**Memory Sticks™** are designed with an erasure prevention switch to protect valuable data from accidental erasure or overwriting.

Move the tab to the right or left\* to set or release write-protection. When the erasure prevention switch is off, data can be saved on the Memory Stick™. When the erasure prevention switch is on, data can be read from but not saved on the Memory Stick™.

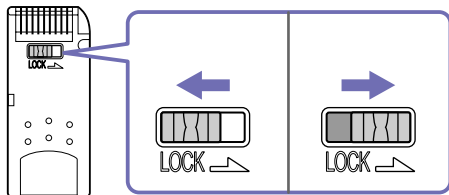

\* The 128 MB Memory Stick™ has a vertical lock.

## Inserting a Memory Stick™

To insert a Memory Stick™, proceed as follows:

Once you have stored your data from your digital device, insert the Memory Stick™ into the Memory Stick™ slot in the front panel.

The Memory Stick™ is automatically detected by your system and appears in the **My Computer** window with its own drive.

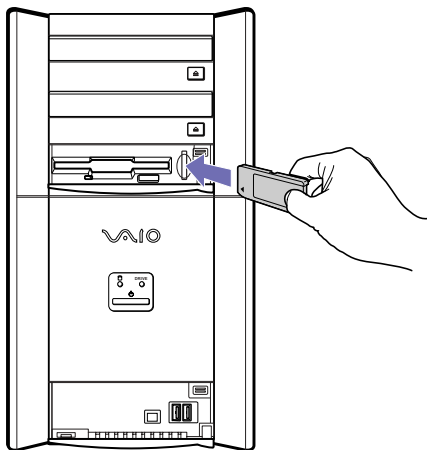

 Always hold the Memory Stick™ with the arrow pointing in the correct direction when you insert it into the slot. To avoid damaging the computer or the Memory Stick™, do not force the Memory Stick™ into the slot if it does not insert smoothly.



### Removing a Memory Stick™

To remove a Memory Stick™, proceed as follows:

Push the Memory Stick™ in to release it, and then pull it out.

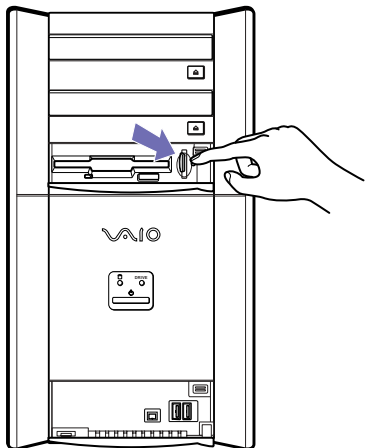

 Always remove the Memory Stick™ gently, or it may pop out unexpectedly.

You are recommended to remove the Memory Stick™ before shutting down the computer.

## Using power saving modes

The colour of the power indicator light on the main unit tells you which mode the computer is in.

<i>Colour</i>	<i>Mode</i>
Blue	Computer is in <b>Normal</b> mode
Umber	Computer is in <b>Standby</b> mode
No colour	Computer is turned off or in <b>Hibernate</b> mode

### Using Standby mode

If you plan to stop using your computer for a short period of time (not overnight), you can put it into **Standby** mode instead of turning it off completely. Putting the computer into **Standby** mode saves energy and allows a quick return to normal computer use.

To set the timer for your computer to automatically enter **Standby** mode after a certain amount of time, go to **Control Panel** and open **Power Options**.

To activate **Standby** mode manually, use one of these two methods:

Use the **Standby** button:

- 1 Save your work, close all applications and close your Internet connection, if applicable.
- 2 Press the **Standby**  button at the top of the keyboard.  
The computer goes into **Standby** mode, indicated by the umber light.

Use the Windows<sup>®</sup> taskbar:

- 1 Save your work, close all applications and close your Internet connection, if applicable.
- 2 From the **Start** menu on the Windows<sup>®</sup> taskbar, select **Turn Off Computer**.  
Alternatively, press <Alt>+<F4> to get to the same dialog box.

### 3 Select **Stand By**.

The computer goes into **Standby** mode, indicated by the amber light.

To return to Normal mode, choose from the following:

- Press any key on the keyboard.
- Press the **Standby** button again.
- Press one of the S Keys on the keyboard.
- Quickly press the power button on your computer.

 You can leave Windows® running when using **Standby**.

If you press the power button for more than four seconds, the computer will switch off automatically.

When the computer is in **Standby** mode, you cannot insert a disc.

**Standby** requires less time than **Hibernate**.

**Standby** uses more power than **Hibernate**.

### *Using Hibernate mode*

If you are interrupted and need to leave your computer suddenly, you can put it into **Hibernate** mode. This power saving mode saves you the time of shutting down in the normal way.

When you put your computer into **Hibernate** mode:

- Everything in the memory is saved to the hard disk.
- The monitor and hard disk are turned off.
- The computer is turned off.
- The power indicator light turns off.

To set the timer for your computer to automatically enter **Hibernate** mode after a certain amount of time, go to **Control Panel** and open **Power Options**.

To activate **Hibernate** mode manually, use one of these two methods:

Use the Windows<sup>®</sup> taskbar:

- 1 Save your work.
- 2 From the **Start** menu on the Windows<sup>®</sup> taskbar, select **Turn Off Computer**.  
Alternatively, press <Alt>+<F4>.
- 3 In the **Turn Off Computer** screen, hold down the <Shift> key to reveal the **Hibernate** button.
- 4 Click **Hibernate**.  
The computer goes into **Hibernate** mode, the computer turns off.

Use the power button:

- Quickly press the power button on the front of the main unit.  
The computer goes into **Hibernate** mode, the computer turns off.

To return to **Normal** mode, quickly press the power button on your computer.  
Operation returns to the same state as before.

 You can leave Windows<sup>®</sup> running when using **Hibernate**.

If you press the power button for more than four seconds, the computer will switch off completely.

When the computer is in **Hibernate** mode, you cannot insert a disc.

**Hibernate** uses less power than **Standby**.

**Hibernate** requires more time than **Standby**.

## Connecting peripheral devices

You can add functionality to your computer by connecting any of these peripherals.

- ❑ Connecting a projector ([page 45](#))
- ❑ Connecting an external microphone ([page 46](#))
- ❑ Connecting a Universal Serial Bus (USB) device ([page 47](#))
- ❑ Connecting a printer ([page 48](#))
- ❑ Connecting an i.LINK™ device ([page 49](#))
- ❑ Connecting to a network ([page 52](#))

Before you connect a peripheral, turn off both the computer and the peripheral.

Connect the power cord only after connecting all cables.

Turn on the computer only after turning on all peripherals.

Please note that the configuration of the front/back panels shown in the following illustrations may vary depending on your model.

 Hot plug and play devices should be plugged when the computer is switched on.

USB devices are hot plug and play devices. You do not need to shut down your computer prior to connecting these devices unless the manual supplied with the device states otherwise.

## Connecting a projector

You can connect a projector (such as the Sony LCD projector) directly to your computer.

To connect a projector to your VAIO desktop, proceed as follows:

- 1 Plug one end of the VGA cable into the VGA monitor connector on the back of your computer, and the other end into the projector you want to use (1).
- 2 Plug the audio cable into the headphones connector identified by the  symbol (2).
- 3 Connect the power cord of the projector into an AC outlet (3).

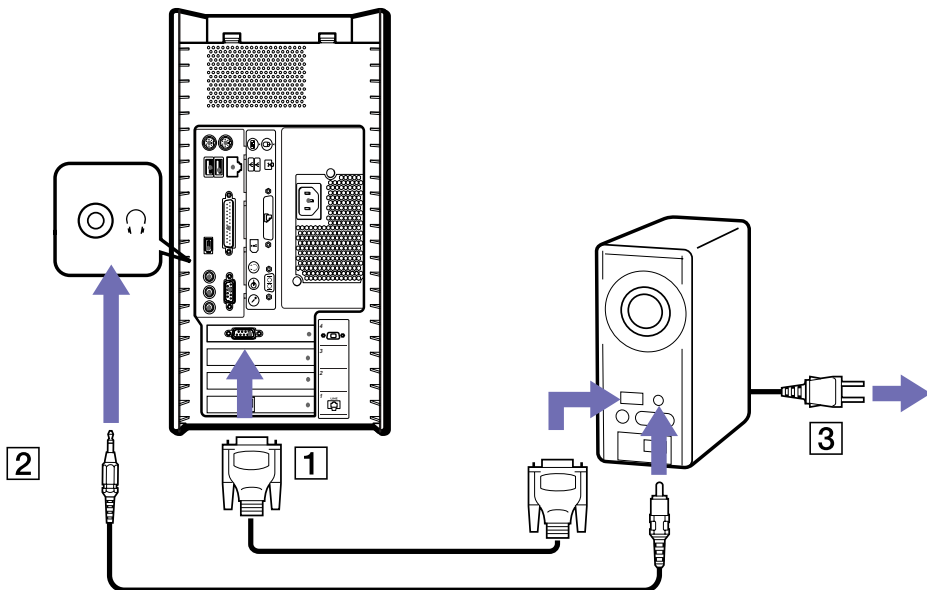

## Connecting an external microphone

Your VAIO desktop does not contain an internal microphone. If you need to use a sound input device, for example to chat on the Internet, you need to plug in an external microphone.

To connect an external microphone, proceed as follows:

Plug the microphone cable (1) into the microphone connector (2) identified by the symbol .

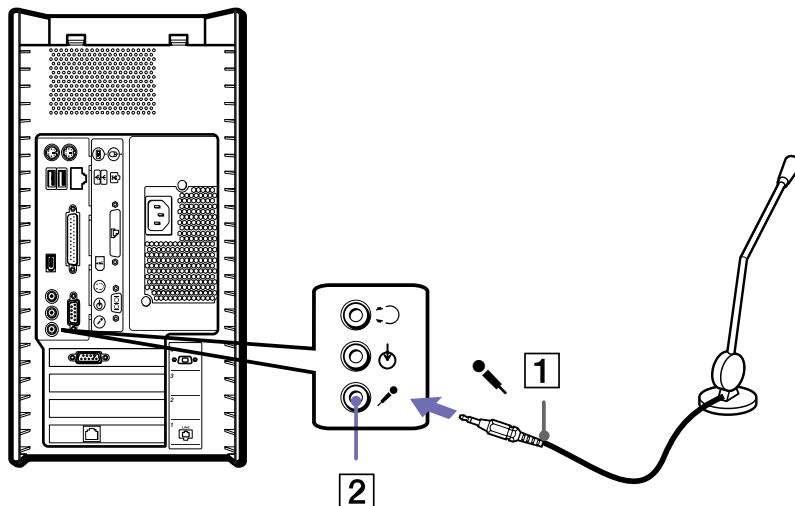

 Make sure your microphone is designed for computer use.

## Connecting a Universal Serial Bus (USB) device

You can connect a USB device, for example, a scanner or a printer, to your VAIO desktop.

There are two USB ports on the front of your VAIO desktop, and two at the back. To connect a USB device, simply plug in the USB cable of the device into one of the ports on your computer.

 For some USB devices you need to install the software before you connect the device. Not following this procedure might cause the device not to work properly. For more information, check the manual provided with the USB device.

You do not need to shut down the computer before connecting or disconnecting a USB peripheral.



## Connecting a printer

To connect a printer, proceed as follows:

- 1 Plug the printer cable into the printer connector on your computer (1).
- 2 Plug the printer power cord into an AC outlet (2).

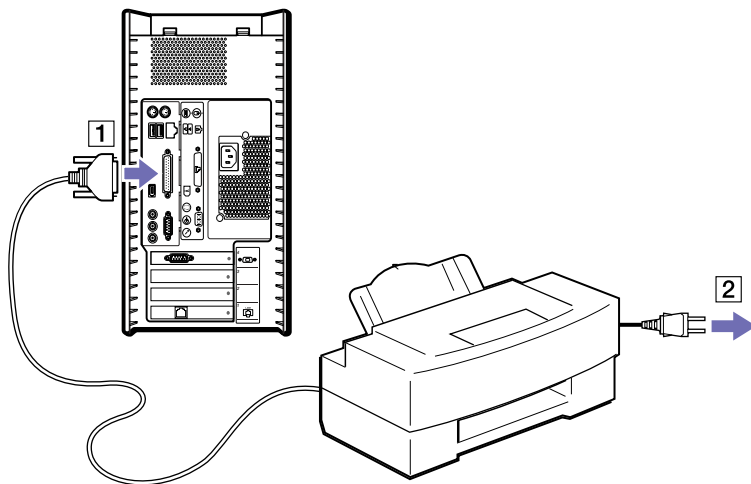

To connect a USB printer, simply plug the printer's USB cable into one of the USB ports on your VAIO desktop. There are two USB ports at the front and two at the back of your computer.

 Do not turn on the computer or the printer until all the connections are made.

These procedures do not apply to all printers. If you do not have a printer compatible to these procedures, please refer to the manufacturer's instructions on connecting and installing it.

## Connecting an i.LINK™ device

Your VAIO computer includes a 4-pin i.LINK™ port on the front of the system and a 6-pin i.LINK™ port on the back of the system. Use these connectors to connect an i.LINK™ device such as a digital video camera recorder or to link up two VAIO computers so you can copy, delete or edit files.

- ❑ The 6-pin i.LINK™ connector on the back of your system can:
  - ❑ Supply power from the computer to the connected device if the device has a 6-pin connector, and
  - ❑ Supply 10V to 12V.
- ❑ The 4-pin i.LINK™ port cannot supply power to a connected device.

The i.LINK™ connectors supports transfer rates up to 400 Mbps; however, the actual transfer rate depends on the transfer rate of the external device.

The i.LINK™ features available may vary depending on the software applications you use. Refer to the documentation that came with your software for more information.

The i.LINK™ cables that are compatible with your VAIO desktop include cables with the following part numbers: VMC-IL4415, VMC-IL4435, VMC-IL4615, VMC-IL4635, VMC-IL6615, and VMC-IL6635. Sony computer supplies, accessories and peripherals can be purchased from your local retailer or from the Sony website:

<http://www.sonystyle-europe.com>

 An i.LINK™ connection with other compatible devices is not fully guaranteed.

You are strongly advised to use only Sony i.LINK™ cables, as using other brands may cause problems with the i.LINK™ devices.

The i.LINK™ connection varies depending on the software applications, operating system and i.LINK™ compatible devices you use. Refer to the documentation that came with your software for more information.

Check the working conditions and OS compatibility of i.LINK™-compatible PC peripherals (HDD, CD-RW drive etc.) before you connect them to your VAIO desktop.

## Connecting a digital video camera recorder

To connect a digital video camera recorder, proceed as follows:

- 1 Plug one end of the i.LINK™ cable (not supplied) into the i.LINK™ connector of the computer and the other end into the DV-Out connector on your digital video camera recorder.

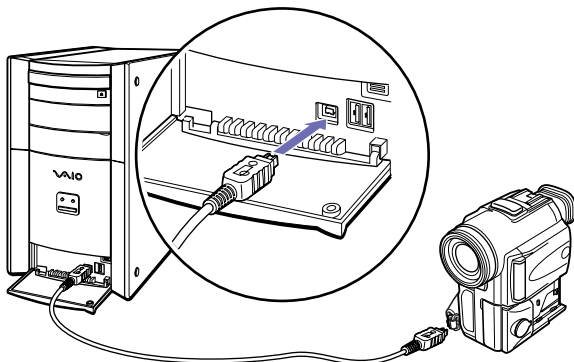

- 2 Launch the DVgate application.

 On Sony digital video cameras, connectors labelled **DV Out**, **DV In/Out** or **i.LINK™** are i.LINK™-compatible.

The Sony digital video camera recorder is an example; your digital video camera recorder may need to be connected differently.

If your digital video camera recorder includes a Memory Stick™ slot, you can copy images from it to your computer via a Memory Stick™. To do so, simply copy images on the Memory Stick™, and then insert it into the Memory Stick™ slot of your computer.

## Connecting two VAIO computers

You can copy, edit or delete files on another VAIO computer to your desktop with an optional i.LINK™ cable. If the second computer has the Windows® XP operating system, you just need the i.LINK™ cable. If the second computer has a different operating system (e.g., Windows® 2000), you need a software application such as Smart Connect.

You can also print a document on a printer connected to another VAIO computer.

To connect your VAIO desktop to another VAIO computer, proceed as follows:

Insert one end of the i.LINK™ cable into one of the i.LINK™ connectors on the main unit of the VAIO desktop and connect the other end to the other VAIO computer.

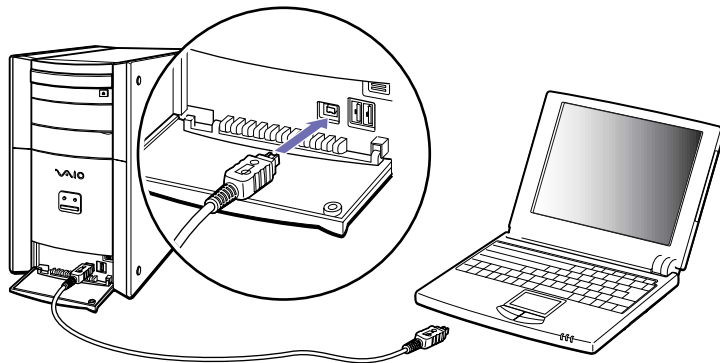

## Connecting to a network

Your computer comes with a preinstalled Ethernet interface.

To connect to a network, proceed as follows:

- 1 Go to **Start**, right-click on **My Computer** and select **Properties**.
- 2 Click the **Hardware** tab and select **Device Manager**.  
The **Device Manager** screen appears with the list of devices.
- 3 Under **Network Adapters**, right click on Realtek RTL 8139 Family PCI Fast Ethernet NIC.
- 4 Click **Properties**.
- 5 Under **Device Usage**, select **Use this device (enable)**.
- 6 Click **OK** to close the **Properties** window.  
The Ethernet connection is now enabled.

! Connect only 10BASE-T/100BASE-TX cables to the Ethernet port. Using other cables or a telephone cable may cause a malfunction, excessive heat or even fire in the port.

 For more information about connecting your VAIO desktop to the network, please consult the Hardware troubleshooting section of the VAIO-Link website:

[How to troubleshoot network problems](#)

For help on connecting to a network, see your network administrator.

## Getting help

This section describes how to get help and support from Sony, as well as troubleshooting tips for your computer.

### *Sony's support options*

Sony provides several support options for your computer.

#### *Printed documentation*

The printed part of your documentation pack contains the following:

- ❑ A **Getting Started** brochure, where you will find a brief description of the items in your box, some specifications of your VAIO desktop, and how to set up your computer;
- ❑ A **Customer Guide**, where you will find all the basic information to start using your VAIO desktop, as well as troubleshooting and VAIO-Link information;
- ❑ Your **Sony Guarantee conditions**;
- ❑ A **Safety Regulations Guide** for your information;
- ❑ A **Modem Regulations** flyer applying to the modem.

#### *Online documentation*

The online documentation contains the following guides:

- 1 The **Sony VAIO Desktop User Guide**:
  - ❑ **Using your VAIO desktop** shows you how to use the standard components of your system. In this part of the manual you will also find out what you can do with a Memory Stick™.

- ❑ **Connecting peripheral devices** explains how you can add functionality by connecting various peripherals.
  - ❑ **Getting help** explains the support options available to you, and offers basic troubleshooting tips.
  - ❑ **Precautions** provides facts and advice about using your VAIO desktop.
  - ❑ **Glossary** refers to terms used in this manual.
- 2 The **Software Guide**:
- ❑ **About the Software** is a short description of the features of the software pre-installed on your system.
  - ❑ **Using Video software** explains how to use Sony video software: DVgate, MovieShaker and Smart Capture.
  - ❑ **Managing audio files with SonicStage** describes how to convert your existing MP3, WMA and WAV format audio files into ATRAC3 format.
  - ❑ **Using DigitalPrint** explains how to get the most enjoyment out of your photographs taken with a digital camera.
  - ❑ **Customizing your VAIO computer** explains how to set up your modem and so on.
  - ❑ **Installing and updating applications** details how to install, run or uninstall a software application.
  - ❑ **Managing drivers** describes how to install, update or uninstall a driver.
  - ❑ **Using the Product Recovery CD-ROMs** explains how to perform a system and application recovery.
  - ❑ **Using partitioned drives** tells you what you can do with partitioned drives.
- 3 Refer to the **Specifications** online document for details on your computer, drivers and accessories.
- 4 In the **VAIO-Link Customer Service Guide** you will find all the VAIO-Link information you need, including specific contact numbers and addresses for each country.
- 5 Consult the **Online Help** files of the software you are using for detailed information on features and troubleshooting.

- 6 Refer to the Microsoft **Quick Start** manual for more information on Windows<sup>®</sup>.

### *Other sources of information*

- ❑ The **online help files** that accompany your pre-installed software contain instructions on using the software.
- ❑ **VAIO-Link website**, which you can access if you have any problems with your computer:  
<http://www.vaio-link.com>
- ❑ **VAIO-Link Response Centre**: Before contacting the VAIO-Link Response Centre, try to solve the problem by reading the user guides and help files supplied with the peripherals or software.



You will need to set up and configure your VAIO's internal modem before you can make use of these communication features.

### *Troubleshooting*

This section describes how to solve common problems you might encounter when using your VAIO desktop. Many problems have simple solutions. Please try these suggestions before contacting VAIO-Link or your local Sony dealer. You are recommended to print out this section and keep it for future reference.

- ❑ About the computer and software ([page 56](#))
- ❑ About the display ([page 61](#))
- ❑ About CDs and floppy disks ([page 62](#))
- ❑ About sound ([page 65](#))
- ❑ About the modem ([page 66](#))
- ❑ About peripherals ([page 67](#))
- ❑ About digital video captures and DVgate ([page 69](#))
- ❑ About i.LINK™ devices ([page 69](#))



## About the computer and software

### *My computer does not start*

- ❑ Check that the computer is plugged into a power source and that it is turned on.
- ❑ Check that the power indicator on the front panel of the computer indicates that the power is on.
- ❑ Confirm that the power cord and all cables are connected firmly.
- ❑ If you have plugged the computer into an Uninterrupted Power Supply (UPS), make sure the UPS is turned on and works.
- ❑ Check that the monitor is properly connected to the main unit. Check that the brightness and contrast controls are adjusted correctly.
- ❑ Moisture condensation may have occurred. Wait at least an hour before turning the computer on.

### *The message 'Press <F1> to continue, <F2> to enter setup' appears at startup*

If the message **Press <F1> to continue, <F2> to enter setup** appears at the bottom of the display, you need to initialize the BIOS.

To initialize the BIOS, proceed as follows:

- 1 Turn off the computer.
- 2 Remove any peripheral devices connected to the computer.
- 3 Turn on the computer and press **<F2>** when the Sony logo appears. The BIOS setup menu screen appears.
- 4 Use the arrow keys to select the **Exit** menu.
- 5 Press **<F9>** or use the arrow keys to select **Get Default Values**. The message **Load default configuration now?** appears.
- 6 Make sure that **Yes** is selected and then press **<Enter>**.

- 7 Press **<F10>** to exit, or use the arrow keys to select **Exit (Save Changes)**. The message **Save configuration changes and exit now?** appears.
- 8 Make sure that **Yes** is selected and then press **<Enter>**.

### *My computer does not shut down*

It is recommended that you shut down your computer using the **Turn Off Computer** command on the Windows® **Start** menu. Using other methods, including those listed here, may result in loss of unsaved data.

If the **Turn Off Computer** command does not work properly, proceed as follows:

- 1 Shut down the computer by pressing **<Alt>+<F4>**. The **Turn off computer** box appears. Select **Turn Off**.
- 2 If this does not work, press **<Ctrl>+<Alt>+<Delete>**. The **Task Manager** dialog box appears. Click **Shut Down**, then **Turn Off**.
- 3 If this does not work, press the power button and hold it for at least four seconds. This turns off the power.
- 4 Unplug the computer from the mains.

### *My system is running slowly*

- ❑ The system response time varies, depending on the number of applications that are open and running. Close any application that you are not currently using.
- ❑ Increasing the system memory may also help. The computer has two memory slots. For memory upgrades, use only PC-2100 DDR SDRAM DIMM modules. For information on installing memory, please see the section **Adding memory (page 73)**.

### *My computer locks up*

- ❑ If you suspect an application is locking your system, you can try to stop it. To do this, press **<Ctrl>+<Alt>+<Delete>** once. If you have not changed the default settings, you will enter the **Task Manager**. On the **Applications** tab, Select the application that is locking your system, and then click **End Task**.
- ❑ If the above method does not work or you do not know which application is locking your system, restart the computer. On the Windows® taskbar, click the **Start** button, click **Turn Off Computer**, and then select **Restart**.  
Alternatively, press **<Alt>+<F4>** to get to the **Turn off computer** screen.
- ❑ If the above method does not work, press the power button and hold it for at least four seconds. This turns off the power.
- ❑ If your computer locks up while playing a CD-ROM or DVD-ROM, stop the CD, and shut down the computer by pressing **<Alt>+<F4>**, and then click **Turn Off**.

### *My computer or software program is not responding*

To end the application that has stopped responding, proceed as follows:

- 1 Press **<Ctrl>+<Alt>+<Delete>**.  
If you have not changed the default settings, you will enter the **Task Manager**.
  - 2 On the **Applications** tab, scroll down until you see the comment **Not responding** next to an application.
  - 3 Select this application from the list and click **End Task**.  
Windows® will try to close the application. If it fails to do so, a second dialog box appears.
  - 4 Select **End Task** again.
-  If you are unable to unlock the application, repeat the above procedure, but select **Shut Down > Turn Off** when the **Windows Task Manager** appears.

If this still fails, proceed as follows:

- 1 If possible, save any unsaved work.
- 2 Press <Alt>+<F4>.  
The **Turn off computer** box appears.
- 3 Select **Restart**.

Make sure the software you are using is compatible with your equipment and operating system. If these options fail, try re-installing the software.

 If none of the above solves the problem, you can turn off the computer by pressing the power button for longer than 4 seconds. All unsaved data will be lost.

If the same application locks up regularly, contact the software publisher or the advertised technical support.

### *Windows® locks up during shutdown*

There are many reasons why the Windows® operating system may not shut down properly, including incompatible or conflicting drivers, damaged files, or non-responsive hardware.

To search Windows® Help for troubleshooting information, proceed as follows:

- 1 From the **Start** menu, select **Help and support**.
- 2 Click **Fixing a problem**.
- 3 Use the browse and search functions to find a solution.

### *My mouse does not work*

Check that the mouse is plugged into the mouse connector on the back of the unit.

There may be dust or dirt inside the mouse mechanism.

To clean the mouse, proceed as follows:

- 1 Turn off the computer and turn the mouse upside down.
- 2 Remove the mouse ball cover by turning the ring clockwise as indicated by the arrows.
- 3 Turn the mouse upright and drop the mouse ball into your hand.
- 4 Using a piece of sticky tape, remove any dirt or dust on the mouse ball and inside the ball socket.
- 5 Put the mouse ball back into the socket and replace the cover.  
Secure the cover by turning the ring anti-clockwise.

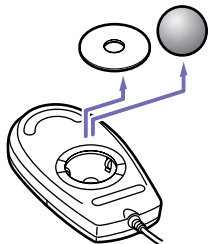

 This cleaning procedure does not apply to optical mouse devices.

### *My mouse needs to be set up for left-hand use*

To set your mouse up for left-handed users, proceed as follows:

- 1 Go to **Start**, select **Control Panel**, then click the **Printers and Other Hardware** option.
- 2 Click the mouse icon.  
The **Mouse Properties** dialog box appears.
- 3 In the **Buttons** tab, select the option button next to **Switch primary and secondary buttons**.
- 4 Click **OK**.  
The new mouse settings are now in place.

## *About the display*

### *My monitor does not display anything*

- Check that the computer is plugged into a power source and that it is turned on.
- Check that the power indicator on the main unit is on.
- Adjust the brightness of the monitor.
- The computer display may be in Standby mode. Press any key to activate the display.

### *The window I have just closed is still on the screen*

Press the **Windows**<sup>®</sup> key and <D> key twice to refresh the screen.

### *I cannot find the Windows<sup>®</sup> taskbar*

- Check that the taskbar is not hidden or minimized.
- Move the cursor to each edge of the screen to retrieve the taskbar.

To change the default view of the taskbar and the **Start** menu, proceed as follows:

- 1 Click **Start**, and select **Control Panel**.
- 2 Click **Appearance and Themes**, then **Taskbar and Start Menu**.  
The **Taskbar and Start Menu Properties** dialog box appears, where you can make the required settings.

### *I want to change the resolution of my display*

To change the resolution of your display, proceed as follows:

- 1 From the **Start** menu, select the **Control Panel**.

- 2 Click **Appearance and Themes**, then the **Display** icon.  
The **Display Properties** dialog box appears.
- 3 Select the **Settings** tab.
- 4 Move the **Screen Resolution** slider to change the resolution.
- 5 Click **OK**.

### *About CDs and floppy disks*

#### *My CD/DVD tray does not open*

To open the disc drive, proceed as follows:

With the eject button:

- 1 Make sure the power is turned on.
- 2 Press the eject button on the appropriate disc drive.

Using **My Computer**:

- 1 Click **Start**, and then **My Computer**.
- 2 Right-click the disc drive icon.
- 3 Select the **Eject** option.  
The disc drive opens and you can retrieve the disc.

If the disc tray still does not eject, the CD/DVD-writing application software may be stopping it. Make sure the application is closed before you proceed.

#### *I cannot play a CD*

- After inserting the CD, wait for a few seconds for the system to detect it before you try to access it.
- Make sure the label of the disc is facing outwards.

- ❑ If the disc requires software, make sure the software is installed according to the instructions of the program.
- ❑ Check the volume of your speakers.
- ❑ Clean the disc with an appropriate cleaner.
- ❑ Moisture condensation may have occurred. Leave the computer for at least 1 hour before turning it on.

### *I cannot play a DVD-ROM*

- ❑ If a region code warning appears when you are using the DVD player, it could be that the DVD-ROM you are trying to play is incompatible with the DVD drive on your VAIO desktop. The region code is listed on the packaging of the disc.
- ❑ If you hear sound but cannot see a picture, your computer's video resolution may be set too high. For best results, change the resolution in the **Control Panel - Display** to a lower resolution.
- ❑ If you see the video but cannot hear sound, check all of the following:
  - ❑ Make sure the mute setting is off in your DVD player software.
  - ❑ Check the master volume setting in the **Volume Control**. If you have connected external speakers, check the volume settings for your computer speakers and check the connections between your speakers and the computer.
  - ❑ In the **Device Manager**, check that the correct drivers are installed properly. To display the **Device Manager**, Go to the **Control Panel**. Click **Performance and Maintenance**, and then the **System** icon. In the **System Properties** dialog box, click on the **Hardware** tab.
- ❑ A dirty or damaged disc may cause the computer to 'hang' while it tries to read the disc. If necessary, reboot the computer, remove the disc and then check that it is not dirty or damaged.

 On your computer, the default DVD region code is 2, which is the region code for European DVDs. Do not change this setting using the Region Code Change function in Windows®, or any other software application. System malfunctions originating from the user changing the DVD region code are beyond the scope of your warranty and will result in service charges for repair.



### *My floppy disk drive cannot write to a disk*

- ❑ The floppy disk may be write-protected. Disable the write-protect feature or use a disk that is not write-protected.
- ❑ Check that the disk is properly inserted into the floppy disk drive.

### *When I double-click an application icon, a message such as 'You must insert the application CD into your drive' appears and the software does not start*

- ❑ Some titles require specific files that are located on the application CD-ROM. Insert the disc and try starting the program again.
- ❑ Make sure you place the disc in the tray with the label side facing outwards.

### *Why does my CD-RW not record at the highest speed?*

For the CD-RW drive, you must use 24x CD-R or 10x CD-RW media to achieve optimum performance.

If you want to use other media and are having difficulty formatting the disc with the above speeds, change the writing speed to a lower setting.

To change the writing speed from the default to a lower speed, proceed as follows:

- 1 Go to **My Computer** from the **Start** menu.
- 2 Right-click the disc drive icon.
- 3 Select **Properties**.
- 4 Select the **Recordings** tab.
- 5 Under **Desktop CD recording**, change the current writing speed to **4x**.
- 6 Click **OK**.  
The speed is changed and recording should run smoothly.

### *The reading speed of CD-RWs is slow*

Generally, the reading speed of a CD-RW is slower than that of a CD-ROM or CD-R. The reading speed can also vary depending on the type of format.

### *About sound*

#### *My speakers are not producing any sound*

- If you are using an application that has its own volume control, check that the volume is turned up.
- Check the volume controls in Windows® and in Windows® Media Player.
- Check that the speakers are connected correctly and the AC adapter is plugged into the mains.

#### *My microphone is too sensitive to background noise*

If you find there is too much background noise when you record sound, you can adjust the microphone gain.

To adjust the microphone settings, proceed as follows:

- 1 In the **Control Panel**, choose **Sounds, Speech and Audio Devices**.
- 2 Click **Sounds and Audio Devices**.  
The **Sounds and Audio Devices Properties** box appears.
- 3 Click the **Voice** tab.
- 4 Under **Voice recording**, click **Volume**.  
The **Recording Control** dialog box appears.
- 5 In the **Options** menu, select **Properties**.  
The **Properties** dialog box appears.
- 6 Change the setting in the **Adjust volume for** dialog box from **Playback** to **Recording**, and then click **OK**.
- 7 Reduce the microphone level by moving the slider control.

- 8 In the Options menu, select **Advanced Controls**, and then click the **Advanced** button under **Microphone - Balance**.  
The **Advanced Controls for Microphone** dialog box appears.
- 9 Deselect the **Microphone Boost** check box, and then click **Close**.
- 10 Close the **Recording Control** dialog box.  
The unwanted noise should now be cleared.

### *About the modem*

#### *My internal modem does not work*

- Check that the phone line is plugged into your computer.
- Check that the phone line is working. You can check the line by plugging in an ordinary phone and listening for a dial tone.
- Check that the phone number the program is dialing, is correct.
- In the **Phone and Modem Options** dialog box (**Control Panel / Printers and other Hardware / Phone and Modem Options**), check that your modem is listed on the **Modems** tab, and that the location information is correct on the **Dialing Rules** tab.
- Whenever you use your modem while travelling, make sure that the country of the active location defined in the **Phone and Modem Options** dialog box matches the country you are dialing from.
- The modem may not work properly if you are behind a **Private Automatic Branch exchange (PABX)**.

#### *My modem cannot establish a connection*

- The modem dialing mode may be incompatible with your telephone line.
- The modem may not work properly if you are behind a **Private Automatic Branch exchange (PABX)**.
- Make sure that the modem is the only device connected to your telephone line.

### *My modem connection is slow*

Many factors influence modem connection speed, including telephone line noise or compatibility with telephone equipment (such as fax machines or other modems). If you think your modem is not connecting properly to other PC-based modems, fax machines, or your Internet Service Provider, check the following:

- Have your phone company check that your phone line is free from any line noise.
- If your problem is fax-related, check that there are no problems with the fax machine you are calling and that it is compatible with fax modems.
- If you are having a problem connecting with your Internet Service Provider, check that the ISP is not experiencing technical problems.
- If you have a second phone line available, try connecting the modem to that line.

### *About peripherals*

*I cannot use DV devices. The message 'DV equipment seems to be disconnected or turned off' appears.*

- Check that the DV device is turned on and that the cables are properly connected.
- If you are using multiple i.LINK™ devices, the combination of the connected devices may cause unstable operation. If this is the case, turn off all connected devices and disconnect unused devices. Check the connection and then turn on the power again.
- You are strongly advised to use only Sony i.LINK™ cables, as using other brands may cause problems with the i.LINK™ devices.

### *How do I install a printer?*

Always check the printer manufacturer's website for the latest drivers for Windows® XP Home Edition before proceeding. Some printers do not function properly without updated drivers. If the printer has a USB connection, the printer should be automatically installed.

To install a local printer, proceed as follows:

- 1 From the **Control Panel**, select **Printers and Other Hardware**, then **Printers and Faxes**.
- 2 Under **Printer Tasks**, click **Add a printer**.
- 3 Let the **Add Printer Wizard** guide you through the installation process.
- 4 Click **Finish**.  
The printer is now installed.

 This procedure applies for most, but not for all printers.

### *I cannot print*

- Check that all the cables of the printer are properly connected.
- Check that your printer is correctly configured and that you have up-to-date drivers. If necessary, contact your dealer.

To reset the printer connection, proceed as follows:

- 1 Click on **Start** and then **Printers and Faxes**.
- 2 Right-click in the left part of the window and select **Refresh**.
- 3 Click on the icon of the printer installed on your computer.
- 4 In the **Printer Tasks** menu, which has now expanded, click on **Set printer properties**.
- 5 Have a look through the different tabs and check that everything seems normal.
- 6 Restart your computer.

### *When I remove a Memory Stick™, an error message appears*

Insert the Memory Stick™ into the slot again and press **<Enter>**. Wait until the active application finishes, then remove the Memory Stick™. If the message confirms the ejection of the Memory Stick™, click **OK**.

### *About digital video captures and DVgate*

*When I record images to a digital video device using DVgate, my system displays the message 'Recording to DV device failed. Check the power and cable connections to the devices and try again'*

Close all open applications and restart your computer. Frequently recording images to a digital video device while using DVgate sometimes causes this error.

### *About i.LINK™ devices*

*My i.LINK™ device does not appear on the desktop*

To see the i.LINK™ device icon on the desktop, proceed as follows:

- 1 Turn off and disconnect your i.LINK™ device.
- 2 Reconnect your device.
- 3 Turn on the power on the device again.  
The icon should now appear on the desktop.

### *The connected i.LINK™ device is not recognised*

Disconnect the i.LINK™ device, then connect it again.

You are strongly advised to use only Sony i.LINK™ cables, as using other brands may cause problems with the i.LINK™ devices.

### *I cannot establish an i.LINK™ connection between two VAIO computers*

- Disconnect then reconnect the i.LINK™ cable.
- If you still have no connection after waiting for a while, restart both computers.
- If either computer has just returned from a power saving mode, the connection may be affected. In this case, make sure you perform a full restart before connecting them.

## Upgrading your VAIO computer

The following procedures assume familiarity with the general terminology associated with PCs and with the regulatory compliance required for modifying electronic equipment.

Observe proper safety precautions at all times.

Your VAIO desktop and memory modules use high precision components and electronic connectors technology. To avoid the invalidation of your guarantee by mishandling, it is recommended that:

You contact your local Sony dealer to install any new internal hardware components.

You do not install memory modules yourself, if you are not familiar with upgrading memory on a computer.

Please contact VAIO-Link if you need assistance.

- ! Always switch the power off before you open the system. Otherwise, damage may occur to the integrated circuits in your computer.
- ! Electrostatic discharge (ESD) can damage disk drives, add-on cards, and other components. Follow the procedures here only at an ESD workstation. Otherwise, do not work on a carpeted area and do not handle materials that produce or hold static electricity, such as cellophane wrappers. Ground yourself by keeping constant contact with an unpanited metal part of the unit while carrying out any of these procedures.

### Opening the side cover

To remove the side panel from the main unit, proceed as follows:

- 1 Shut down your computer and disconnect all peripheral devices.
- 2 Unplug the computer from the mains.
- 3 Wait until the computer cools down.  
The inside of the main unit becomes very hot during operation. Wait for about one hour for the computer to cool down before opening the unit.
- 4 Before you handle the memory module, touch a metal part of the computer to discharge any electricity accumulated on your body.

- 5 Position the main unit so the back panel is facing you.
- 6 Locate the tab on the upper right side of the rear panel, and pull it back until the side cover releases.
- 7 Lift the side cover away from the unit and set it aside.

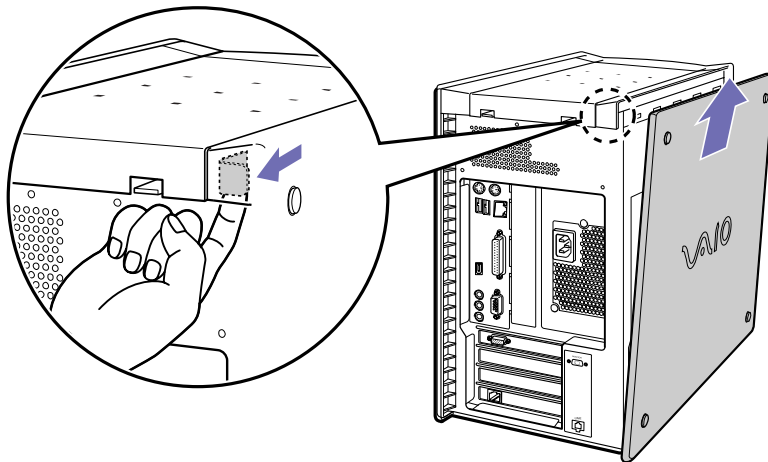

 Always wait for the internal parts of the system unit to cool down before removing the side panel.

### *Inserting a PCI add-on board*

Your computer has open PCI expansion slots. These slots enable you to install add-on boards to expand the functionality of your system.

Add-on board configuration can vary.



To insert an add-on board, proceed as follows:

- 1 Shut down your computer and turn off all peripheral devices, such as your printer.
- 2 Unplug your computer and any peripheral devices.
- 3 Remove the side cover as described in **Opening the side cover (page 70)**.
- 4 Locate one of the two available expansion slots.
- 5 Remove the screw, and then remove the slot cover, as shown:

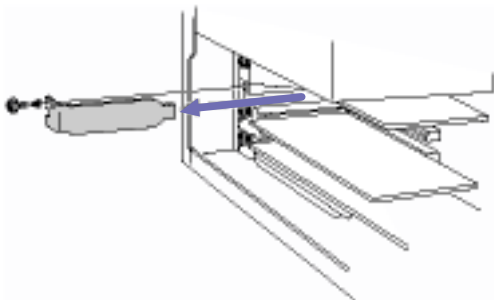

- 6 Install the add-on board by plugging it into the expansion slot and secure it with the screw from the expansion slot, as shown:

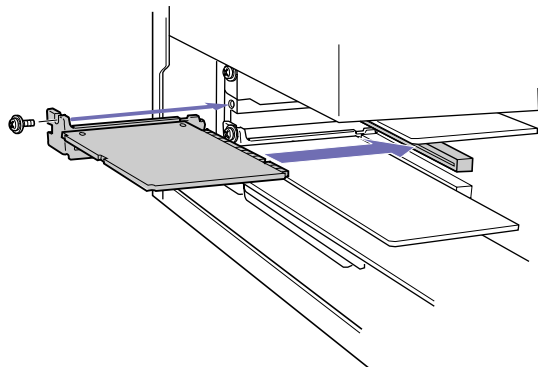

- 7 Attach any internal cables that the board requires (see the manual that came with the add-on board).
- 8 Replace the side cover as described in **Closing the side cover (page 77)**.
- 9 Reconnect all peripheral devices and the power cord, and then turn on the computer.

 Make sure you observe the proper safety precautions when you add boards to your VAIO computer.

## Adding memory

In the future, you may want to install memory modules to expand the functionality of your computer. You can increase the memory by installing optional memory modules, although we recommend that you do not install them yourself unless you are familiar with upgrading memory on a computer.

Be careful when adding memory. Mistakes on installation or removal of the memory module may cause a malfunction.

For memory upgrades, use only PC-2100 DDR SDRAM DIMM.

Electrostatic discharge can damage electronic components. Before touching a memory expansion board, remember the following:

- ❑ Handle the memory module gently.
  - ❑ The procedures described in this document assume familiarity with the general terminology associated with personal computers and with the safety practices and regulatory compliance required for using and modifying electronic equipment.
  - ❑ Disconnect the system from its power source and from any telecommunication links, networks, or modems before you open the system. Failure to do so may result in personal injury or equipment damage.
  - ❑ Electrostatic Discharge (ESD) can damage memory modules and other components. Install the memory module only at an ESD workstation. If such a station is not available, do not work in a carpeted area, and do not handle materials that produce or hold static electricity (cellophane wrappers, for example). Ground yourself by maintaining contact with an unpainted metal portion of the chassis while performing the procedure.
  - ❑ Do not open the memory module package until you are ready to install the module. The package protects the module from ESD.
  - ❑ Use the special bag delivered with the memory module, or wrap the module in aluminium foil to protect it from electrostatic discharge.
-  Do not place the memory module in places subject to:
- Heat sources such as radiators or air ducts,
  - Direct sunlight,
  - Excessive dust,
  - Mechanical vibration or shock,
  - Strong magnets or speakers that are not magnetically shielded,
  - Ambient temperature of more than +35°C or less than +5°C,
  - High humidity.

## Installing a new memory module

If you are not familiar with upgrading memory on a computer, we highly recommend that you contact your dealer.

To add or change a memory module, proceed as follows:

- 1 Shut down the computer, unplug it, and remove any peripheral devices. Wait for the computer to cool down.
- 2 Open the unit (see **Opening the side cover (page 70)**).
- 3 Gently place the unit on its side. If necessary, remove any cables, add-on cards, or other components to access the DIMM slots.  
You must remove the power supply before installing the memory modules. Remove the power supply by following these steps:
  - Remove the screw that secures the power supply to the rear of the chassis.
  - Pull the tab that latches the power supply to the chassis.
  - Slide the power supply up until the power supply clears the chassis.
  - Rotate the power supply to an upside down position and rest it on top of the chassis where the hard drive is located.
- 4 Handle the memory only by the edges, and remove it from its anti-static package.
- 5 Locate the notch on the bottom edge of the memory module (1).
- 6 Align the memory module over the slot, making sure the module is facing the correct way (2).

- 7 Press evenly against the memory module's upper corners. The end latches snap into position automatically, as shown (3):

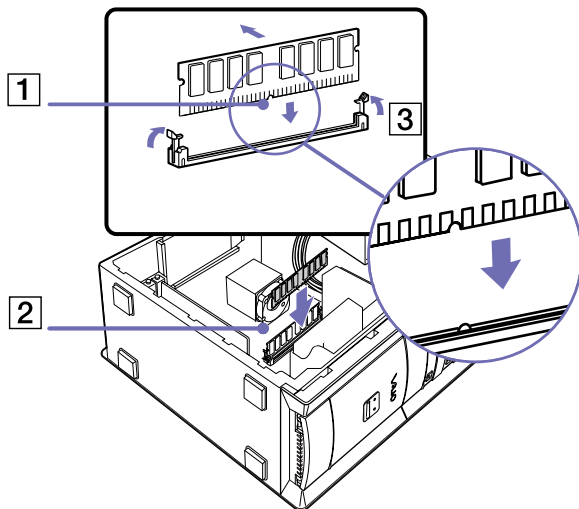

- 8 Reinstall the power supply and any add-on cards or components you removed.
- 9 Reinstall the power supply by following these steps:
- Rotate the power supply to its original position and slide it into the chassis until the tab snaps into position.
  - Replace the screw that secures the power supply to the rear of the chassis.
- 10 Replace the side cover as described in **Closing the side cover**.

 There is only one correct way to insert the memory module. Make sure the rivet of the module is lined up with the connector.

**!** Use only PC-2100 DDR SDRAM DIMM modules.

## Viewing the amount of memory

To view the amount of memory, proceed as follows:

- 1 Turn on the computer.
- 2 Click the **Start** button, point to **All Programs**, then **VAIO System Information**, and click **VAIO System Information** again.  
You can view the amount of installed memory here.

## Closing the side cover

To replace the side cover, proceed as follows:

- 1 Align the tabs on the side cover to the rim of the unit.
- 2 Press the side cover firmly against the unit until it snaps into place.

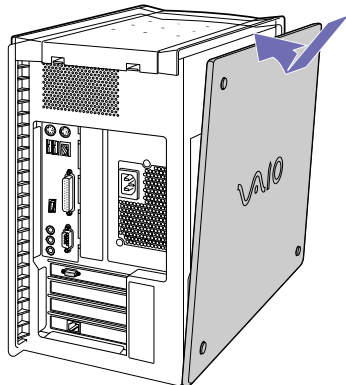

## Precautions

This section describes safety guidelines and precautions to help you protect your computer from potential damage.

Please contact VAIO-Link if you need assistance.

### *On handling the hard disk*

The hard disk has a high storage density and reads or writes data in a short time. However, it can be easily damaged by mechanical vibration, shock or dust.

Although the hard disk has the internal safety device to prevent losing data due to mechanical vibration, shock or dust, you should be careful when handling your computer.

To avoid damaging your hard disk:

- Do not subject your computer to sudden movements.
- Keep the computer away from magnets.
- Do not place your computer in a location subject to mechanical vibration or in an unstable position.
- Do not move your computer while the power is on.
- Do not turn off the power or restart the computer while reading or writing data to disk.
- Do not use your computer in a place subject to extreme changes in temperature.



If the hard disk is damaged, the data cannot be restored.

### *On using the power source*

- Your computer operates on 220-240V AC50/60Hz.
- Do not share the AC outlet with other high power-consuming equipment, such as a photocopier or shredder.

- ❑ You can purchase a power strip with a surge protector. This device prevents damage to your computer caused by sudden power surges, in an electrical storm, for example.
- ❑ Do not place heavy objects on the power cord.
- ❑ To disconnect the cord, pull it out by the plug. Never pull the cord itself.
- ❑ Unplug your computer from the wall outlet if you are planning to not use the computer for a long time.
- ❑ Make sure that the socket outlet is easily accessible

### *On handling your computer*

- ❑ Clean the unit with a soft cloth, which is either dry or lightly moistened with a mild detergent solution. Do not use any type of abrasive pad, scouring powder, or solvent such as alcohol or benzine, as these may damage the finish of your computer.
- ❑ Should you drop a solid object or any liquid onto the computer, shut down your computer and then unplug it. You may want to have the computer checked by qualified personnel before operating it again.
- ❑ Do not drop the computer or place heavy objects on top of the computer.
- ❑ Do not place your computer in a location subject to:
  - ❑ Heat sources, such as radiators or air ducts
  - ❑ Direct sunlight
  - ❑ Excessive dust
  - ❑ Moisture or rain
  - ❑ Mechanical vibration or shock
  - ❑ Strong magnets or speakers that are not magnetically shielded
  - ❑ An ambient temperature of more than 35°C or less than 10°C
  - ❑ High humidity.



- ❑ Do not place electronic equipment near your computer. The electromagnetic field of your computer may cause a malfunction.
- ❑ Provide adequate air circulation to prevent internal heat from building up. Do not place your computer on porous surfaces such as rugs or blankets, or near material such as curtains or draperies that may block its ventilation slots.
- ❑ The computer uses high-frequency radio signals and may cause interference to radio or TV reception. Should this occur, relocate the computer a suitable distance away from the set.
- ❑ Use only specified peripheral equipment and interface cables; otherwise, problems may occur.
- ❑ Do not use cut or damaged connection cables.
- ❑ If the computer is brought directly from a cold location to a warm one, moisture may condense inside your computer. In this case, allow at least one hour before turning on your computer. If any problems occur, unplug your computer and contact VAIO-Link.
- ❑ Make sure you disconnect the power cord before cleaning the computer.
- ❑ As you may lose important data once your computer is damaged, you should back up your data regularly. Restore the original application programs from the Product Recovery CD-ROM.

### *On handling floppy disks*

- ❑ Do not open the shutter manually or touch the surface of the floppy disk.
- ❑ Keep floppy disks away from magnets.
- ❑ Keep floppy disks away from direct sunlight and other sources of heat.

### *On handling compact discs*

- ❑ Do not touch the surface of the disc.
- ❑ Do not drop or bend the disc.

- ❑ Fingerprints and dust on the surface of a disc may cause reading errors. Always hold the disc by its edge and central hole, as shown.
- ❑ Proper care of the disc is essential to its continuous reliability. Do not use solvents such as benzine, thinning agents, commercially available cleaners or anti-static spray, as they may cause damage to the disc.
- ❑ For normal cleaning, hold the disc by its edge and use a soft cloth to wipe the surface from the center out.
- ❑ If the disc is badly soiled, moisten a soft cloth with water, wring it out well, and use it to wipe the surface of the disc from the center out. Wipe off any remaining moisture with a dry soft cloth.

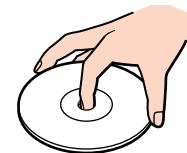

### *On handling Memory Sticks™*

- ❑ Do not touch the Memory Stick™ connector with your finger or metallic objects.
- ❑ Use only the label supplied with the Memory Stick™ as a label.
- ❑ Do not bend, drop, or apply heavy shock to the Memory Stick™.
- ❑ Do not disassemble or modify Memory Sticks™.
- ❑ Do not let Memory Sticks™ get wet.
- ❑ Do not use or store Memory Sticks™ in a location subject to:
  - ❑ Extremely high temperatures, such as in a car parked in the sun
  - ❑ Direct sunlight
  - ❑ High humidity or
  - ❑ Corrosive substances.
- ❑ Use the storage case supplied with the Memory Stick™.

## Glossary

This section refers to terms used in this manual and elsewhere in the VAIO world. These terms and definitions have been compiled to provide you with a better understanding of your VAIO computer.

<i>Term</i>	<i>Definition</i>
<i>&lt;F1&gt; key</i>	The <F1> key gives you access to the online help of most software.
<i>10BASE-T/100BASE-TX</i>	Ethernet system providing data transfer rates of 10 Mbps (megabits per second) and 100 Mbps. The 100BASE-TX is a very direct derivative of 10BASE-T. Its 100 Mbps speed is achieved by simply sending the signal 10 times faster.
<i>ACPI</i>	Short for Advanced Configuration and Power Interface, a power management specification. ACPI enables the operating system to turn peripherals on and off and to control the amount of power given to each device attached to the computer. With ACPI, a CD-ROM player can be turned off by the operating system if it is not in use.
<i>Application recovery</i>	A recovery process that enables you to recover any of the applications initially available on the computer. Performing an application recovery is useful when an individual application does not run properly or to reinstall a driver when a device does not work properly.
<i>Application recovery CD-ROM</i>	CD-ROM that enables a VAIO computer user to recover all the applications that were available when the computer was purchased. The CD-ROM is supplied with the computer.
<i>BIOS</i>	An acronym for Basic Input/Output System. The BIOS is a program that enables the computer to start when you turn it on. It monitors the data stream between the operating system and the computer's hardware devices.
<i>CD-ROM</i>	Abbreviation for Compact Disc Read-Only Memory. A high-capacity optical disc, usually 650 MB in size, capable of being read from but not written to.

<i>Term</i>	<i>Definition</i>
<i>CD-RW</i>	Short for Compact Disc-ReWriteable. Compact Disc that can be used to write or rewrite data to it. A CD-RW can be written to several times, a CD-R can only be written to once.
<i>CPU</i>	The CPU (Central Processing Unit) is the brains of the computer; it processes the instructions of your system's programs. The CPU is also known as the processor or microprocessor and can be found on the motherboard of your computer.
<i>DC In</i>	The Direct Current interface to which you connect your computer's AC adapter.
<i>DDR SDRAM</i>	DDR SDRAM is the new version of SDRAM (Synchronous Dynamic Random Access Memory) with a high-speed data transfer function called double data rate mode.
<i>Driver</i>	A driver is software enabling you to use hardware devices. For example, in order for you to be able to use a printer, you must first install its driver. Many drivers, such as the mouse driver, come with the operating system.
<i>DVD-ROM</i>	Short for Digital Versatile Disc. A type of read-only CD with a minimum capacity of 4.7 GB (maximum capacity can reach 17 GB). This high storage power makes it the ideal medium for storing films.
<i>Ethernet</i>	Ethernet is the most widely implemented local area network (LAN) technology. The Ethernet system called 10BASE-T provides data transfer rates of 10 Mbps (megabits per second). A more recent version of Ethernet, called 100BASE-T, provides data transfer rates of 100 Mbps. Gigabit Ethernet supports data rates of 1 gigabit (1,000 megabits) per second.
<i>EULA</i>	EULA (End-User License Agreement) is the name given to a license governing the software on your computer. The EULA can be found in the <b>Read this first</b> section at the beginning of the software guide or directly on the VAIO desktop.

<i>Term</i>	<i>Definition</i>
<i>i.LINK™</i>	i.LINK™ is Sony's version of the IEEE 1394 standard for high-speed digital serial interface. The standard is regarded in the audio/video and IT industries as the most suitable interface for connecting computers and digital audio/video devices (such as digital cameras etc.).
<i>ISP</i>	An ISP (Internet Service Provider) is a company which provides you with a user name, password and telephone number in order to connect to the Internet.
<i>L2 cache memory</i>	Cache memory is RAM-like memory that enables quick access to data that has already been read by the computer. L1 and L2 are levels of cache memory in a computer.
<i>LAN</i>	A LAN (Local Area Network) is a group of computers connected together within a limited geographical area. It enables users to share devices (such as printers) and information using one processor or server.
<i>LED</i>	Short for Light-Emitting Diode. A semiconductor device that lights up when electricity passes through it.
<i>MAPI</i>	Short for Messaging Application Program Interface. A Microsoft Windows interface enabling you to send e-mail messages. It allows e-mail access and distribution among applications. MAPI-compatible applications include a Send Mail or Send in the File menu of the application.
<i>maximum RAM</i>	The maximum amount of RAM that your computer can contain. Once this amount is reached, you can no longer add additional RAM to your computer.
<i>Motherboard</i>	The motherboard is the main circuit board inside your computer. It holds the CPU, the BIOS, the memory and so on.

<i>Term</i>	<i>Definition</i>
<i>MPEG</i>	MPEG or Moving Pictures Experts Group is a standard for audio-visual compression of video sequences. MPEG achieves high compression rates by storing only the changes from one frame to another. The decrease in data is generally imperceptible to the human eye. MPEG-1 was developed for digital storage of video and audio data on CD-ROM. MPEG-2 achieves better image and audio quality and is more targeted to TV broadcasting and DVD.
<i>Operating system</i>	The operating system is software that manages all the other programs in a computer. It defines how the computer reads and writes information to its disks (and other hardware). Windows 2000, Windows Millennium Edition, Windows XP Professional and Windows XP Home Edition are examples of operating systems found on VAIOs.
<i>Partition</i>	A partition is a logical division of a computer's hard disk. A two-partition hard drive would typically contain C: and D: drives. Partitioning is particularly useful if you run more than one operating system or to clearly separate your data files from your installed software.
<i>PBX</i>	A PBX (Private Branch Exchange) is a private telephone network within an enterprise. Under this system, the calls between the enterprise members are local and the phone numbers are made up of 3 or 4 digits. Companies generally choose this phone system for internal communication because it is less expensive than the regular network. The users can still share a number of outside lines for making calls external to the PBX.
<i>Pixel</i>	A pixel (Picture Element) is a part of your screen. Your screen is made up of thousands of pixels, enabling you to see colours and pictures on it. The more pixels, the higher the resolution and the better the image quality.
<i>Processor</i>	The processor is the brains of the computer; it processes the instructions of your system's programs. The processor is also known as the CPU or microprocessor and can be found on the motherboard (see this word) of your computer.
<i>Product recovery CD-ROM</i>	The product recovery CD-ROMs include the application recovery CD-ROM and the system recovery CD-ROM(s)

<i>Term</i>	<i>Definition</i>
<i>PS/2</i>	A type of mouse or keyboard port.
<i>PSTN</i>	PSTN (Public Switched Telephone Network) refers to the plain old telephone service, the national telecommunication networks implementing voice transmission by using analog signals.
<i>RAM</i>	Short for Random Access Memory, the memory used to run programs and store data in current use. RAM is the fastest kind of memory to read from and write to. Information stored in RAM is lost when you turn off the computer. The higher the RAM capacity, the faster your current data can be processed.
<i>Resolution</i>	The degree of sharpness and clarity of an image. Resolution is expressed in pixels. Frequent computer screen resolutions are 640 x 480 pixels (VGA resolution; appropriate for a 14-inch screen), 800 x 600 (appropriate for a 15-inch screen), 1,024 by 768 (appropriate for a 17-inch screen), and 1,280 by 1,024. LCD displays usually use a higher resolution than a CRT of the same size.
<i>RGB signal cable</i>	RGB stands for Red, Green, Blue. A cable that requires separate transmission types for the three colours on the display.
<i>SDRAM</i>	Synchronous DRAM is a kind of dynamic random access memory running at a much higher clock speed than regular memory.
<i>Standard RAM</i>	The amount of RAM that is available on your computer when you purchase it.
<i>System recovery</i>	A recovery process that enables you to recover the hard disk image initially available on the computer. Performing a system recovery is useful in the event of a serious system crash or if you want to modify the size of your partitions.
<i>System recovery CD-ROM</i>	CD-ROM that is supplied with your computer and that enables a VAIO computer user to recover the hard disk image that was available when the computer was purchased.

<i>Term</i>	<i>Definition</i>
<i>UPS</i>	A UPS (Uninterruptible Power Supply) is a device including a battery that protects your computer from data loss in the event of a power failure. The battery takes over as soon as a power interruption is detected. If you are using the computer when the power failure occurs, you have time to save all unsaved data and to shut down your computer.
<i>USB</i>	USB (Universal Serial Bus) is a hardware interface for attaching devices (such as a keyboard, mouse, joystick, scanner or printer). You can connect up to 127 devices to a USB port. The USB standard is Hot Plug and Play.
<i>VAIO</i>	Short for Video Audio Integrated Operation. Brand name covering Sony's PC products, peripherals, accessories and software. VAIO-branded items are all designed to make the best use of Sony's Audio-Video (AV) and Information Technology (IT) skills.
<i>WAN</i>	WAN (Wide Area Network) is a computer network connected together and covering a relatively large geographical area. This is in contrast to LAN, where the network is usually set up within one building or small geographical area. The largest existing WAN is the Internet.
<i>XGA</i>	Short for Extended Graphic Array, a graphics standard. An XGA board can provide up to 1,024 x 768 pixels and supports up to 65 thousand colours.