

Hardware Guide

PCV-RZ series (PCV-1136)

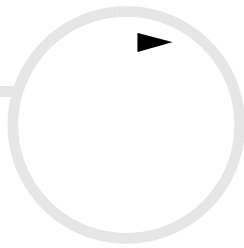

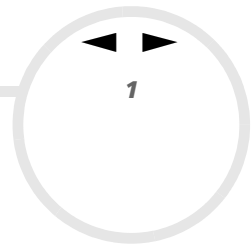

Read this first

Notice

© 2003 Sony Corporation. All rights reserved.

This manual and the software described herein, in whole or in part, may not be reproduced, translated, or reduced to any machine-readable form without prior written approval.

Sony Corporation provides no warranty with regard to this manual, the software, or other information contained herein and hereby expressly disclaims any implied warranties or merchantability or fitness for any particular purpose with regard to this manual, the software or such other information. In no event shall Sony Corporation be liable for any incidental, consequential, or special damages, whether based on tort, contract, or otherwise, arising out of or in connection with this manual, the software, or other information contained herein or the use thereof.

Macrovision: This product incorporates copyright protection technology that is protected by U.S. patents and other intellectual property rights. Use of this copyright protection technology must be authorised by Macrovision, and is intended for home and other limited viewing uses only unless otherwise authorised by Macrovision. Reverse engineering or disassembly is prohibited.

In the manual, the ™ or ® marks are not specified.

Sony Corporation reserves the right to make any modification to this manual or the information contained herein at any time without notice. The software described herein is governed by the terms of a separate user licence agreement.

Please note that the illustrations in this manual may not necessarily apply to your model. Please see the Specifications sheet for the specific configuration of your VAIO.

ENERGY STAR

As an ENERGY STAR Partner, Sony has determined that this product meets the ENERGY STAR guidelines for energy efficiency. The International ENERGY STAR Office Equipment Program is an international program that promotes energy saving through the use of computers and their office equipment. The program backs the development and dissemination of products with functions that effectively reduce energy consumption. It is an open system in which business proprietors can participate voluntarily. The targeted products are office equipment such as computers, displays, printers, facsimiles and copiers. Their standards and logos are uniform among participating nations.

ENERGY STAR is a U.S. registered mark.

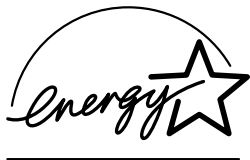

Environmental information



Halogenated flame retardant not used in cabinets.

Cushions formed by corrugated board used in packaging.

Owner's record

The serial number and model number are located on the back of your Sony desktop. Record the numbers and refer to them if you call VAIO-Link. See also the printed **Specifications** document.

Safety information

General

- ❑ Opening the unit, for whatever reason, could lead to damages that are not covered by the guarantee.
- ❑ To avoid electrical shock, do not open the cabinet. Refer servicing to qualified personnel only.
- ❑ To prevent fire or shock hazard, do not expose your VAIO desktop to rain or moisture.
- ❑ If reporting a gas leak, do not use the modem or a telephone in the vicinity of the leak.
- ❑ Avoid using the modem during a severe electrical storm.
- ❑ The power socket outlet you are using must be installed near the equipment and must be easily accessible.
- ❑ Do not move your computer while the system is in **Standby** mode.
- ❑ The magnetic properties of some objects can have serious consequences for your hard disk drive. They can erase the data on the hard disk drive and cause the computer to malfunction. Do not place your computer near or on any objects, which emit magnetic fields, mainly:
 - ❑ TV sets
 - ❑ Speakers
 - ❑ Magnets and magnetic bracelets.

Audio/video

Audio and picture distortion may occur if this equipment is positioned in close proximity to any equipment emitting electromagnetic radiation.

Connectivity

- Never install modem or telephone wiring during a severe lightning storm.
- Never install telephone jacks in wet locations unless the jack is specifically designed for wet locations.
- Take care when installing or modifying telephone lines.
- To disconnect your VAIO desktop completely from the mains voltage, unplug the power cable.
- Make sure that the socket outlet is easily accessible.

Optical disc drive

The use of optical instruments can cause eye hazard. As the laser beam used in this product is harmful to the eyes, do not attempt any disassembling process. For servicing, refer to qualified personnel only.

There is visible and invisible radiation when the optical disc drive is open: avoid direct exposure to the laser beam. The optical disc drives are classified as CLASS 1 LASER PRODUCTS and comply with the Laser Product Safety Standard EN 60825-1. Repair and maintenance only by authorised Sony technicians. Improper repairs and use can create safety hazards.

**CLASS 1
LASER PRODUCT
TO EN 60825-1**

Regulatory information

Sony hereby declares that this product is in compliance with the essential requirements and other relevant provisions of European Directive 1999/5/EC (radio equipment and telecommunications terminal equipment Directive).



Declaration of Conformity

The European Union is targeting the free movement of goods for the internal market and to prevent technical barriers to trade. This effort has resulted in several EU Directives asking that manufacturers make their products comply with essential standards. Manufacturers are required to affix the "CE" mark on the products they sell and to draw up a "Declaration of Conformity" (DoC).

Primarily, the Declarations of Conformity are intended for the market surveillance authorities as proof that products satisfy the required standards. Additionally, Sony provides these EU DoC's on the website <http://www.compliance.sony.de> as a service to our customers.

You can search for all Declarations of Conformity available for a specific product by typing in the model name in the search box. A list of matching documents will be displayed and can be downloaded. Please note that the availability of declarations depends on the scope of the EU Directives and the individual product specifications.

This product complies with EN 55022 Class B and EN 55024 for use in the following areas: residential, commercial, and light industrial.

This product has been tested and found compliant with the limits set out in the EMC Directive for using connection cables not longer than 3 metres (9.8 feet).

Before activating the built-in modem, please read the **Modem Regulations** leaflet.

Disposing of the internal memory backup battery

- ❑ Your Sony VAIO desktop is equipped with an internal back-up memory battery (motherboard battery) that should not have to be replaced during the lifetime of the product. If you want to replace the battery, please contact VAIO-Link: www.vaio-link.com
- ❑ Keep away from children.
- ❑ Dispose of the battery properly at its end-of-life.
- ❑ In some areas the disposal of non-hazardous batteries in household or business waste may be prohibited. Please use the public waste collection system.

Disposing of the AA batteries

Some models are delivered with a remote control.

- ❑ The bundled remote control is powered by AA batteries.
- ❑ For installing the batteries, please refer to the **Giga Pocket** manual in the **VAIO Info Centre**.
- ❑ Do not handle damaged or leaking batteries.
- ❑ Dispose of promptly and properly at end-of-life.
- ❑ May explode or leak if recharged, disposed of in fire, mixed with other types of battery or improperly installed.
- ❑ Keep away from children.
- ❑ In some areas, the disposal of batteries in household or business waste may be prohibited. Please use the public collection system.

Welcome

Congratulations on purchasing a Sony VAIO computer. Sony has combined leading-edge technology in audio, video, computing and communications to provide you with state-of-the-art personal computing.

Here are the main features you can enjoy:

- ❑ **Exceptional performance.**
- ❑ **Dual drives** – Enjoy the freedom of two optical disc drives.
- ❑ **Sony audio and video quality** – The advanced graphics card and high-quality external stereo speakers enable you to take advantage of today's advanced multimedia applications, games, and entertainment software.
- ❑ **Multimedia features** – Enjoy audio and video CDs and DVDs, even record them yourself.
- ❑ **Giga Pocket*** – Take advantage of the new **Giga Pocket** technology, allowing you to watch TV and record your favourite programs digitally and by remote control.
- ❑ **Sony Memory Stick slot** – This compact digital storage medium allows you to easily transfer images, sounds, data and text between cameras, computers, and more.
- ❑ **Interconnectivity** – Your computer has Memory Stick, USB 2.0, i.LINK, CompactFlash and SmartMedia functionalities.
- ❑ **Windows XP** – Your system includes the latest consumer operating system from Microsoft.
- ❑ **Excellent customer support** – If you are experiencing any problems with your computer, please check the VAIO-Link website for a possible solution: www.vaio-link.com. Before contacting VAIO-Link, please try to solve the problem by reading this guide, your printed **Guide to Troubleshooting**, or the manuals and help files for the peripherals or software.

* Not available on all models. See the printed **Specifications** sheet for details.

Documentation pack

Your documentation pack contains printed information and user guides to read on your computer. The user guides are compiled in the **VAIO Info Centre** on the **VAIO Recovery and Documentation Disc** or on a separate disc.

Printed documentation

The printed part of your documentation pack includes the following:

- ❑ A **Getting Started** brochure, where you will find a brief description of the items in your box, and how to set up your computer;
- ❑ A **Specifications** sheet, containing a table of specifications, a list of bundled software and, on the reverse side, a guide to setting up your VAIO;
- ❑ A **Guide to Troubleshooting / Using the VAIO Recovery and Documentation Disc**, where you will find solutions to common problems, an explanation of the purpose and use of the VAIO disc delivered with your computer, and VAIO-Link information;
- ❑ A **Dual Language Operating System** leaflet (not applicable for all countries / models);
- ❑ Your **Sony Guarantee** conditions;
- ❑ A **Safety Regulations** leaflet;
- ❑ A **Modem Regulations** leaflet.

Non-printed documentation

The documentation available either in the **VAIO Info Centre** or on a separate disc includes the following guides:

- ❑ The **Hardware Guide** (this guide).
- ❑ The **Software Guide**, which contains short descriptions of the software features available with VAIO systems.

Depending on your model you may have the following guides:

- ❑ The **Giga Pocket** manual, which explains how to watch and record TV and video on your PC.
- ❑ The **Network Media Receiver** manual, explaining how to display audio, video and photos files, stored on a different computer.

Further sources

- ❑ Consult the **Online Help** files of the software you are using for detailed information on features and troubleshooting.
- ❑ Go to www.club-vaio.com to find online tutorials about your favourite VAIO software.

Ergonomic considerations

Whenever possible, try and take into account the following ergonomic considerations when using your new computer, whether at home or in the office:

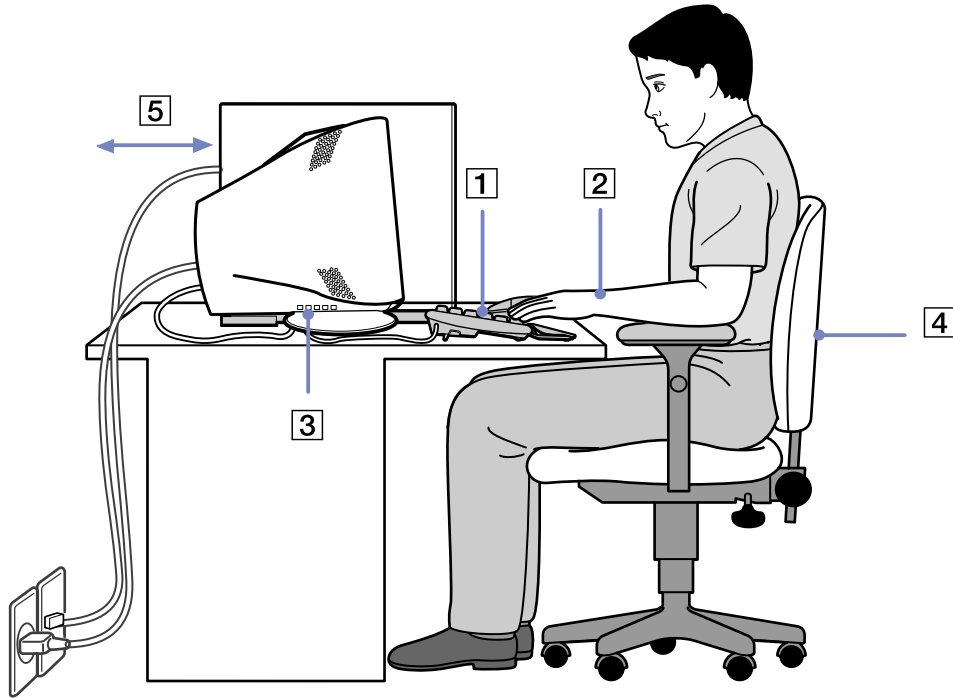

- ❑ **Position of the keyboard and mouse** – Place the keyboard directly in front of you (1). Keep your forearms horizontal, with your wrists in a neutral, comfortable position (2) while using the keyboard or mouse – not at an angle. Let your upper arms hang naturally at your sides. Use the palm rest only briefly, to relax your wrists when you are not typing. Place the mouse at the same level as the keyboard and use your whole arm to move it.
- ❑ **Position and viewing angle of the monitor** – Set the display at a comfortable viewing distance (3). Make sure the display screen is at eye level or slightly lower. Use the display's tilting feature, if available, to find the best position. You can reduce eye-strain and muscle-fatigue by adjusting the tilt of the display to the proper position. Remember to adjust the brightness setting of the display. If you are using a CRT monitor, make sure that the refresh rate is at an optimal level, that is, at least 75Hz.
- ❑ **Furniture and posture** – Sit in a chair with good back support (4). Adjust the level of the chair so your feet are flat on the floor. A footrest may make you more comfortable. Sit in a relaxed, upright posture and avoid slouching forward or leaning too far backwards.
- ❑ **Lighting** – Choose a location where windows and lights do not create glare or reflection on the display. Use indirect lighting to avoid bright spots reflecting on the display. You can also purchase accessories for your display that help reduce glare. Proper lighting adds to your comfort and work effectiveness.
- ❑ **Ventilation** – Make sure you leave at least 25 cm of space behind and on the left of the main unit (5).
- ❑ **And finally** – Remember to have breaks during sessions with your computer. Excessive use of the computer may strain muscles or tendons.

Using your VAIO computer

Once you have read and followed the information in the printed **Getting Started** guide and **Specifications** sheet, you can start using your computer safely and confidently. Read on to get the most out of using your VAIO computer.

- Shutting down your computer safely ([page 13](#))
- Using the keyboard ([page 14](#))
- Using the TV function ([page 15](#))
- Using the mouse ([page 16](#))
- Using the disc drives ([page 18](#))
- Using the floppy disk drive ([page 22](#))
- Using the modem ([page 24](#))
- Using power modes ([page 26](#))
- Using the media slots ([page 29](#))
- Using PC Cards ([page 38](#))
- Expansion capabilities ([page 41](#))

Shutting down your computer safely

It is important that you shut down your computer properly so you do not lose unsaved data.

To shut down your computer, proceed as follows:

- 1 Turn off any peripherals connected to your computer.
- 2 Click the **Start** button.
- 3 Click **Turn Off Computer**.
The **Turn off computer** window appears.
- 4 Click **Turn Off**.
- 5 Respond to any prompts warning you to save documents or to consider other users and wait for your computer to turn off automatically.
The power indicator turns off.



See the printed **Troubleshooting Guide** if you have problems shutting down your computer.

Using the keyboard

Your computer is delivered with a VAIO keyboard. The features are much the same a standard keyboard, plus some additional functions.

For more information on the standard keys, please go to the Windows **Help and Support Center**. The VAIO-Link website (www.vaio-link.com) also contains glossary information to help you use the keyboard.

Indicators

| <i>Light</i> | <i>On</i> | <i>Off</i> |
|--------------|---|---|
| Num Lock | Turns on when the number keys in the numeric keypad are active. | Turns off when the alphanumeric character keys in the keypad area are active. |
| Caps Lock | Turns on when the letters appear in uppercase as you type. The <Shift> key lowers the case of typed letters when Caps Lock is on. | Turns off when the letters appear in lowercase as you type (unless you hold down the <Shift> key). |
| Scroll Lock | Turns on when the screen scrolls differently (not all applications support this function). | Turns off when the information moves across the display normally. |

Using the shortcut keys

Depending on the keyboard delivered with your model, you may be able to use shortcut keys to start your favourite software, without having to click the shortcut icon on the desktop.

Use an <S> Key simply by pressing it.

If you want to, you can use **VAIO Action Setup** to change the functions of the <S> Keys. All the buttons are reprogrammable.

Using the TV function

Depending on your model*, your computer may be equipped with a TV-tuner board. In combination with Sony's **Giga Pocket** software, it allows you to:

- ❑ Watch, record and play back analogue broadcasted cable and terrestrial TV-programs, all by remote control;
- ❑ Digitise analogue video and audio using the S-video or composite and audio inputs;
- ❑ Manage your video units (capsules), preview them and create multiple folders;
- ❑ Set up a timer to record channels at a repeated time;
- ❑ Suspend viewing TV (time-shifting);
- ❑ Stream your recorded TV contents via Ethernet (or WLAN) to connected PCs;
- ❑ Export your video capsules to MPEG2, MPEG1 and (DVI) AVI-files;

 Sony cannot guarantee the streaming of recorded content if it is beyond a certain level of high quality.

For details on using **Giga Pocket** and the remote control, please see the dedicated online guide in the **VAIO Info Centre** or the help files within the software itself.

* See the printed **Specifications** sheet for details.

Using the mouse

Your computer is delivered with a VAIO PS/2 optical mouse, which uses a light-emitting diode (LED) instead of a ball. Avoid using the mouse on a piece of glass or other transparent material, as this can interfere with smooth cursor movement on the screen.

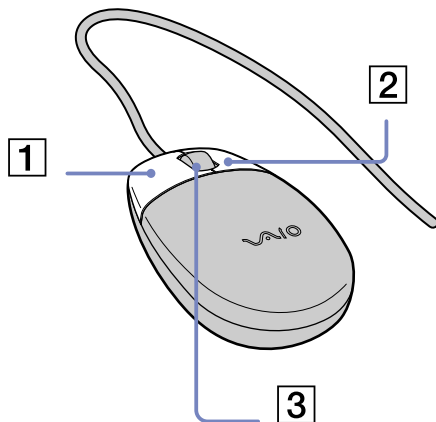

The mouse has the following functions:

| <i>Function</i> | <i>Action</i> |
|-----------------|--|
| point | Move the entire mouse across a flat surface to place the pointer on an item or object. |
| click | Press the left button (1) once. |
| double-click | Press the left button twice. |
| right-click | Press the right button (2) once. In many applications, this action displays a context-sensitive shortcut menu. |
| drag and drop | Hold the left button down while sliding the mouse. Then release the button to drop the object. |
| scroll | Turn the central wheel (3) to scroll up or down a page. Or press the wheel once to lock the scroll action and control the movement by moving the entire mouse (the scroll function is available only with applications that support a scroll feature). |

You can adjust the mouse pointer speed and other functions under **Mouse Properties**. To display **Mouse Properties**, go to the **Control Panel**, select **Printers and Other Hardware**, then select **Mouse**.

Setting up the mouse for left-handed users

To set your mouse up for left-handed users, proceed as follows:

- 1 Go to **Start**, select **Control Panel**, then click the **Printers and Other Hardware** option.
- 2 Click the mouse icon.
The **Mouse Properties** dialog box appears.
- 3 In the **Buttons** tab, select the option button next to **Switch primary and secondary buttons**.
- 4 Click **OK**.
The new mouse settings are now in place.

Using the disc drives

Your computer is equipped with two separate optical drives. Please see the printed **Specifications** sheet to see which drives your model has.

- ❑ A DVD±RW drive reads data from and writes data onto DVD and CD.
- ❑ A DVD-ROM drive reads data from DVDs and CDs.
- ❑ A CD-RW drive reads data from and writes to CDs.
- ❑ A CD-ROM drive reads data from CDs.

To insert a disc, proceed as follows:

- 1 Turn on the computer.
- 2 Press the appropriate eject button to open the drive.
The cover flap opens and the tray slides out.
- 3 Place a disc in the tray with the label side facing upwards.
Make sure the disc is secure in the centre of the tray.
- 4 Close the tray by pushing it gently.

 See the printed **Troubleshooting Guide** if you have problems using discs.

Reading and writing CDs and DVDs

To achieve optimum performance when writing data on to disc (also called 'burning'), follow these recommendations:

- ❑ Only use circular discs. Do not use discs with any other shape (star, heart, card, etc.), as this may damage the disc drive.
- ❑ Do not strike or shake the computer while writing data to a disc.
- ❑ For optimal writing speed, deactivate the screensaver before writing data to a disc.
- ❑ Memory-resident disc utilities may cause unstable operation or data loss. Deactivate these utilities before writing data to a disc.
- ❑ When using a software application to burn discs, make sure you exit and close all other applications.
- ❑ Never touch the surface of the disc. Fingerprints and dust on the surface of a disc may cause writing errors.
- ❑ Never put stickers on discs. This will affect the use of the disc irreparably.

Playing DVDs

To achieve optimum performance when playing DVDs, you should follow these recommendations:

- ❑ Close all open applications before playing a DVD movie.
- ❑ You can play DVDs with the software **PowerDVD for VAIO**.
- ❑ If you want to play a DVD and use **Giga Pocket*** at the same time, please launch **Giga Pocket** before **PowerDVD for VAIO**.
- ❑ Do not switch power saving modes while playing a DVD.
- ❑ Do not use built-in utility applications to speed up the access of discs, because they may cause the system to become unstable.
- ❑ Make sure that the screensaver is deactivated.
- ❑ Region codes indicators are labelled on the DVDs to indicate in which region and on what type of player you can play the disc. Unless a **2** (Europe belongs to region **2**) or **ALL** (this means that you can play this DVD everywhere in the world) is labelled on your DVD disc or on the packaging, you cannot play the disc on this player.
- ❑ Do not try to change the region code settings of the DVD drive. Any difficulties caused by changing the region code settings of the DVD drive are out of warranty.

* Not applicable for all models. Please see the printed **Specifications** sheet for details.

Using two screens while watching a DVD film

By connecting a TV to your computer, you can watch a DVD film while still working on your desktop as normal.

To use the two screens and change the DVD playback settings, proceed as follows:

- 1 Connect your TV to the computer as described in **Connecting a TV (page 45)**.
- 2 Go to **Control Panel**.
- 3 Click **Appearance and Themes** and then **Display**.
The **Display Properties** dialog box appears.
- 4 Click the **Settings** tab.
- 5 Click **Advanced**.

If the ... **NVIDIA GeForce FX...** dialog box appears, proceed as follows:

1. Click **nView Display Mode** on the left.
2. Select the **Clone** check box.
3. Click **Overlay Controls** on the left.
4. Make your required settings here and click **OK** when you have finished.

If the ... **ATI RADEON...** dialog box appears, proceed as follows:

1. Click the **Displays** tab.
2. Select the **TV** button.
3. Click the **Overlay** tab.
4. Make your required settings here and click **OK** when you have finished.

Using the floppy disk drive

Your VAIO desktop is equipped with a floppy disk drive.

Inserting a floppy disk

To insert a floppy disk, proceed as follows:

- 1 Open the cover flap.
- 2 Hold the floppy disk with the label side facing up.
- 3 Gently push the disk into the floppy disk drive until it clicks into place.
- 4 Close the cover flap.

Removing a floppy disk

To remove a floppy disk, proceed as follows:

- 1 Open the cover flap.
- 2 Wait until the LED indicator turns off.
- 3 Press the eject button and pull the disk out gently.
- 4 Close the cover flap.



Do not press the eject button when the LED indicator is turned on. Otherwise, data may be lost.

Troubleshooting floppy disks

My floppy disk drive cannot write to a floppy disk

- The floppy disk is write-protected. Disable the write-protect feature or use a floppy disk that is not write-protected.
- Check that the disk is properly inserted into the floppy disk drive.
- Your disk may be corrupt. Try to insert another floppy disk.

Using the modem

Your VAIO desktop is equipped with an internal modem. As described in the printed **Getting Started** guide, use the single RJ-11 jack to connect the supplied modem cable to the phone line. Once you have connected the phone line and registered with an Internet Service Provider, you can take advantage of online services and the Internet, to register your computer and software online, and to contact VAIO-Link.

Troubleshooting the modem

My modem does not work or cannot establish a connection

- ❑ Check that the phone line is plugged into your computer.
- ❑ Make sure that the modem is the only device connected to your phone line.
- ❑ Check that the phone line is working. You can check the line by plugging in an ordinary phone and listening for a dial tone.
- ❑ Check that the phone number the program is dialling is correct. The modem dialling mode may be incompatible with your telephone line.
- ❑ The modem may not work properly if you are using a Private Automatic Branch eXchange (PABX).
- ❑ In the **Phone and Modem Options** dialog box (**Control Panel / Phone and Modem Options**), check that your modem is listed in the **Modems** tab, and that the location information is correct on the **Dialing Rules** tab.
If you do not see the **Phone and Modem Options** icon, click **Switch to Classic View** on the left side.
- ❑ For users in UK: A country-specific phone plug is supplied with your VAIO computer, allowing you to plug the phone line into the wall jack. We recommend you to use the supplied plug, because the usage of any other phone plug can decrease the connection quality.

- ❑ Your computer cannot be connected to a coin-operated telephone, and may not work with multiple phone lines or a private branch exchange (PBX). If you connect the modem to a parallel connected phone line, the modem or the other connected device may not function properly. Some of these connections may result in excess electrical current and could cause a malfunction in the internal modem.
- ❑ Only DTMF (Dual Tone Multi Frequency) signalling (tone dialling) is supported.
- ❑ Before using the modem, it will be necessary to select the country where you are actually using it. The detailed procedure for selecting your present location is explained in **Configuring your modem** in the **Software Guide**.

My modem connection is slow

Many factors influence modem connection speed, including telephone line noise or compatibility with telephone equipment (such as fax machines or other modems). If you think your modem is not connecting properly to other PC-based modems, fax machines, or your Internet Service Provider, check the following:

- ❑ Have your phone company check that your phone line is free from any line noise.
- ❑ If your problem is fax-related, check that there are no problems with the fax machine you are calling and that it is compatible with fax modems.
- ❑ If you are having a problem connecting with your Internet Service Provider, check that the ISP is not experiencing technical problems.
- ❑ If you have a second phone line available, try connecting the modem to that line.

Using power modes

The colour of the power indicator light on the main unit tells you which mode the computer is in.

| <i>Colour</i> | <i>Mode</i> |
|---------------|--|
| Blue | Computer is in Normal mode |
| Amber | Computer is in Standby mode |
| No colour | Computer is turned off or in Hibernate mode |

 Please see the printed **Specifications** sheet for the exact location of the indicators.

To set the timer for your computer to automatically enter **Standby or Hibernate** mode after a certain amount of time, go to **Control Panel**, click **Performance and Maintenance** and change the settings under **Power Options**.

Using **Standby** mode

If you plan to stop using your computer for a short period of time (not overnight), you can put it into **Standby** mode instead of turning it off completely. Putting the computer into **Standby** mode saves energy and allows a quick return to normal computer use.

To activate **Standby** mode manually, proceed as follows:

- 1 Save your work, close all applications and close your Internet connection, if applicable.
- 2 From the **Start** menu on the Windows taskbar, select **Turn Off Computer**.
Alternatively, press <Alt>+<F4> to get to the same dialog box.
- 3 Select **Stand By**.
The computer goes into **Standby** mode, indicated by the amber light of the power indicator.

To return to **Normal** mode, press any key on the keyboard.



You can leave Windows running when using **Standby**.

When the computer is in **Standby** mode, you cannot insert a disc.

The computer comes out of **Standby** mode quicker than out of **Hibernate** mode and uses more power.

Using **Hibernate** mode

If you are interrupted and need to leave your computer suddenly, you can put it into **Hibernate** mode. This power saving mode saves you the time of shutting down in the normal way.

When you put your computer into **Hibernate** mode:

- ❑ Everything in the memory is saved to the hard disk.
- ❑ The monitor and system are turned off.
- ❑ The computer is turned off.
- ❑ The power indicator light turns off.

To activate **Hibernate** mode manually, use the Windows taskbar:

- 1 Save your work.
- 2 From the **Start** menu on the Windows taskbar, select **Turn Off Computer**.
Alternatively, press <Alt>+<F4> until the **Turn Off Computer** screen is displayed.
- 3 In the **Turn Off Computer** screen, hold down the <Shift> key to reveal the **Hibernate** button.
- 4 Click **Hibernate**.
The computer goes into **Hibernate** mode, the computer turns off.

To return to **Normal** mode, quickly press the power button.

Operation returns to the same state as before.

 You can leave Windows running when using **Hibernate**.

If you press the power button for more than six seconds, the computer will switch off completely.

When the computer is in **Hibernate** mode, you cannot insert a disc.

Hibernate uses less power than **Standby** and requires more time.

Using the media slots

As well as the Sony Memory Stick, your VAIO computer also supports other high capacity memory card formats, such as CompactFlash and SmartMedia. You can exchange digital data with a number of compatible products, such as digital cameras, mobile phones or handheld devices.

Please refer the manual of the individual devices and memory cards.



Some devices may not support the formats that this PC uses as standard. In this case, you may see a message telling you to format the card.

Before you use memory cards other than Memory Sticks in devices such as a digital camera or audio device, you must format them beforehand on the device which you use to record data. Please be aware that formatting the card will delete all the data on it.

The **Sony UMH-U HS-XX USB Device** icon (or similar) is shown in the taskbar when a USB device is in use. However, it also runs Memory Sticks, CompactFlash cards and SmartMedia. It is important that you do not use this icon to disable these memory cards, as it disables all the slots. If you accidentally remove any of the cards via this icon, please restart your computer.

About Memory Sticks

Your VAIO computer is designed to support the Memory Stick. The Memory Stick is a compact, portable, and versatile device especially designed for exchanging and sharing digital data with compatible products, such as digital cameras, mobile phones and CLIÉ handheld devices. Because it is removable, it can be used for external data storage.

Use the flash memory technology to download anything that can be converted into digital data, such as pictures, music, words, sounds, movies and photographs.

The Memory Stick family ranges in capacity and compatibility. To find out more about the Memory Stick features, go to the **VAIO Info Centre**, click on **Welcome > Cool Sony Links** and then **Memory Stick**. This will take you to the dedicated website.

Please see your printed **Specifications** sheet to see which Memory Stick types are compatible with your VAIO and if there are any limitations.

- ❑ You can purchase Memory Sticks from the Sony Style website (www.sonystyle-europe.com), or from your local Sony dealer.
- ❑ Detailed information about which CLIÉ handhelds are compatible with which Memory Sticks can be found here: www.clie-link.com.
- ❑ Detailed information about which VAIO computers are compatible with which Memory Sticks can be found here: www.vaio-link.com.

About SmartMedia

A SmartMedia card (originally called a solid-state floppy disk card) is a memory card that uses flash memory to store data and to make it portable among devices, such as digital cameras, personal digital assistants (PDAs), and other handheld devices.

SmartMedia is similar in size to the CompactFlash card (although significantly thinner), with storage capacities ranging up to 128 MB.

- ❑ This computer supports only SmartMedia with a capacity of 4 MB to 128 MB under a voltage power of 3.3 V.
- ❑ The SmartMedia slot is not for any use other than the writing/reading of memory cards.

Inserting a memory card

To insert a Memory Stick or other memory card, proceed as follows:

- 1 Locate the appropriate memory card slot on the front panel of your VAIO. See the printed **Specifications** sheet for the exact location of the slots.
- 2 Insert the Memory Stick or other card into the slot with the arrow pointing in the correct direction.
- 3 Make sure the card is secure in the slot.
The Memory Stick or card is automatically detected by your system and appears in the **My Computer** window with its own drive.



Always hold memory cards with the arrow pointing in the correct direction when you insert it into the slot. To avoid damaging the computer or the memory card, do not force the card into the slot if it does not insert smoothly.

Removing a memory card

To remove a Memory Stick or other memory card, proceed as follows:

- 1 Make sure the indicator light is not on.
- 2 Push the Memory Stick or card in to release it, and then pull it out.

 You are recommended to remove the memory card before shutting down the computer.

If an error message appears when you remove it, insert the memory card into the slot again and press **<Enter>**. Wait until the active application finishes, then remove the memory card. If the message confirms the ejection of the card, click **OK**.

Please do not remove the memory stick when memory card access lamp is on. Otherwise, the card may not be detected the next time it is inserted into the slot. If the card is removed by mistake and is subsequently not detected, please shut off the power of the computer, wait ten seconds and then turn it on again.

The **Sony UMH-U HS-XX USB Device** icon (or similar) is shown in the taskbar when a USB device is in use. However, it also runs Memory Sticks, CompactFlash cards and SmartMedia. It is important that you do not use this icon to disable these memory cards, as it disables all the slots. If you accidentally remove any of the cards via this icon, please restart your computer.

Write-protecting cards

Memory Sticks and SmartMedia are designed with an erasure prevention switch to protect valuable data from accidental erasure or overwriting.

Move the tab to the right or left to set or release write-protection. (On the 128 MB Memory Stick, move the tab up or down.) When the erasure prevention switch is off, data can be saved on the memory card. When the erasure prevention switch is on, data can be read from but not saved on the memory card.

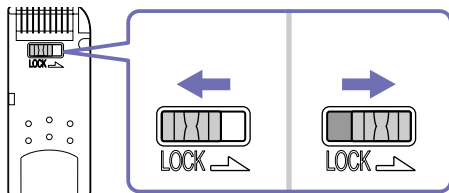

 This image does not apply to the 128 MB Memory Stick, which has a vertical lock. SmartMedia locks may also differ.

Using CompactFlash cards

Your VAIO desktop has a CompactFlash slot that supports Type I or Type II cards. CompactFlash is a removable mass storage device. And is used to interconnect digital cameras, digital music players, desktop computers, handheld PCs, personal communicators, Palm PCs, digital voice recorders and photo printers. Its advanced features include a high transfer rate for fast copy/download and a high storage capacity.

- ❑ This slot cannot be use anything except for writing and reading memory cards or storage device cards.
- ❑ Some CompactFlash cards may require you to disable idle devices during use.
- ❑ You may not be able to use some of the card's features with this computer.
- ❑ Your system may run into serious problems if;
 - ❑ you remove the card or turn the computer off while the card is in use.
 - ❑ your working environment contains high electrical activity.
- ❑ When not is use, always put the CompactFlash card in its case to avoid high electrical effects.

Inserting a CompactFlash card

Simply insert the card gently into the card slot.

The card is automatically detected by your system and will appear with its own icon under **My Computer**.

 Do not force a CompactFlash card into the slot. It may damage the connector pins. If you have difficulty inserting a CompactFlash card, check that you are inserting the card in the correct direction. See the manual supplied with your card for more information on use.

Removing a CompactFlash card

The **Sony UMH-U HS-XX USB Device** icon (or similar) is shown in the taskbar when a USB device is in use. However, it also runs Memory Sticks, CompactFlash cards and SmartMedia. It is important that you do not use this icon to disable these memory cards, as it disables all the slots. If you accidentally remove any of the cards via this icon, please restart your computer.

To remove a CompactFlash card, proceed as follows:

- 1 Make sure the card is not in use and the indicator is not lit.
- 2 Press the release button once so it is extended and ready for use.
- 3 Push the release button again to eject the card.
- 4 Gently grasp the card and pull it out.
The CompactFlash window closes automatically.

 If you remove the CompactFlash card from the computer when it is still in use, your system might crash and unsaved data may be lost. Always back up important data.

Troubleshooting memory cards

- ❑ When you click **Safely remove device** (or a similar icon) in the task bar, the computer can no longer access CompactFlash and SmartMedia cards. Please restart your computer and try again. This also applies to Memory Sticks.
- ❑ Check the write-protect switch on your SmartMedia or Memory Stick. If it is set to on, you cannot write or delete data on the card.

Using PC Cards

Your VAIO desktop has a PC Card slot on the front panel that supports Type I or Type II PC Cards. PC Cards allow you to interconnect with portable external devices.

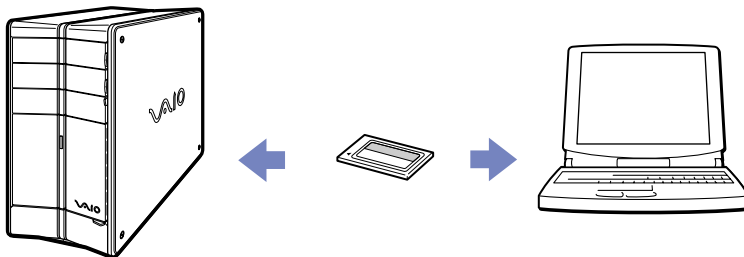

Inserting a PC Card

To insert a PC Card proceed as follows:

- 1 Open the bottom panel on the front of your VAIO.
- 2 Insert the PC Card gently into the PC Card slot with the label facing upwards. The PC Card is automatically detected by your system and the **Safely Remove Hardware** icon  appears in the taskbar.
- 3 Close the cover flap (unless the PC Card peripheral prevents it).

 You do not need to shut down your computer when inserting a PC Card.

Some PC Cards may require you to disable idle devices when using the PC Card.

You may not be able to use some PC Cards or some functions of the PC Card with this computer.

Make sure you use the most recent software driver provided by the PC Card manufacturer.

If the PC Card is operating abnormally, go to **Control Panel, Performance and Maintenance, System**, click the **Hardware** tab, and then **Device Manager**. If an "!" mark appears next to the PC Card device, remove the software driver and then reinstall it from the installation CD that accompanies the PC Card.

Do not force a PC Card into the slot. It may damage the connector pins. If you have difficulty inserting a PC Card, check that you are inserting the PC Card in the correct direction. See the manual supplied with your PC Card for more information on use.

For some PC Cards, if you alternate between **Normal** power operation and **Standby** or **Hibernate** power management modes while the card is inserted, you may find that a device connected to your system is not recognised. Reboot your system to correct the problem.

Removing a PC Card

Follow the steps below to remove the PC Card while your computer is on. If it is not removed properly, your system may crash and unsaved data may be lost. If you want to remove a PC Card when your computer is off, skip steps 1 to 7.

To remove a PC Card, proceed as follows:

- 1 Close any applications that are using the PC Card.
- 2 Double-click the Safely Remove Hardware icon  in the taskbar. The **Safely Remove Hardware** dialog box appears.
- 3 Select the hardware you want to unplug.
- 4 Click **Stop**.
- 5 In the **Stop a Hardware Device** dialog box, select the device and confirm that it can be safely removed from the system.
- 6 Click **OK**.
You see the message that it is safe to remove the device.
- 7 Click **Close**.
- 8 Open the panel cover and press the PC Card release button once so it is extended and ready for use.
- 9 Push the PC Card release button to eject the card.
- 10 Gently grasp the card and pull it out.
- 11 If the PC Card release button is still out, push it back in so you can close the front panel cover.

Expansion capabilities

There are four expansion slots at the rear of your VAIO computer, as follows:

- ❑ **Top slot:** AGP slot containing the graphics card.
- ❑ **Second slot:** Empty PCI slot.
- ❑ **Third slot:** If your model has **Giga Pocket** functions, this is a PCI slot containing the **Giga Pocket** the ports. Otherwise, this is an empty slot.
- ❑ **Bottom slot:** CNR slot containing the modem card.

Empty PCI slots allow you the choice of adding to the expansion capabilities of your computer.

You are strongly advised not to add hardware yourself. Please contact your local Sony dealer for advice on changing the internal hardware components.

Connecting peripheral devices

You can add functionality to your computer by using the various ports on your unit.

To identify and locate the ports on your computer, please see the printed **Specifications** sheet.

- ❑ Connecting a display ([page 43](#))
 - ❑ Connecting a Universal Serial Bus (USB) device ([page 47](#))
 - ❑ Connecting a printer ([page 48](#))
 - ❑ Connecting an i.LINK device ([page 49](#))
 - ❑ Connecting an S/PDIF device ([page 51](#))
 - ❑ Connecting a microphone ([page 51](#))
 - ❑ Connecting to a network ([page 52](#))
-
- ❑ Sony computer supplies, accessories and peripherals can be purchased from your local retailer or from the Sony website: www.sonystyle-europe.com
 - ❑ For more information about connection compatibility, go to the VAIO-Link website: www.vaio-link.com

Connecting a display

You can connect multiple displays to your desktop, each using a different port on the back of your computer:

- ❑ an LCD screen using the DVI connector,
- ❑ a CRT or LCD screen using the VGA connector,
- ❑ a TV using the TV/video out connector.

Please make note of the following viewing possibilities:

- ❑ If you have a VGA and a DVI display connected at the same time, you can switch from one display to the other (the default is VGA), but you cannot display the image on both at the same time.
- ❑ If you have a VGA and a TV connected, the image is shown on both screens by default.
- ❑ If you have a DVI and a TV connected, the image is shown on both screens by default.
- ❑ If you have a VGA, a DVI and a TV connected, the image will be shown either on both the VGA and the TV, or both the DVI and the TV.

To change your display from VGA to DVI or vice versa, proceed as follows:

- 1 Connect the display(s), as described in the printed **Getting Started** or in the instructions delivered with the display, if applicable.
- 2 Go to **Control Panel**.
- 3 Click **Appearance and Themes** then **Display**.
The **Display Properties** dialog box appears.
- 4 Click the **Settings** tab.
- 5 Click **Advanced**.

If the ... **NVIDIA GeForce FX...** dialog box appears, proceed as follows:

1. Click **nView Display Mode** on the left.
2. Select the **Device Settings** button.
3. Click **Select Output Device...** and select the required display.
4. Click **OK**.

If the ... **ATI RADEON ...** dialog box appears, proceed as follows:

1. Click the **Displays** tab.
2. Select the device button you want to use.
3. Click **OK**.

If you reboot after changing the settings as above, the default setting returns and the image is shown on the VGA screen again. If you want the image to be shown on both the DVI and the TV after rebooting, please disconnect the VGA.

Similarly, if you have all three displays connected and want the computer to select DVI and TV when you start your computer, simply make your settings again.

Connecting a TV

You can connect a TV directly to your computer.

In order to be able to use a TV screen, you also have to enable the TV output function.

Your VAIO desktop is delivered with a TV/video out cable (or 'converter cable'), which is for use with TV sets without an S-video port.

Connecting a TV that has no S-video port

To connect a TV to your VAIO desktop with the supplied TV/video out cable, proceed as follows:

- 1 Plug one end of the TV/video out cable into the TV/video out port on the back of your computer.
- 2 Take your composite cable (not supplied) and connect one end to the inserted TV/video out cable.
- 3 Connect the other end to the yellow-coloured port (video-in) on your TV set.
The video output is now in place.
- 4 Connect the single end of your audio cable (not supplied) to the headphones port, either on the back of your computer or on the connected speaker.
- 5 Connect the double end of the audio cable to the red and white ports respectively on your TV set.
The audio output is now in place and your TV is ready for use with your computer.

Connecting a TV that has an S-video port

To connect a TV to your VAIO desktop with an S-video cable (not supplied), proceed as follows:

- 1 Plug one end of the S-video cable into the TV/video out port on the back of your computer.
- 2 Plug the other end of the S-video cable into your TV's S-video port.

To enable TV output, proceed as follows:

- 1 Go to **Control Panel**.
- 2 Click **Appearance and Themes**.
- 3 Click **Display**.
The **Display Properties** dialog box appears.
- 4 Click the **Settings** tab.
- 5 Click **Advanced**.

If the ... **NVIDIA GeForce FX...** dialog box appears, proceed as follows:

1. Click **nView Display Mode** on the left.
2. Select **Clone** and click **Apply**.

If the ... **ATI RADEON...** dialog box appears, proceed as follows:

1. Click the tab **Displays**.
2. Click the **TV** icon.
3. Click **OK**.

Connecting a Universal Serial Bus (USB) device

You can connect a USB device such as a scanner, a floppy disk drive or a printer, to your VAIO desktop.

To connect a USB device, simply plug in the USB cable of the device into one of the ports on your computer. There are USB 2.0 ports on the front and back of your system unit.

- ❑ USB devices are hot plug and play devices. You do not need to shut down your computer prior to connecting these devices unless the manual supplied with the device states otherwise.
- ❑ For some USB devices you need to install the software before you connect the device. Not following this procedure might cause the device not to work properly. For more information, check the manual provided with the USB device.
- ❑ The **Sony UMH-U HS-XX USB Device** icon (or similar) is shown in the taskbar when a USB device is in use. However, it also runs Memory Sticks, CompactFlash cards and SmartMedia. It is important that you do not use this icon to disable these memory cards, as it disables all the slots. If you accidentally remove any of the cards via this icon, please restart your computer.

Connecting a printer

To connect a printer, you can use either the printer port or a USB port, depending on the cable you use for your printer. Please see your printer's documentation for details on connection and installation.

Always check the printer manufacturer's website for the latest drivers for your operating system. Some printers do not function properly without updated drivers.

USB printer drivers should be automatically installed. Once you plug the printer's USB cable into one of the USB ports on your computer, the **Found New Hardware Wizard** will guide you through any setup procedure you need to follow.

If the printer is not automatically installed, you can try the following:

- 1 From the **Control Panel**, select **Printers and Other Hardware**, then **Printers and Faxes**.
- 2 Under **Printer Tasks**, click **Add a printer**.
- 3 Let the **Add Printer Wizard** guide you through the installation process.
- 4 Click **Finish**.
The printer is now installed.



This procedure applies for most, but not for all printers.

Troubleshooting printing

If you have problems printing, check the printed **Troubleshooting Guide**; the documentation delivered with your printer; and the VAIO-Link website (www.vaio-link.com).

Connecting an i.LINK device

Your VAIO computer includes a 4-pin i.LINK port on the front of the system and a 6-pin i.LINK port on the back of the system. Use these ports to connect an i.LINK device such as an optical disc drive or a digital video camera recorder, or to link up two VAIO computers so you can copy, delete or edit files.

- ❑ The i.LINK device will need its own power supply.
- ❑ You are strongly advised to use only Sony i.LINK cables, as using other brands may cause problems with the i.LINK devices.
- ❑ The i.LINK connection may vary, depending on the software applications, operating system, and compatible i.LINK devices. Not all products with an i.LINK connection may communicate with each other.
- ❑ Please refer to the documentation that came with your compatible i.LINK device and software for information on operating conditions and proper connection.

Connecting a digital video camera recorder

To connect a digital video camera recorder, proceed as follows:

- 1 Plug one end of the i.LINK cable (not supplied) into the i.LINK port  of the computer and the other end into the DV out port on your digital video camera recorder.
On Sony digital video cameras, ports marked DV out, DV in/out or i.LINK are i.LINK-compatible.
- 2 Launch the **DVgate** application (see the Help files within the software itself for more information).

 The Sony digital video camera recorder is an example; your digital video camera recorder may need to be connected differently.
If the connected i.LINK device is not recognised, disconnect the i.LINK device, then connect it again.

Troubleshooting i.LINK devices

I cannot establish an i.LINK connection between two VAIO computers

- ❑ You must have administrator rights on your computer to be able to link the two.
- ❑ Disconnect then reconnect the i.LINK cable.
- ❑ If you still have no connection after waiting for a while, restart both computers.
- ❑ If either computer has just returned from a power saving mode, the connection may be affected. In this case, make sure you perform a full restart before connecting them.
- ❑ Check that both units are in the same workgroup, and that the **Sharing** option is enabled.

When I record images to a digital video device using DVgate, I see an error message

- ❑ Close all open applications and restart your computer. Frequently recording images to a digital video device while using **DVgate** sometimes causes this error.
- ❑ Your DV device will need to have DV In/Out in order to be able to transfer your files to the DV device.

I cannot use digital devices

- ❑ Check that the DV device is turned on and that the cables are properly connected.
- ❑ If you are using multiple i.LINK devices, the combination of the connected devices may cause unstable operation. If this is the case, turn off all connected devices and disconnect unused devices. Check the connection and then turn on the power again.
- ❑ You are strongly advised to use only Sony i.LINK cables, as using other brands may cause problems with the i.LINK devices.

Connecting an S/PDIF device

The S/PDIF (Sony/Philips Digital Interface) port on your computer allows you to transfer audio files to optical devices. The advantage is that it does not use the conversion to and from an analog format, which could degrade the signal quality.

Please read the documentation provided with your optical device for connection information.

Connecting a microphone

Your VAIO desktop does not contain an internal microphone. If you need to use a sound input device, for example to chat on the Internet, you need to plug in an external microphone.

To connect an external microphone, plug the microphone cable into the microphone connector identified by the symbol .

 Make sure your microphone is designed for computer use.

Connecting to a network

Your computer comes with a built-in Ethernet interface.

To connect to a network, proceed as follows:

- 1 Connect your 10BASE-T/100BASE-TX Ethernet cable (not supplied) to the Ethernet port, identified by the symbol , on the back of the computer.
If there is a sticker covering the Ethernet port, this is to remind customers in Germany not to insert an ISDN cable (see caution below).
- 2 Go to **Start**, right-click **My Computer** and select **Properties**.
- 3 Click the **Hardware** tab and select **Device Manager**.
The **Device Manager** screen appears with the list of devices.
- 4 Under **Network Adapters**, right-click the name of the adapter.
- 5 Click **Properties**.
- 6 Under **Device Usage**, select **Use this device (enable)**.
- 7 Click **OK** to close the **Properties** window.
The Ethernet connection is now enabled.

! Connect only 10BASE-T/100BASE-TX cables to the Ethernet port. Using other cables or a telephone cable may cause a malfunction, excessive heat or even fire in the port. If using this computer in Germany, please make sure you do not use an ISDN cable. It is physically very similar, but its higher voltage of 12V may destroy the motherboard inside the computer.

 For more information about connecting your VAIO desktop to the network, please consult the hardware troubleshooting section of the VAIO-Link website (www.vaio-link.com):

For help on connecting to a network, see your network administrator if you have one.

Upgrading your VAIO computer

Sony recommends contacting your local dealer for upgrade or maintenance of your new computer. Your local dealer has knowledge of this specialised personal computer and familiar with the safety practices and regulatory compliance required for using and modifying electronic equipment.

The upgrading procedures described in this section assume that you are familiar with the general terminology associated with personal computers and with the safety practices and regulatory compliance required for using and modifying electronic equipment.

Disconnect the computer from its power source and from telecommunication links, networks, or modems before you open the unit or follow any procedures described in this section.

Your computer may not be equipped with all of the hardware features mentioned in this section. The interior configuration of your system may vary from the illustrations, depending on the computer purchased.

To view the hardware configuration for your computer, see the printed **Specifications** sheet.

Your VAIO desktop and memory modules use high precision components and electronic connector technology. To avoid the invalidation of your guarantee by mishandling, it is recommended that:

- You contact your local Sony dealer to install any new internal hardware components.
- You do not install memory modules yourself, if you are not familiar with upgrading memory on a computer.
- Please contact VAIO-Link if you need assistance.

! Failure to disconnect your computer from its power source may result in personal injury or equipment damage.

! Electrostatic discharge (ESD) can damage disk drives, add-on cards, and other components. Follow the procedures here only at an ESD workstation. Otherwise, do not work on a carpeted area and do not handle materials that produce or hold static electricity, such as cellophane wrappers. Ground yourself by keeping constant contact with an unpainted metal part of the unit while carrying out any of these procedures.

Opening the side cover

To remove the side panel from the main unit, proceed as follows:

- 1 Shut down your computer and disconnect all peripheral devices.
- 2 Unplug the computer from the mains.
- 3 Wait until the computer cools down.
- 4 The inside of the main unit becomes very hot during operation. Wait for about one hour for the computer to cool down before opening the unit.
- 5 With the main unit's back panel facing you, position the main unit on its left side.
- 6 Locate the tabs on the side cover, and pull them up until the cover releases.

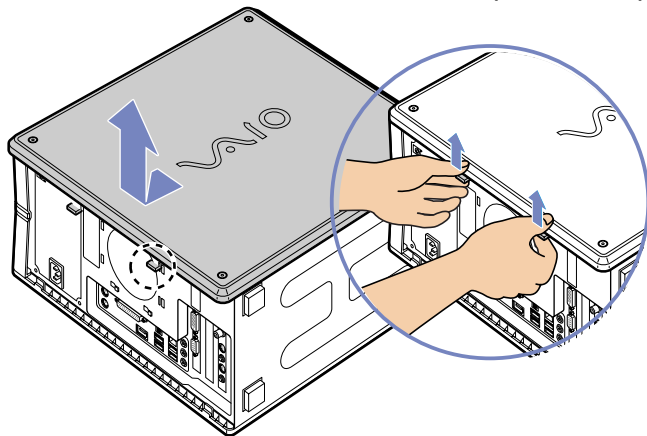

- 7 Slide the cover away from the unit and set it aside.

Upgrading memory

In the future, you may want to upgrade the memory installed on your VAIO by replacing / adding memory modules. However, we recommend that you do not install them yourself unless you are familiar with upgrading memory on a computer.

For memory upgrades, use only those modules mentioned in the printed **Specifications** table.

Be careful when adding memory yourself. Mistakes on installation or removal of the memory module may cause a malfunction.

Electrostatic discharge can damage electronic components. Before touching a memory expansion board, remember the following:

- ❑ Handle the memory module gently.
 - ❑ The procedures described in this document assume familiarity with the general terminology associated with personal computers and with the safety practices and regulatory compliance required for using and modifying electronic equipment.
 - ❑ Disconnect the system from its power source and from any telecommunication links, networks, or modems before you open the system. Failure to do so may result in personal injury or equipment damage.
 - ❑ Do not open the memory module package until you are ready to install the module. The package protects the module from ESD.
 - ❑ Use the special bag delivered with the memory module, or wrap the module in aluminium foil to protect it from electrostatic discharge.
-  Do not place the memory module in places subject to: Heat sources such as radiators or air ducts, direct sunlight, excessive dust, mechanical vibration or shock, strong magnets or speakers that are not magnetically shielded, ambient temperature of more than +35°C or less than +5°C, or high humidity.
- !** Introducing any liquids or any foreign substances or objects into the memory slots, or other internal components of the computer, will result in damage to the computer and any repairs will be out of warranty.

Adding / replacing a memory module

If you are not familiar with upgrading memory on a computer, we highly recommend that you contact your dealer.

To add or change a memory module, proceed as follows:

- 1 Shut down the computer, unplug it, and remove any peripheral devices. Wait for the computer to cool down.
- 2 Open the unit (see **Opening the side cover (page 54)**).
- 3 To remove an existing memory module, release the end latches and gently lift out the module, as shown (may vary from actual configuration):

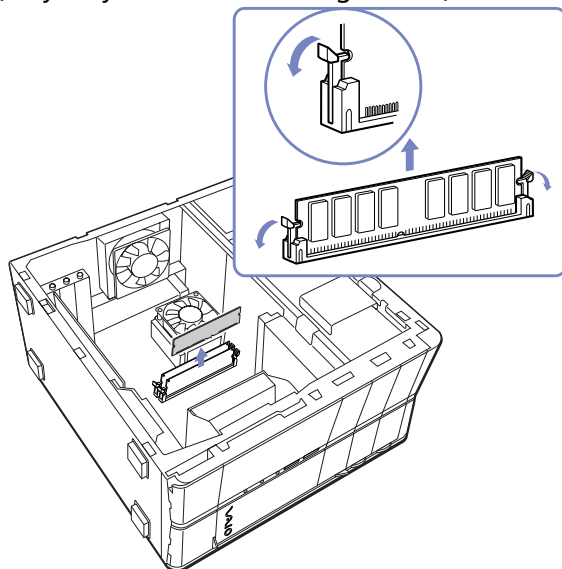

- 4 To insert a new memory module, remove it from its anti-static package, handling it only by the edges.
- 5 Locate the notch on the bottom edge of the memory module.
- 6 Align the memory module over the slot, making sure the module is facing the correct way.
- 7 Press evenly against the memory module's upper corners. The end latches snap into position automatically, as shown:

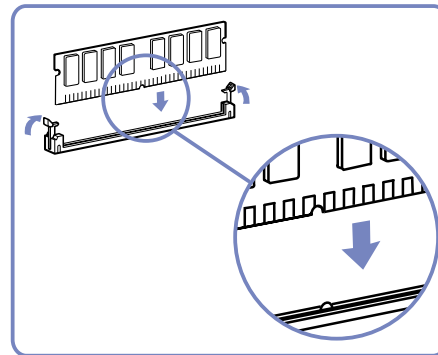
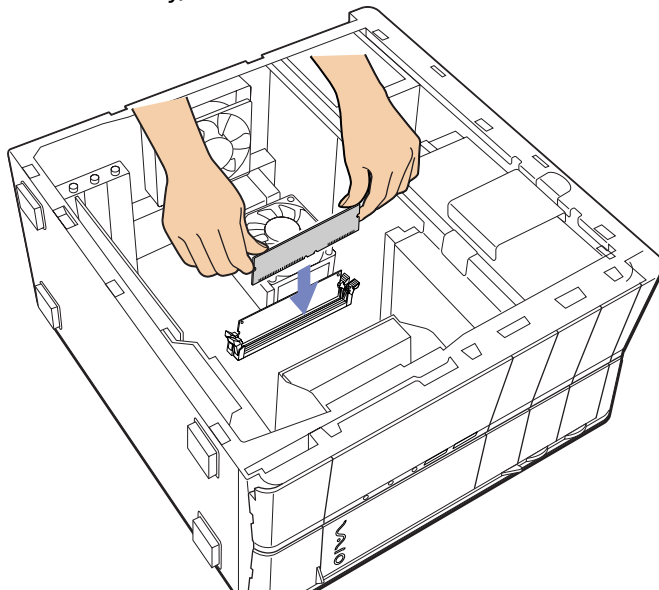

- 8 Reinstall any add-on cards or components you removed.
- 9 Replace the side cover as described in **Closing the side cover (page 59)**.

 There is only one correct way to insert the memory module. Make sure the rivet of the module is lined up with the connector. Use only the memory modules specified on the printed **Specifications** sheet.

Viewing the amount of memory

To view the amount of memory, proceed as follows:

- 1 Turn on the computer.
- 2 Click the **Start** button, point to **All Programs**, then **VAIO System Information**, and click **VAIO System Information** again.

You can view the amount of installed memory here.

Closing the side cover

To replace the side cover, proceed as follows:

- 1 Align the tabs on the side cover to the rim of the unit.
- 2 Press the side cover firmly against the unit until it snaps into place.

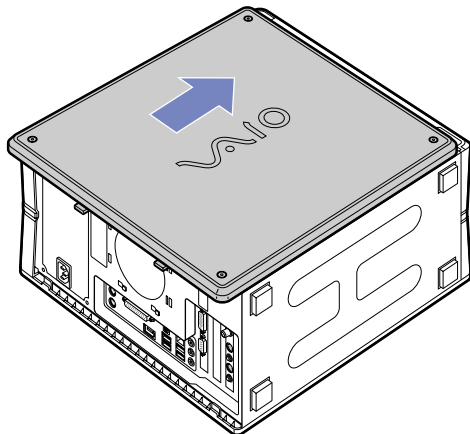

Getting help

This section describes how to get help and support if something goes wrong with your computer. Sony offers you many support options for your computer.

Sony documentation

Please see the section **Documentation pack (page 8)** for details on the printed and online documentation delivered with your computer, as well as further sources of reference.

Other sources of information

- ❑ Go to the **online help files** that accompany your software for instructions on using the software.
- ❑ **VAIO-Link website:** If you have any problems with your computer, you can access the VAIO-Link website for troubleshooting. Go to: www.vaio-link.com
- ❑ **e-Support:** This interactive part of our website www.vaio-link.com allows you to get in contact with our dedicated support team over the internet. Using a personalised account, you can log your technical queries with ease.
- ❑ **VAIO-Link help lines:** Before contacting VAIO-Link by telephone, try to solve the problem by reading the online and printed documentation.
- ❑ Visit the other Sony websites:
 - ❑ www.club-vaio.com if you want to know more about VAIO and become part of the growing VAIO community.
 - ❑ www.sonystyle-europe.com for online purchases.
 - ❑ www.sony.com for other Sony products.



You need to set up an Internet connection before you can access the online features described here.

e-Support

What is e-Support?

You have searched our user guides and website (www.vaio-link.com) but have not found an answer to your question/issue? e-Support is the ideal solution for you!

Our e-Support Web Portal is an interactive website on which you can submit any technical query you may have regarding your VAIO and receive answers from our dedicated support team.

Every submitted query will result in a unique 'case number' to ensure smooth communication between yourself and the e-Support Team.

Who can use e-Support?

All registered VAIO customers are entitled to unlimited access to the VAIO-Link e-Support Web Portal.

How can I access the e-Support portal?

When you register your VAIO computer online at Club-VAIO (www.club-vaio.com), you will automatically receive an email with the link to the e-Support Web Portal, your Customer ID and some basic explanation a few hours later.

All you need to do is activate your account by clicking on the provided link in the email.

You are now ready to create your first case!

You can access the e-Support Web Portal from any computer with an active Internet connection.

A complete help file is available on the e-Support Web Portal to help you use our e-Support Service.

Can I submit questions in my native language?

Since you are interacting with our e-Support Team through a portal, which connects you directly to our central database, e-Support will only accept and deal with queries submitted in English.

Can I submit my questions at any time?

Yes, you can submit your questions 24/7, but please keep in mind that our e-Support Team can only treat your queries from Monday till Friday between 8am and 6pm.

Is there a cost involved for using e-Support?

No, this is a complete free of charge service offered to all registered VAIO customers!

How do I know when the e-Support Team has handled my query/case?

As soon as your case has been dealt with by our e-Support Team, you will receive an email, notifying you that your case has been updated.

Precautions

This section describes safety guidelines and precautions to help you protect your computer from potential damage.

Please contact VAIO-Link if you need assistance.

- ❑ On handling the hard disk ([page 64](#))
- ❑ On using the power source ([page 65](#))
- ❑ On handling your computer ([page 66](#))
- ❑ On handling LCD screens ([page 67](#))
- ❑ On handling floppy disks ([page 68](#))
- ❑ On handling discs ([page 68](#))
- ❑ On handling Memory Sticks ([page 69](#))

On handling the hard disk

The hard disk has a high storage density and reads or writes data in a short time. However, it can be easily damaged by mechanical vibration, shock or dust.

Although the hard disk has the internal safety device to prevent losing data due to mechanical vibration, shock or dust, you should be careful when handling your computer.

To avoid damaging your hard disk:

- Do not subject your computer to sudden movements.
- Keep the computer away from magnets.
- Do not place your computer in a location subject to mechanical vibration or in an unstable position.
- Do not move your computer while the power is on.
- Do not turn off the power or restart the computer while reading or writing data to disk.
- Do not use your computer in a place subject to extreme changes in temperature.

 If the hard disk is damaged, the data cannot be restored.

On using the power source

- ❑ See the printed **Specifications** sheet to check the power operation of your VAIO.
- ❑ Do not share the AC outlet with other high power-consuming equipment, such as a photocopier or shredder.
- ❑ You can purchase a power strip with a surge protector. This device prevents damage to your computer caused by sudden power surges, in an electrical storm, for example.
- ❑ Do not place heavy objects on the power cord.
- ❑ To disconnect the cord, pull it out by the plug. Never pull the cord itself.
- ❑ Unplug your computer from the wall outlet if you are planning to not use the computer for a long time.
- ❑ Make sure that the socket outlet is easily accessible.

On handling your computer

- ❑ Clean the unit with a soft cloth, which is either dry or lightly moistened with a mild detergent solution. Do not use any type of abrasive pad, scouring powder, or solvent such as alcohol or benzene, as these may damage the finish of your computer.
- ❑ Should you drop a solid object or any liquid onto the computer, shut down your computer and then unplug it. You may want to have the computer checked by qualified personnel before operating it again.
- ❑ Do not drop the computer or place heavy objects on top of the computer.
- ❑ Do not place your computer in a location subject to:
 - ❑ Heat sources, such as radiators or air ducts
 - ❑ Direct sunlight
 - ❑ Excessive dust
 - ❑ Moisture or rain
 - ❑ Mechanical vibration or shock
 - ❑ Strong magnets or speakers that are not magnetically shielded
 - ❑ An ambient temperature of more than 35°C or less than 5°C
 - ❑ High humidity.
- ❑ Do not place electronic equipment near your computer. The electromagnetic field of your computer may cause a malfunction.
- ❑ Provide adequate air circulation to prevent internal heat from building up. Do not place your computer on porous surfaces such as rugs or blankets, or near material such as curtains or draperies that may block its ventilation slots.
- ❑ The computer uses high-frequency radio signals and may cause interference to radio or TV reception. Should this occur, relocate the computer a suitable distance away from the set.
- ❑ Use only specified peripheral equipment and interface cables; otherwise, problems may occur.

- ❑ Do not use cut or damaged connection cables.
- ❑ If the computer is brought directly from a cold location to a warm one, moisture may condense inside your computer. In this case, allow at least one hour before turning on your computer. If any problems occur, unplug your computer and contact VAIO-Link.
- ❑ Make sure you disconnect the power cord before cleaning the computer.
- ❑ As you may lose important data once your computer is damaged, you should back up your data regularly. You can restore most of the original application programs from the supplied disc (read the **Guide to Troubleshooting** for details).

On handling LCD screens

- ❑ Do not leave the LCD facing the sun as it can damage the LCD. Be careful when using the computer near a window.
- ❑ Do not scratch the LCD or exert pressure on it. This could cause malfunction.
- ❑ Using the computer in low temperature conditions may produce a residual image on the screen. This is not a malfunction. When the computer returns to normal temperature, the screen returns to normal.
- ❑ A residual image may appear on the screen if the same image is displayed for a lengthy period of time. The residual image disappears in a while. You can use a screensaver to prevent residual images.
- ❑ The screen becomes warm during operation. This is normal and does not indicate a malfunction.
- ❑ The LCD is manufactured using high-precision technology. You may, however, see tiny black points and/or bright points (red, blue, or green) that continuously appear on the LCD. This is a normal result of the manufacturing process and does not indicate a malfunction.
- ❑ Avoid rubbing the LCD screen, as this can damage the screen. Use a soft, dry cloth to wipe the LCD screen.

On handling floppy disks

- ❑ Do not open the shutter manually or touch the surface of the floppy disk.
- ❑ Keep floppy disks away from magnets.
- ❑ Keep floppy disks away from direct sunlight and other sources of heat.

On handling discs

- ❑ Do not touch the surface of the disc.
- ❑ Do not drop or bend the disc.
- ❑ Fingerprints and dust on the surface of a disc may cause reading errors. Always hold the disc by its edge and central hole, as shown.

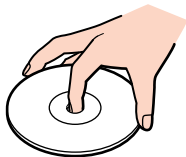

- ❑ Proper care of the disc is essential to its continuous reliability. Do not use solvents such as benzene, thinning agents, commercially available cleaners or anti-static spray, as they may cause damage to the disc.
- ❑ For normal cleaning, hold the disc by its edge and use a soft cloth to wipe the surface from the centre out.
- ❑ If the disc is badly soiled, moisten a soft cloth with water, wring it out well, and use it to wipe the surface of the disc from the centre out. Wipe off any remaining moisture with a dry soft cloth.
- ❑ Never put stickers on discs. This will affect the use of the disc irreparably.

On handling Memory Sticks

- ❑ Do not touch the Memory Stick connector with your finger or metallic objects.
- ❑ Use only the label supplied with the Memory Stick as a label.
- ❑ Do not bend, drop, or apply heavy shock to the Memory Stick.
- ❑ Do not disassemble or modify Memory Sticks.
- ❑ Do not let Memory Sticks get wet.
- ❑ Do not use or store Memory Sticks in a location subject to:
 - ❑ Extremely high temperatures, such as in a car parked in the sun
 - ❑ Direct sunlight
 - ❑ High humidity or
 - ❑ Corrosive substances.
- ❑ Use the storage case supplied with the Memory Stick.

Trademarks

Sony, DVgate, DVgate Plus, Giga Pocket, HotKey Utility, Memory Stick Formatter, PictureGear Studio, SonicStage, SonicStage Mastering Studio, Sony Notebook Setup, Sony Style Imaging, UI Design Selector, VAIO Action Setup, VAIO Edit Components, VAIO Media, VAIO System Information, Memory Stick, the Memory Stick logo, VAIO and the VAIO logo are trademarks of Sony Corporation.

Microsoft, Internet Explorer, Windows Movie Maker, Windows Media Player, Windows XP Professional, Windows XP Home Edition, Microsoft Works and the Windows logo are trademarks or registered trademarks of Microsoft Corporation in the U.S. and other countries.

i.LINK is a trademark of Sony used only to designate that a product contains an IEEE1394 connection.

Adobe, Adobe Acrobat Reader, Adobe Reader, Adobe Premiere LE and Adobe Photoshop Elements are trademarks of Adobe Systems Incorporated.

QuickTime and the QuickTime logo are trademarks used under licence. QuickTime is registered in the U.S. and other countries.

RealOne Player is a trademark or registered trademark of RealNetworks, Inc. in the U.S. and other countries.

MoodLogic is a trademark of MoodLogic, Inc.

PowerPanel is a trademark of Phoenix Technologies Ltd.

Norton Internet Security 2003 is a trademark of Symantec Corporation.

EverQuest is a registered trademark of Sony Computer Entertainment America Inc.

Click to DVD is a trademark of Sony Electronics.

Drag'n Drop CD+DVD is a registered trademark of Easy Systems Japan Ltd.

WinDVD for VAIO is a trademark of InterVideo, Inc.

PowerDVD for VAIO is a trademark or registered trademark of CyberLink Corporation.

SmartMedia is a trademark of Toshiba Co.

CompactFlash is a trademark of US SanDisk Co.

All other names of systems, products and services are trademarks of their respective owners. In the manual, the ™ or ® marks are not specified.

Specifications are subject to change without notice. All other trademarks are trademarks of their respective owners.

Please see the printed Specifications sheet to see what software is available for your model.