

SONY

User Guide

Personal Computer
VGX-TP series



Contents

Before Use	5
Notice	5
Documentation	6
Getting Started	10
Locating Controls and Ports	11
About the Indicator Lights	16
Setting Up Your Computer	17
Shutting Down Your Computer Safely	28
Using Your VAIO Computer	29
Using the Keyboard	30
Using the Touch Pad	34
Using the Optical Disc Drive	35
Using the TV Function	44
Using the Memory Stick Media	53
Using Other Memory Cards	59
Using the Internet	63
Using Wireless LAN (WLAN)	64

Using Peripheral Devices	73
Selecting Display Modes	74
Using the Multiple Monitors Function	75
Connecting a Universal Serial Bus (USB) Device	77
Connecting a Printer	80
Connecting an i.LINK Device	81
Connecting to a Network (LAN)	83
Customizing Your VAIO Computer	85
Setting the Password	86
Setting Up Your Computer with VAIO Control Center	89
Using the Power Saving Mode	90
Upgrading Your VAIO Computer	93
Adding and Removing Memory	94
Precautions	101
On Using the Power Source	102
On Handling Your Computer	103
On Handling Floppy Disks	106
On Handling Discs	107
On Using Headphones	108
On Handling Memory Stick Media	109
On Handling the Hard Disk	110
On Updating Your Computer	111

Troubleshooting	112
Computer	113
System Security	119
Networking	120
Optical Discs	123
Display	127
Printing	130
Microphone	131
Speakers	132
Keyboard	133
Touch Pad	134
Floppy Disks	135
Audio/Video	136
Memory Stick Media	138
Peripherals	139
Support Options	140
Sony Support Information	140
e-Support	141
Trademarks	143

Before Use

Congratulations on your purchase of this Sony VAIO® computer, and welcome to the on-screen User Guide. Sony has combined leading-edge technology in audio, video, computing, and communications to provide state-of-the-art personal computing.

! External views illustrated in this manual may look slightly different from those of your computer.

Notice

© 2007 Sony Corporation. All rights reserved.

This manual and the software described herein, in whole or in part, may not be reproduced, translated, or reduced to any machine-readable form without prior written approval.

Sony Corporation provides no warranty with regard to this manual, the software, or other information contained herein and hereby expressly disclaims any implied warranties or merchantability or fitness for any particular purpose with regard to this manual, the software, or such other information. In no event shall Sony Corporation be liable for any incidental, consequential, or special damages, whether based on tort, contract, or otherwise, arising out of or in connection with this manual, the software, or other information contained herein or the use thereof.

In the manual, the ™ or ® marks are not specified.

Sony Corporation reserves the right to make any modification to this manual or the information contained herein at any time without notice. The software described herein is governed by the terms of a separate user license agreement.

Documentation

Your documentation includes printed information and user guides to read on your VAIO computer.

Printed Documentation

- ❑ **Quick Start Guide** — Describes the process from unpacking to starting up your VAIO.
- ❑ **Troubleshooting and Recovery Guide** — Contains solutions to common problems and computer malfunctions, an explanation of how to make a backup copy of your data and recover your computer system, and sources of support information.
- ❑ **Regulations, Warranty, EULA and Service Support** — Contains Sony **GUARANTEE** conditions, **Safety / Regulations, Modem Regulations, Wireless LAN Regulations, Wireless WAN Regulations, Bluetooth Regulations, End User Software License Agreement**, and **Sony Support services** information.

Non-printed Documentation

- ❑ **User Guide** (this manual) — Explains features of your computer. It also includes information about the software programs included with your computer, as well as information on solving common problems. **User Guide** is provided in the PDF format, which you can easily browse through and print out.

To view this on-screen guide:

- 1 Double-click the **VAIO User Guide** icon on the desktop.
- 2 Open the folder for your language.
- 3 Select the guide you want to read.



You can manually browse to the user guides by going to **Computer > VAIO (C:) (your C drive) > Documentation > Documentation** and opening the folder for your language.

To go to Web sites described in this manual by clicking their respective URLs beginning with http://, your computer must be connected to the Internet.

- ❑ **Specifications** — The online **Specifications** describe the hardware and software configurations of your VAIO computer.

To view the online **Specifications**:

- 1 Connect to the Internet.
- 2 Go to the Sony online support Web site at <http://support.vaio.sony.eu>.



You may have a separate disc for the documentation of bundled accessories.

My Club VAIO

In **My Club VAIO** you can find:

Accessories

Want to expand the capabilities of your computer? Click this icon and have a look at your compatible accessories.

Software

Feeling creative? Click this icon for an overview of your software and check out our upgrade options.

Wallpapers

Click this icon and check out our most popular Sony and Club VAIO wallpapers.

Links

Click this icon and check out our most popular Sony and Club VAIO Web sites.

Windows Help and Support

Windows Help and Support is a comprehensive resource for practical advice, tutorials, and demonstrations to help you learn to use your computer.

Use the Search feature, Index, or table of contents to view all Windows Help resources, including those that are on the Internet.

To access **Windows Help and Support**, click **Start**  and **Help and Support**. Or go to **Windows Help and Support** by pressing and holding the Microsoft Windows key and pressing the **F1** key.

Further Sources

- ❑ Consult the help files on the software you are using for detailed information on features and troubleshooting.
- ❑ Go to <http://www.club-vaio.com> to find online tutorials about your favorite VAIO software.

Getting Started

This section describes how to get started using your VAIO computer.

- ❑ **Locating Controls and Ports** ([page 11](#))
- ❑ **About the Indicator Lights** ([page 16](#))
- ❑ **Setting Up Your Computer** ([page 17](#))
- ❑ **Shutting Down Your Computer Safely** ([page 28](#))

Locating Controls and Ports

Take a moment to identify the controls and ports shown on the following pages.

! The appearance of your computer may be different from those illustrated in this manual due to variations in specifications. It may also vary in some countries or areas.

Top

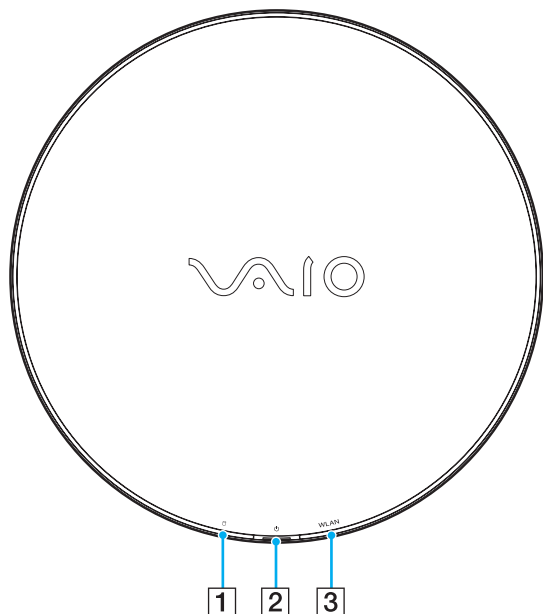

- 1 Hard disk drive/Optical disc drive indicator ([page 16](#))
- 2 Power button/Power indicator ([page 16](#))
- 3 **WLAN** (Wireless LAN) indicator ([page 16](#))

Front

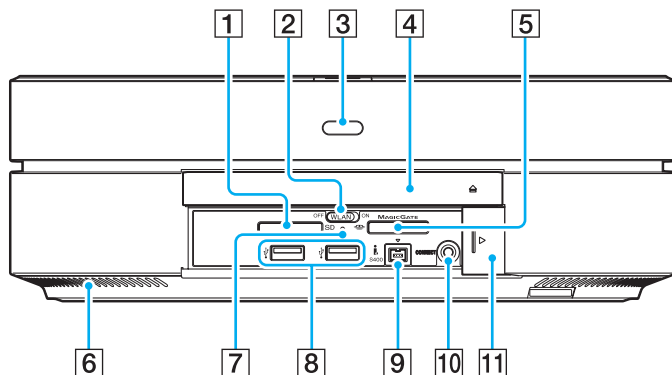

- 1 **SD** memory card slot ([page 59](#))
- 2 **WLAN** (Wireless LAN) switch ([page 64](#))
- 3 Remote sensor/Remote sensor indicator ([page 16](#))
Point the supplied remote commander to this sensor for operations.
- 4 Optical disc drive ([page 35](#))
- 5 Memory Stick slot^{*1} ([page 53](#))
- 6 Air vent
- 7 Media Access indicator ([page 16](#))
- 8 Hi-Speed USB (USB 2.0) ports^{*2} ([page 77](#))
- 9 i.LINK (IEEE 1394) S400 port ([page 81](#))
- 10 **CONNECT** button ([page 25](#))
- 11 Front panel door
To open the front panel door, put your fingertip on the left end of the door and slide it half way to the right. The door will automatically be retracted under the panel. To close the door, slide it half way to the left. The door will keep sliding on its own and shut.

*1 Your computer supports both standard- and Duo-size Memory Stick media.

*2 Support high-/full-/low- speeds.

Back

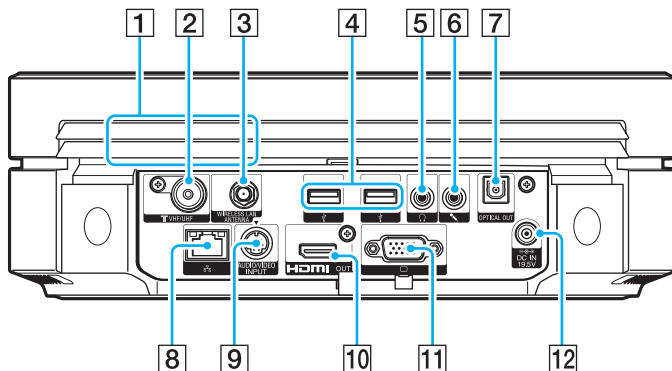

HDMI™
HIGH-DEFINITION MULTIMEDIA INTERFACE

! The area around the air vent (1) becomes hot while your computer is on. Be sure to wait until the computer cools down before you touch it.

- 1 Air vent
- 2 **VHF/UHF** input port (page 44)
- 3 **WIRELESS LAN ANTENNA** port (page 66)
- 4 Hi-Speed USB (USB 2.0) ports* (page 77)
- 5 Headphones jack
Connect external headphones.
- 6 Microphone jack
Connect an external microphone.
- 7 **OPTICAL OUT** port
(Output Sampling Rate: 44.1 KHz/48.0 KHz/96.0 KHz)
Connect an S/PDIF device such as digital headphones or an AV amplifier.
- 8 Network (Ethernet) port (page 83)
- 9 **AUDIO/VIDEO INPUT** port
Connect an external device such as a VCR.
- 10 **HDMI OUT** port (page 18)
- 11 Monitor (VGA) port (page 20)
- 12 **DC IN** port (page 21)

* Support high-/full-/low- speeds.

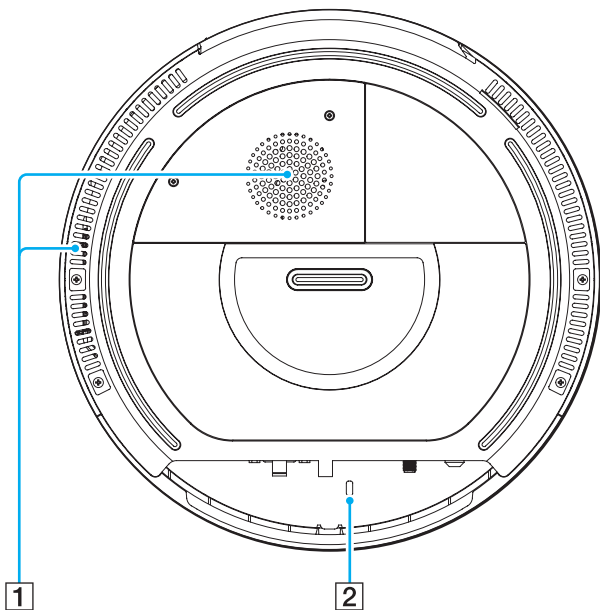

Bottom



- 1 Air vents
- 2 Security slot

About the Indicator Lights

Your computer is equipped with the following indicator lights.

Indicator	Functions
Power 	The indication behavior varies depending on the state of your computer: Green lit: the computer is on. Orange lit: the computer is in Sleep mode. Off: the computer is off.
Media Access	Illuminates when data is read from or written to a memory card. (Do not enter Sleep mode or turn off the computer when this indicator is on.) When the indicator is off, the memory card is not being used.
Hard disk drive/Optical disc drive 	Illuminates when data is read from or written to the hard disk drive or the optical disc media. Do not enter Sleep mode or turn off the computer when this indicator is on.
Wireless LAN	Illuminates when the wireless LAN functionality is enabled.
Remote sensor	Illuminates upon reception of infrared signals from the remote commander.

Setting Up Your Computer

Connecting a Display

Connect a display (not supplied) to your computer. When connecting it, see the manual that came with your display as well.

To connect a display (HDMI-compatible TV)



If your TV is equipped with a DVI-D port, you can use the HDMI cable and the HDMI to DVI-D adapter (both supplied) for connection. To use them for connection, however, you also need an audio cable (not supplied) since no audio signals are carried through the DVI-D port.

- 1 Plug one end of the HDMI cable (supplied) (1) to the **HDMI OUT** port (2) on the computer.
- 2 Plug the other end to the display (TV) (3).

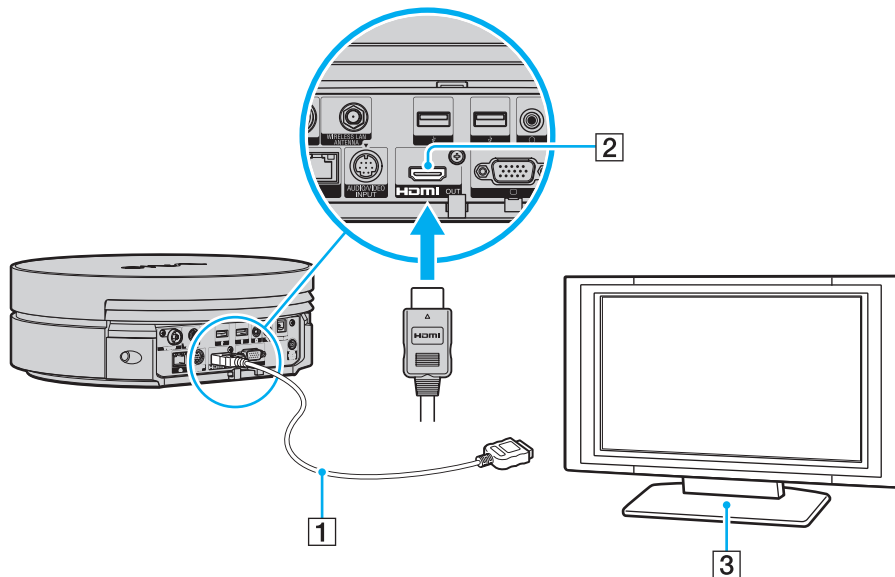

! If your TV is equipped with an HDMI port and a DVI-D port, we recommend that you use the HDMI port.

The HDMI cable carries both video and audio signals.

If a device driver other than the one provided by Sony is used, the image will not be displayed and the audio will not be heard. Always use the device driver provided by Sony for updates.

Your computer is compliant with the HDCP standard and capable of encrypting the transmission channel of digital video signals for the purpose of copyright protection, which enables you to play and view a wide variety of copyright protected, high-quality contents. Note that you need to connect an HDCP-compliant external display to your computer to view the copyright protected contents. If your computer has a non-compliant display connected, you will not be able to play or view any copyright protected contents, including Blu-ray movie contents.

To change the sound output device

If you do not hear sound from the device connected to the **HDMI OUT** port, you need to change the device for sound output.

- 1 Close all open programs.
- 2 Click **Start** and **Control Panel**.
- 3 Click **Hardware and Sound**.
- 4 Click **Manage audio devices** under **Sound**.
- 5 On the **Playback** tab, select the desired device for sound output and click **Set Default**.

To connect a display (monitor)

- 1 If you want to connect a VGA monitor, connect the display cable (1) (not supplied) into the monitor (VGA) port (2) on the back of the computer.
- 2 If necessary, plug the display cable into the display.

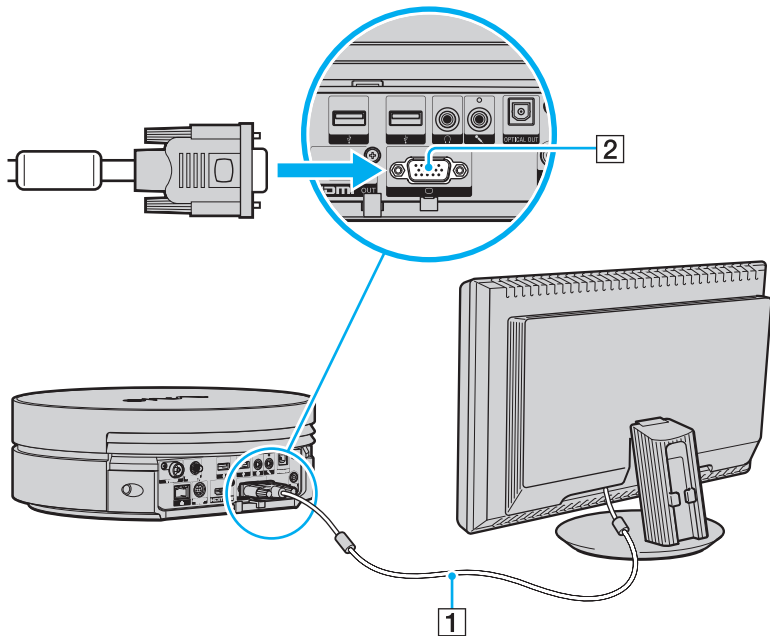

Connecting a Power Source

You need an AC adapter to connect to an AC power source and it must be plugged into the power source before you can establish communication with your wireless keyboard.



Use your computer only with the supplied AC adapter.

To connect the AC adapter

- 1 Plug one end of the power cord (1) into the AC adapter (3).
- 2 Plug the other end of the power cord and the power cord from your display (TV) into AC outlets (2).
- 3 Route the cable from the AC adapter (3) through the hooks (4) on the back of your computer and plug it into the **DC IN** port (5).

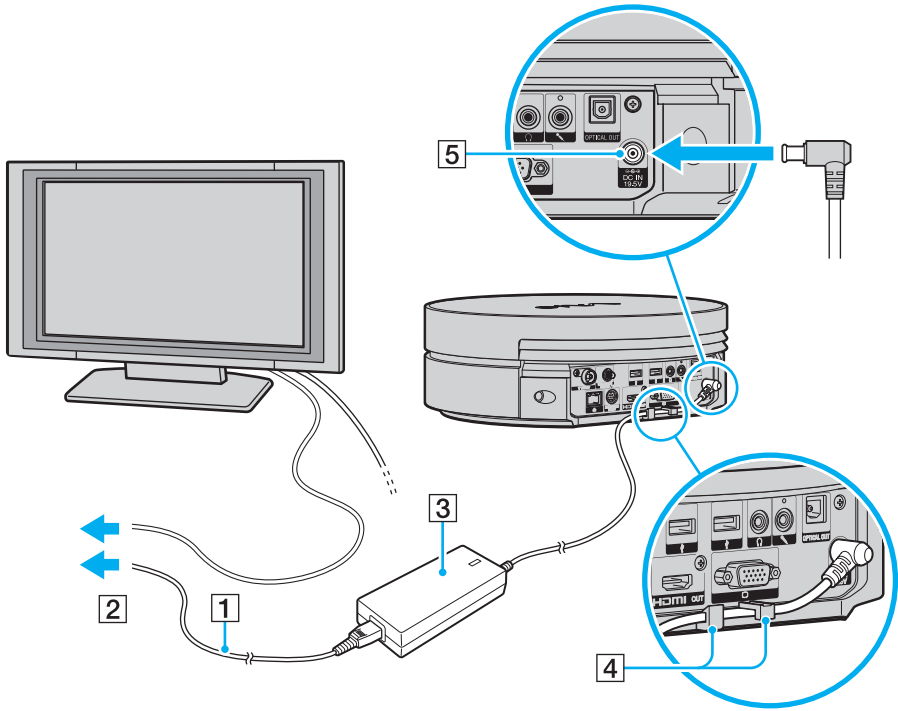



To disconnect your computer completely from AC power, unplug the power cord.

Make sure that the AC outlets are easily accessible.



If you unplug the AC adapter from your computer while the computer is on or in Sleep mode, you may lose all unsaved data.

Attaching the Rear Cover

An exclusively designed rear cover is supplied with your computer for port protection and tidy cabling. Once you have set up your computer, attach the rear cover. Be sure to hold the cover with your both hands when attaching it.

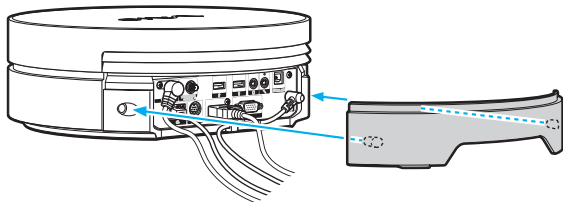

! You may not be able to attach the rear cover depending on the shape or size of connected cable plugs. In such a case, leave the rear of your computer uncovered and keep the rear cover at hand.

To remove the rear cover, grasp the cover as illustrated below and pull it away from the computer.

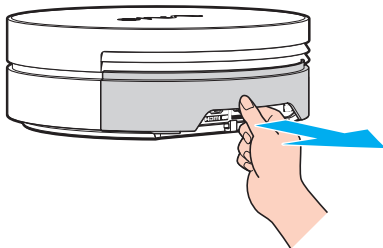

! Do not leave the removed rear cover on the floor. Stepping on it may hurt your foot.

Connecting the Wireless Keyboard

A wireless keyboard and four AA alkaline batteries for use in the keyboard are supplied with your computer. Before attempting to use the wireless keyboard, you must install the batteries and establish communication between the computer and the keyboard.

To connect the wireless keyboard



To connect your wireless keyboard, it must be located within a range of 30 cm to 1 m from the computer.

- 1 Turn over the wireless keyboard.
- 2 Press the button (1) on the battery compartment cover and slide and lift the cover in the direction of the arrow to remove the cover.

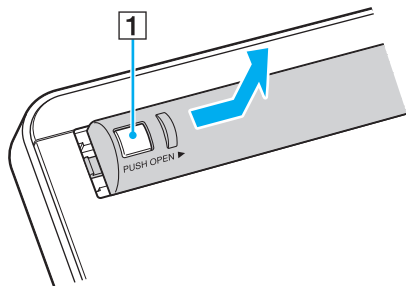

- 3 Insert the supplied four AA batteries into the battery compartment as illustrated below:

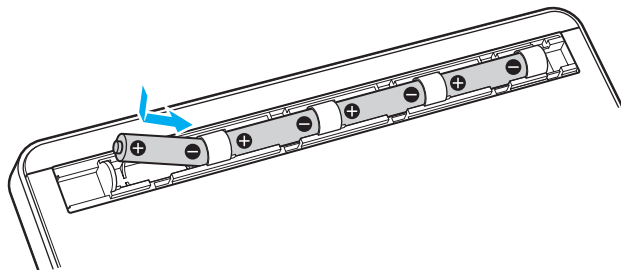

- 4 Turn on the computer.
- 5 Slide the power switch (2) on the keyboard to the **ON** position.
- 6 Press the **CONNECT** button (3) on the front of the computer.
- 7 Press the **CONNECT** button (4) on the bottom of the keyboard.

The connect indicator Υ turns on in the LCD window on the keyboard when connection is established between the computer and the keyboard. If not, repeat the procedure.

! Steps 6 and 7 must be completed within 10 seconds of each other.

If the wireless keyboard is left unused for 20 minutes or longer, the connect indicator Υ will turn off. This could indicate that the connection between your computer and the keyboard is lost. Press the **Fn** key to check that the connect indicator turns on before using the keyboard.

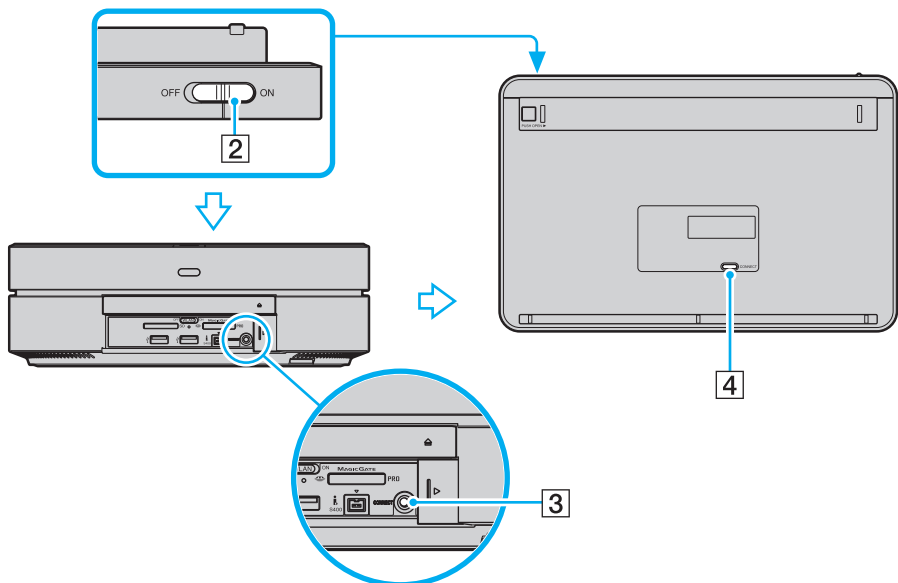

You can check the battery indicator (or) in the LCD window on the wireless keyboard for its battery power level.

If the wireless keyboard does not operate properly, the batteries may need to be replaced. If the wireless keyboard is not being used for an extended period of time, remove the batteries to avoid possible damage from battery leakage.

Shutting Down Your Computer Safely

To avoid losing unsaved data, be sure to shut down your computer properly, as described below.

To shut down your computer

- 1 Turn off any peripherals connected to the computer.
- 2 Click **Start**, the arrow  next to the **Lock** button, and **Shut Down**.
- 3 Respond to any prompts warning you to save documents or to consider other users and wait for the computer to turn off automatically.
The power indicator light turns off.

Using Your VAIO Computer

This section describes how to get the most out of using your VAIO computer.

- ❑ **Using the Keyboard** ([page 30](#))
- ❑ **Using the Touch Pad** ([page 34](#))
- ❑ **Using the Optical Disc Drive** ([page 35](#))
- ❑ **Using the TV Function** ([page 44](#))
- ❑ **Using the Memory Stick Media** ([page 53](#))
- ❑ **Using Other Memory Cards** ([page 59](#))
- ❑ **Using the Internet** ([page 63](#))
- ❑ **Using Wireless LAN (WLAN)** ([page 64](#))

Using the Keyboard

A wireless keyboard is supplied with your computer.

The wireless keyboard uses a standard key arrangement with additional keys that perform specific functions.

The VAIO-Link Web site (<http://www.vaio-link.com>) also contains glossary information to help you use the keyboard.

Using the Wireless Keyboard

!
To maintain good communication, operate the wireless keyboard within the distance limitations of keyboard: 10 m from your computer.

Confirm that the supplied AA batteries are properly installed.

Press the **CONNECT** button located on the front of your computer first, and then press the **CONNECT** button on the bottom of the wireless keyboard.

Avoid using any wireless devices that exchange radio signals on the 2.4 GHz frequency band near the wireless keyboard. These devices may cause interference, causing the keyboard to stop working properly.

Do not place metal furniture near your computer or wireless keyboard, as this may create interference, causing the keyboard to stop working properly.

Do not mix old (used) and new batteries when replacing batteries in the wireless keyboard. Always use the same type and manufacture of battery.

Do not mix alkaline with manganese batteries. Using incompatible batteries or mixing used, new or different types of batteries can damage the wireless keyboard.

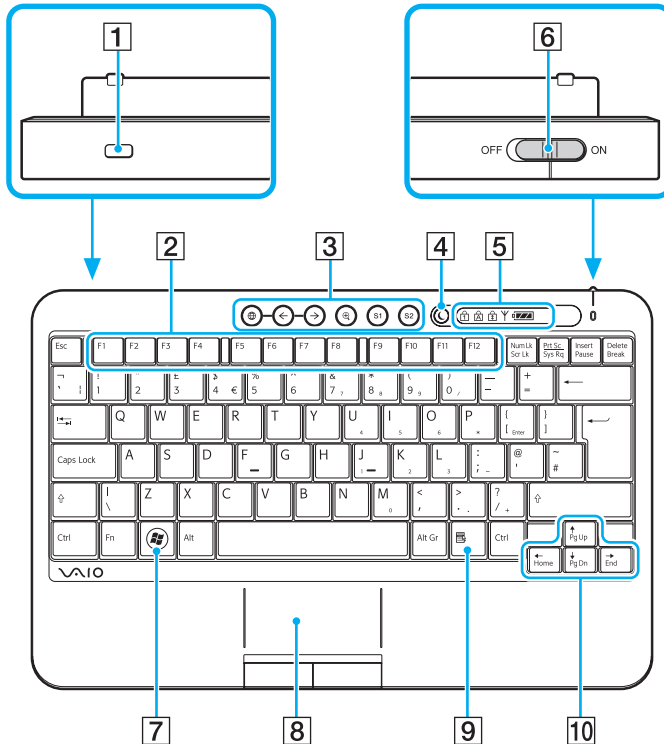

Illustrated above is the English keyboard as an example.

- 1 Security slot
- 2 Function keys
Perform certain tasks. The task associated with each function key varies among software applications.
- 3 Shortcut buttons
Perform the pre-assigned tasks. The default tasks are as follows:



Launches **VAIO Living Browser**.

←, →: Displays the previous or next page while **VAIO Living Browser** is running.



Magnifies the screen view while **VAIO Living Browser** is running. One press magnifies the contents by 25%. When magnification reaches 175%, it goes back to 100%.

S1: Opens the **Media Center Start** menu.

S2: Launches **Resolution Setting Utility**.





The default **S** button assignments may be different from the above. In such a case, you can change the assignments with **VAIO Control Center**. See **Setting Up Your Computer with VAIO Control Center (page 89)** and find out more in its help file.

- 4 Sleep button
Provides for the lower level of power consumption.
For details on power management, see **Using the Power Saving Mode (page 90)**.



5 Indicators

 (Num lock): Turns on while in the Num Lock state.

 (Caps lock): Turns on while in the Caps Lock state.

 (Scroll lock): Turns on while in the Scroll Lock state.

 (Connect): Turns on while connection between the computer and the wireless keyboard is in place to indicate that the keyboard is ready for use ([page 25](#)).

 (Battery):  turns on while the AA batteries for the wireless keyboard are sufficient and switches to  when the batteries wear out.

6 Power switch

Slide the power switch to turn on and off the wireless keyboard.

7 Windows key

Displays the **Start** menu.

8 Touch pad

See **Using the Touch Pad (page 34)** for more information.

9 Applications key

Displays a shortcut menu in certain software applications.

10 Directional arrow keys

Move the pointer on the screen.

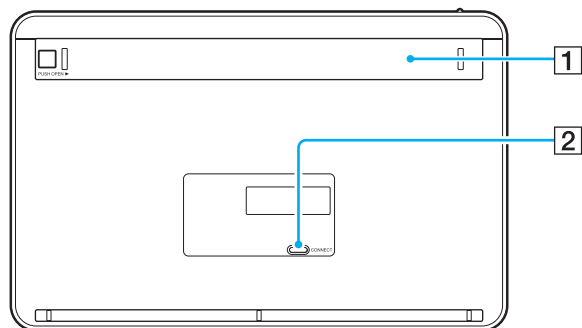

- 1** Battery compartment
Storage compartment for the AA batteries.
- 2** **CONNECT** button ([page 25](#))
Press to enable the wireless keyboard to communicate with the computer.

Using the Touch Pad

You can point to, select, drag, and scroll objects on the screen using the touch pad.

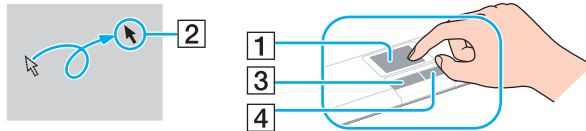

Action	Description
Point	Slide your finger on the touch pad (1) to place the pointer (2) on an item or object.
Click	Press the left button (3) once.
Double-click	Press the left button twice.
Right-click	Press the right button (4) once. In many applications, this action displays a shortcut menu.
Drag	Slide your finger on the touch pad while pressing the left button.
Scroll	Slide your finger along the right edge of the touch pad to scroll vertically. Slide your finger along the bottom edge to scroll horizontally (the scroll function is available only with applications that support a touch pad scroll feature).



To keep moving the pointer or scrolling, slide and hold your finger at the edge of the touch pad.



If pointer movement or scrolling continues against your intention, your fingertip may have reached an edge of the touch pad. In such a case, take your finger off the touch pad. It is recommended that you put your finger on the touch pad around its center to start an operation.

Using the Optical Disc Drive

Your computer is equipped with an optical disc drive.

To insert a disc

- 1 Turn on the computer.
- 2 Push in the optical disc drive tray with your fingertip to eject it.
- 3 Grasp the tray and gently pull it out.

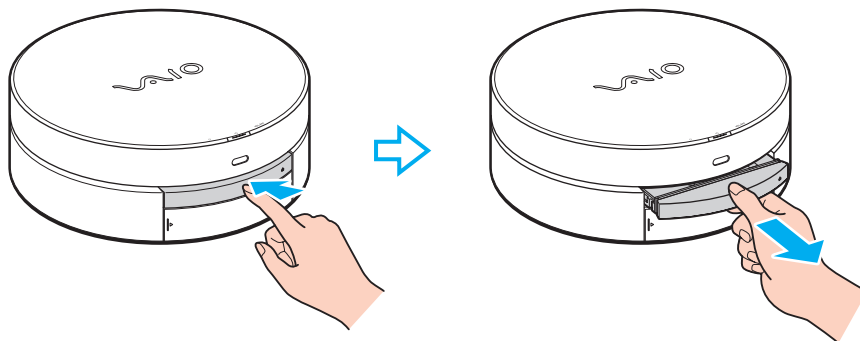

- 4 Place a disc in the middle of the tray with the label side facing upward; and gently push it until the disc clicks into place while holding the bottom of the tray with the other hand.

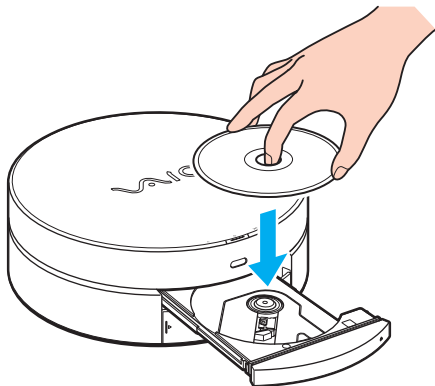

! When the optical disc drive tray is out, be sure not to exert pressure on the tray as it may damage the tray or the disc drive.

- 5 Close the tray by pushing it in gently.

! Do not remove the optical disc when your computer is in Sleep mode. Doing so may cause the computer to malfunction.

Before removing the optical disc, make sure that the optical disc drive indicator light is off.

Reading and Writing Optical Discs

Your computer plays and records CDs, DVDs, and Blu-ray Discs™, depending on the model you purchased. Check your specifications for the type of optical disc drive installed on your model. Use the table below to see which types of media your optical disc drive supports.

PR: playable and recordable
 P: playable but not recordable
 -: not playable or recordable

	CD-ROM	Video CD	Music CD	CD Extra	CD-R/RW	DVD-ROM	DVD-Video	BD-ROM	DVD-R/RW	DVD+R/RW	DVD+R DL	DVD-R DL	DVD-RAM	BD-R ^{*9} /RE ^{*10}
DVD±RW/±R DL/RAM	P	P	P	P	PR	P	P	-	PR ^{*1 *2}	PR	PR ^{*5}	PR ^{*6}	PR ^{*3 *4}	-
CD-RW/DVD-ROM	P	P	P	P	PR	P	P	-	P	P	P	P	-	-
DVD-ROM	P	P	P	P	P	P	P	-	P	P	P	P	-	-
Blu-ray Disc	P	P	P	P	PR ^{*8}	P	P	P	PR ^{*1 *2}	PR	PR ^{*5}	PR ^{*6}	PR ^{*3 *4}	PR ^{*7 *11}
Blu-ray Disc Combo	P	P	P	P	PR ^{*8}	P	P	P	PR ^{*1 *2}	PR	PR ^{*5}	PR ^{*6}	PR ^{*3 *4}	P ^{*11}

^{*1} Supports writing data to DVD-R discs compliant with DVD-R for General Version 2.0/2.1.

^{*2} Supports writing data to DVD-RW discs compliant with DVD-RW Version 1.1/1.2.

^{*3} The DVD±RW/RAM disc drive on your computer does not support the DVD-RAM cartridge. Use non-cartridge discs or discs with removable cartridge.

^{*4} Writing data to single-sided DVD-RAM discs (2.6 GB) compliant with DVD-RAM Version 1.0 is not supported. DVD-RAM Version 2.2/12X-SPEED DVD-RAM Revision 5.0 disc is not supported.

^{*5} Writing data to DVD+R DL (Double Layer) discs is available only on discs supporting DVD+R DL (Double Layer) recording.

^{*6} Writing data to DVD-R DL (Dual Layer) discs is available only on discs supporting DVD-R DL (Dual Layer) recording.

^{*7} Supports writing data to BD-R Version 1.1 discs (single-layer discs with the capacity of 25 GB, dual-layer discs with the capacity of 50 GB) and BD-RE Version 2.1 discs (single-layer discs with the capacity of 25 GB, dual-layer discs with the capacity of 50 GB).

^{*8} Writing data to Ultra Speed CD-RW discs is not supported on models with the Blu-ray Disc drive.

^{*9} BD-R stands for Blu-ray Disc-Recordable in Version 1.1 format.

^{*10} BD-RE stands for Blu-ray Disc-Rewritable in Version 2.1 format.

^{*11} The Blu-ray Disc drive on your computer does not support BD-RE version 1.0 discs and Blu-ray cartridge discs.

! This product is designed to playback discs that conform to the Compact Disc Digital Audio standard specifications (CD Standard). A DualDisc is a two sided disc product which mates DVD recorded material on one side with digital audio material on the other side. Be aware that the audio side (non-DVD side) of a DualDisc may not play on this product because it does not conform to the CD Standard.

Due to the multiple formats of discs now available, when buying pre-recorded or blank discs for use with a VAIO computer, be sure to read the notices on the disc packaging carefully to check both playback and recording compatibility with your computer's optical disc drives. Sony does NOT guarantee the compatibility of VAIO CD drives with discs that are not compliant with the official "CD" format standard (or "DVD" standard in relation to DVD drives, or "Blu-ray Disc" standard in relation to Blu-ray Disc drives). USING NON-COMPLIANT DISCS CAN CAUSE FATAL DAMAGE TO YOUR VAIO PC OR CREATE SOFTWARE CONFLICTS AND CAUSE SYSTEM HANGING.

For inquiries about disc formats, contact the individual publisher of the pre-recorded disc or the manufacturer of the recordable disc.



8cm disc writing is not supported.

! To play copyright protected Blu-ray Discs continuously, you need to update the AACS key. Note that the AACS key update requires Internet access.

As with other optical media devices, circumstances may limit compatibility or prevent Blu-ray Disc playback. VAIO computers may not support movie playback on packaged media recorded in AVC or VC1 formats at high bit rates.

Region settings are required for movies and BD-ROM contents. If the region setting on the optical disc drive does not match the region coding on the disc, playback is not possible.

Unless your external display is compliant with the High-bandwidth Digital Content Protection (HDCP) standard, you cannot play or view the contents of copyright protected Blu-ray Discs.

Some contents may restrict video output to be standard definition or prohibit analog video output at all. It is strongly recommended that digital HDCP-compliant environment be implemented for optimum compatibility and viewing quality.

Notes on writing data to a disc

- ❑ Use only Sony recommended software, which is preinstalled on your computer, to write data to a disc. Other software programs may not be fully compatible and errors may result.
- ❑ To make data on a disc readable on the optical disc drive, you need to close the session before you eject it. To complete this process, follow the instructions included with your software.
- ❑ Only use circular discs. Do not use discs in any other shape (star, heart, card, etc.), as this may damage the optical disc drive.
- ❑ Do not strike or shake your computer while writing data to a disc.
- ❑ Deactivate the screen saver and exit anti-virus software before writing data to a disc.
- ❑ Do not use memory-resident utility software while writing data to a disc. This may cause your computer to malfunction.
- ❑ Before using your software application to burn discs, make sure you exit and close all other applications.
- ❑ Do not place your computer into the power saving mode while using the preinstalled software or any disc burning software.
- ❑ Make sure you use the same disc burning software to add data to a used disc. Use of different disc burning software for additional data burning may cause a failure. For example, if you have a disc with data that you burned with the **Roxio Easy Media Creator** software, use the **Roxio Easy Media Creator** software to add more data to the same disc.

Notes on playing discs

To achieve optimum performance when playing discs, you should follow these recommendations.

- ❑ Some CD players and computers' optical disc drives may not be able to play audio CDs created with the CD-R or CD-RW disc media.
- ❑ Some DVD players and computers' optical disc drives may not be able to play DVDs created with the DVD+R DL, DVD-R DL, DVD+R, DVD+RW, DVD-R, DVD-RW, or DVD-RAM disc media.
- ❑ Do not use memory-resident utility software to speed up disc access when playing a disc. This may cause your computer to malfunction.
- ❑ Do not place your computer into the power saving mode while your computer is playing a disc.
- ❑ Region code indicators are labeled on the DVDs to indicate in which region and on what type of player you can play the disc. Unless a "2" (Europe belongs to region "2") or "all" (this means that you can play this DVD in most regions of the world) is labeled on your DVD disc or on the packaging, you cannot play the disc on your computer.



If you change the DVD region code while the **WinDVD** or **WinDVD BD** software is running, restart the software or eject the disc and re-insert it to make the new setting effective.

- ❑ Do not try to change the region code settings of the DVD drive. Any difficulties caused by changing the region code settings of the DVD drive are out of warranty.

Playing CDs

To play an audio CD

- 1 Insert a disc into the optical disc drive.
- 2 If nothing appears on the desktop, then click **Start, All Programs**, and the desired CD software to play the CD.
If the **Audio CD** window appears, click to select an option.

Copying Files to CDs

To copy files to a disc

! Do not strike or shake your computer while writing data to a disc.

- 1 Insert a disc into the optical disc drive.
If the **AutoPlay** window appears, click **Burn files to disc** and follow the on-screen instructions until the empty disc folder appears.
- 2 Open the folder that contains the file(s) you want to copy and drag them to the empty disc folder.
- 3 Close the disc folder.

Playing DVDs

To play a DVD

- 1 Close all running software applications.
- 2 Insert a DVD into the optical disc drive.
- 3 If nothing appears on the desktop, then click **Start, All Programs**, and the desired DVD software to play the DVD.

For instructions on how to use the software, see the help file on your DVD software.

Copying Files to DVDs

To copy files to a disc

- 1 Insert a disc into the optical disc drive.
- 2 If nothing appears on the desktop, then click **Start, All Programs**, and the desired DVD software to copy files to the disc.

For instructions on how to use the software, see the help file on your DVD software.

Using the TV Function

Your computer may have a hybrid TV tuner board installed along with the **Microsoft Windows Vista Home Premium** operating system which includes **Windows Media Center** that enables TV program viewing, recording, and playback.

The hybrid TV-tuner supports the following broadcasts:

- ❑ Analog cable and terrestrial TV:
Systems: B/G/I/D/K/L/L'
Color systems: PAL and SECAM
Frequency band: 48.25 MHz - 855.25 MHz
- ❑ Digital terrestrial TV (DVB-T) and Digital TV:
System: DVB-T
Video system: MPEG2
Frequency band: 48.25 MHz - 855.25 MHz

! Any functions related to digital terrestrial television (DVB-T) will only work in countries or areas where DVB-T MPEG2 digital terrestrial TV signals are broadcasted. Make sure you can receive a DVB-T MPEG2 signal where you live.

To connect your computer to terrestrial or cable TV services

! The appearance of the antenna/cable-TV cable and the **VHF/UHF** input port may vary in some countries or areas.

- 1 Connect one end of an antenna/cable-TV cable (supplied) (1) to the **VHF/UHF** input port (3) on the computer.
- 2 Connect the other end of the cable to your TV wall outlet/cable service access (2).

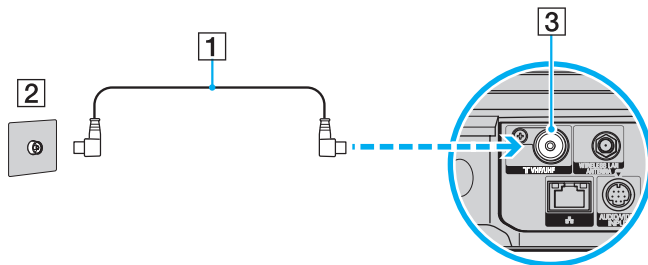

Using the Remote Commander

A remote commander is supplied with your computer for using Media Center features, including TV channel selection.

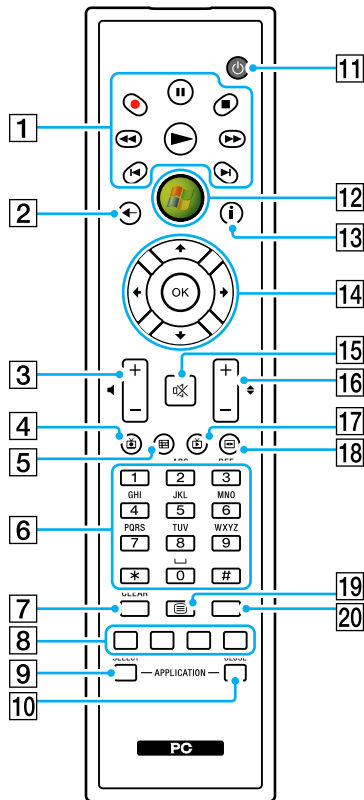

- 1** Pause **||** button
Press to pause media playback. Press again to resume playback.
Stop **■** button
Press to stop media playback or TV recording session.
Forward **▶▶** button
Press to fast-forward media at three speeds.
Skip **▶I** button
Press to move media forward, for example, one audio track, one DVD chapter, and 30 seconds of recorded TV or video.
Replay **I◀** button
Press to move media backward, for example, one audio track, one DVD chapter, and 7 seconds of TV or video.
Rewind **◀◀** button
Press to move media backward at three speeds.
Record **●** button
Press to begin recording.
Play **▶** button
Press to begin media playback.
- 2** Back button
Press to return to the previous window.
- 3** Volume buttons
Press to increase (+) or decrease (-) the volume.
- 4** Recorded TV button
Press to view previously recorded TV programs (In **My TV** window).

- 5** Guide button
Press to view the TV program guide for your area.
- 6** Alphanumeric buttons
Press to select specific channels or enter text. (Press **ENTER** or **OK** to activate the channel selection.)
- 7** **CLEAR** button
Press to backspace and delete entered text.
- 8** Teletext TV program mode buttons
 - Red button
Press to jump to the red shortcut link in teletext TV program mode.
 - Green button
Press to jump to the green shortcut link in teletext TV program mode.
 - Yellow button
Press to jump to the yellow shortcut link in teletext TV program mode.
 - Blue button
Press to jump to the blue shortcut link in teletext TV program mode.
- 9** **APPLICATION SELECT** button
Press to switch among open applications. This button works the same as the **Alt+Tab** keys.
- 10** **APPLICATION CLOSE** button
Press to close the active application window.
- 11** Sleep button
Press to place the computer into Sleep mode to reduce power consumption.
- 12** Start button
Press to open the **Media Center Start** menu.
- 13** More button
Press to view additional options that are available for Media Center features.
- 14** Directional arrow buttons
Press the **↑**, **↓**, **←**, and **→** buttons to move the pointer on the screen.
OK button
Press to select the desired action or window option. When watching full-screen TV, press to return to the previous channel. Press again to switch between channels.
- 15** Muting button
Press to turn off the sound. Press again to restore the sound.
- 16** Channel/Page buttons
Press to change or page up/down channels (no number input required).
- 17** Live TV button
Press to view TV programs.
- 18** DVD menu button
Press to open the main menu on a DVD.
- 19** Teletext TV program mode selection button
Press to activate/deactivate teletext TV program mode.
- 20** **ENTER** button
Press to activate feature or action, such as channel selection or return to previous channel. (This button's actions are similar to using the **OK** button.)

Controlling your TV volume with the supplied remote commander

You can change the volume on your TV with the supplied remote commander by changing the remote commander's signal setting to match with the one used by your TV manufacturer.

Press and hold the **OK** button and press alphanumeric buttons to enter your TV manufacturer code. For example, press and hold the **OK** button and press the **0** and **2** buttons consecutively to enter the manufacturer code for Sony: Sony (02).

Manufacturer	Code
VAIO computer (default setting)	01
Sony	02
Philips	04, 08, 09, 10, 11
Samsung	03, 05, 07, 08, 11
Sharp	06
LG	03, 05, 07

!

If your TV manufacturer has more than one manufacturer code, you may not be able to control the TV volume with the remote commander even though you have specified one of them for matching the signal setting. In such a case, try another code.

Changes to this signal setting for the TV volume control may not work on some TVs. Sony assumes no liability for the controllability.

Before you use the remote commander

Before using the remote commander, you need to insert the supplied AA manganese batteries to enable communication between the computer and the remote commander.

To insert batteries

- 1 Turn the remote commander over.
- 2 Slightly push down the dented area (1), slide the battery cover in the direction of the arrow, and remove the cover.

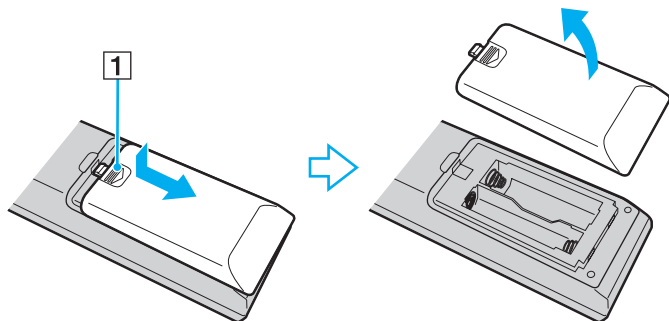

- 3 Insert the supplied two AA batteries into the remote commander.

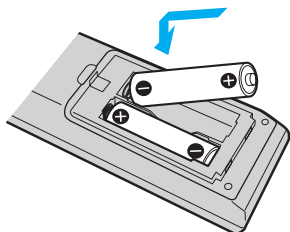

- 4 Put the battery cover back on the remote commander and slide it in the reverse direction of the arrow illustrated above until the cover clicks into place.



If the remote commander does not operate properly, you may need to replace the batteries. When the remote commander is not going to be used for an extended period of time, remove the batteries to avoid possible damage from battery leakage.

Setting up Windows Media Center

The first time you launch **Windows Media Center**, the setup wizard will pop up. To configure the TV tuner, click **Custom setup** and follow the on-screen instructions. In the **Optional Setup** window, click **Configure tuners, TV signal**, and **Guide**, and follow the on-screen instructions.

In case the TV tuner was not configured during the first run of **Windows Media Center**, you can do this by selecting **set up TV** in the **TV + Movies** section.

When you want to change TV input signal (TV Signal or TV Signal Type) or change location, click **settings** in the **Tasks** section and then click **TV**.

Note that in this case a new channel scan needs to be done and that the previous channel list and **Guide** information is lost and that scheduled timer recordings are cancelled.

Using the Memory Stick Media

Memory Stick media is a compact, portable, and versatile IC recording media especially designed for exchanging and sharing digital data with compatible products, such as digital cameras, mobile phones and other devices. Because it is removable, it can be used for external data storage.



The Memory Stick slot is located behind the front panel door. You need to open this door before accessing the slot.

Before You Use the Memory Stick Media

The Memory Stick slot on your computer can accommodate both standard- and Duo-size media and support Memory Stick PRO and Memory Stick PRO-HG Duo media with high speed and high capacity capabilities.



You can insert a Duo-size Memory Stick media directly into the Memory Stick slot without using a Memory Stick Duo Adaptor.



Before using a Memory Stick Micro (M2) media, be sure to insert it into an M2 Standard-size or M2 Duo-size Adaptor. If you insert the media directly into the Memory Stick slot without the Adaptor, you may not be able to remove it from the slot.

For the latest information about the Memory Stick media, visit the Memory Stick Web site at <http://www.memorystick.com/en/>.



Your computer has been tested and found compatible with the Sony branded Memory Stick media with capacity of up to 8 GB that are available as of May 2007. However, not all Memory Stick media that meet the same conditions as the compatible media are guaranteed of compatibility.

Inserting a Memory Stick media with multiple conversion adaptors is not guaranteed of compatibility.

MagicGate is the general name of the copyright protection technology developed by Sony. Use a Memory Stick media with the MagicGate logo to use this feature.

Besides for your personal enjoyment, it is against the copyright law to use any audio and/or image data you recorded without prior consent from the respective copyright holders. Accordingly, Memory Stick media with such copyrighted data can be used only within the law.

The Memory Stick slot on your computer does not support 8-bit parallel data transfer (high speed data transfer).

The Memory Stick Micro media in an M2 Duo-size Adaptor may not operate properly if it is additionally inserted into a Memory Stick Duo Adaptor.

Inserting a Memory Stick Media

To insert a Memory Stick media

- 1 Slide open the front panel door with your fingertip.
- 2 Locate the Memory Stick slot (page 13).
- 3 Hold the Memory Stick media with the arrow facing upward and pointing toward the Memory Stick slot.
- 4 Carefully slide the Memory Stick media into the slot until it clicks into place.
The Memory Stick media is automatically detected by your system and the content of the Memory Stick media is displayed. If nothing appears on the desktop, click **Start, Computer**, and double-click the Memory Stick media icon.

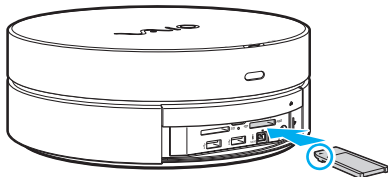

! Be sure to hold the Memory Stick media with the arrow pointing in the correct direction as you insert it into the slot. To avoid damaging your computer or the Memory Stick media, do not force the Memory Stick media into the slot if you cannot insert it smoothly.

Do not insert more than one Memory Stick media into the slot. Improper insertion of the media may damage both your computer and the media.

While the Memory Stick media is in the slot, you cannot close the front panel door. A forceful attempt to close the door may damage both your computer and the media.

To view the contents of the Memory Stick media

- 1 Click **Start** and **Computer** to open the **Computer** window.
- 2 Double-click the Memory Stick media icon to view the list of data files saved in the Memory Stick media.

To format a Memory Stick media

The Memory Stick media has been formatted in the factory default setting and is ready for use. If you want to reformat the media with your computer, follow these steps.

! Be sure to use the device that is designed to format the media and supports the Memory Stick media when formatting the media.

Formatting the Memory Stick media erases the entire data on the media. Before formatting the media, make sure that it does not contain your valuable data.

Do not remove the Memory Stick media from the slot while formatting the media. This could cause a malfunction.

- 1 Carefully slide the Memory Stick media into the slot until it clicks into place.
- 2 Click **Start** and **Computer** to open the **Computer** window.
- 3 Right-click the Memory Stick media icon and select **Format**.
- 4 Click **Restore device defaults**.

! The size of the allocation unit and file system may change.

Do not select **NTFS** from the **File system** drop-down list as it may cause a malfunction.



The formatting process will be completed more quickly if you select **Quick Format** in **Format options**.

- 5 Click **Start**.
- 6 At the confirmation prompt, click **OK**.
The formatting process starts.

! It may take time to format the Memory Stick media depending on the media.
- 7 Once completed, click **OK**.
- 8 Click **Close**.

Removing a Memory Stick Media

To remove a Memory Stick media

- 1 Check that the Media Access indicator light is off.
- 2 Firmly grasp the extended part of the Memory Stick media.
- 3 Carefully pull it out of the slot.



Always remove the Memory Stick media gently, or it may pop out unexpectedly.

Do not remove the Memory Stick media while the Media Access indicator light is on. If you do, you may lose data. Large volumes of data may take time to load, so be sure the indicator is off before removing the Memory Stick media.

Using Other Memory Cards

In addition to the Memory Stick slot, your computer is equipped with an **SD** memory card slot. You can use this slot to transfer data among digital cameras, camcorders, music players, and other audio/video devices.



The **SD** memory card slot is located behind the front panel door. You need to open this door before accessing the slot.

Before You Use Memory Cards

The **SD** memory card slot on your computer supports the following memory cards:

- SD memory card
- SDHC memory card
- MultiMediaCard (MMC)

For the latest information on compatible memory cards, see **Sony Support Information (page 140)** to visit the appropriate support Web site.

! Your computer has been tested and found compatible only with major memory card media available as of May 2007. However, not all memory card media that meet the same conditions as the compatible media are guaranteed of compatibility.

Always insert the correct memory card into the **SD** memory card slot.

SD memory cards with capacity of up to 2 GB and SDHC memory cards with capacity of up to 8 GB have been tested and found compatible with your computer.

The **SD** memory card slot on your computer does not support the copyright protection and high-speed data transfer features of the SD memory card and SDHC memory card.

Do not attempt to insert a memory card or memory card adapter of a different type into the **SD** memory card slot. An incompatible memory card or memory card adapter may cause difficulty in removing from the slot and can cause damage to your computer.

Use care when inserting or removing a memory card from the **SD** memory card slot. Do not force the memory card in or out of the slot.

Inserting a Memory Card

To insert a memory card

- 1 Slide open the front panel door with your fingertip.
- 2 Locate the **SD** memory card slot ([page 13](#)).
- 3 Hold the memory card with the arrow facing upward and pointing toward the memory card slot.

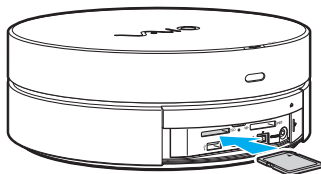

- 4 Carefully slide the memory card into the slot until it clicks into place. Do not force the card into the slot.



If the memory card does not go into the slot easily, remove it gently and verify you are inserting it in the proper direction.



While a memory card is in the slot, you cannot close the front panel door. A forceful attempt to close the door may damage both your computer and the media.

Removing a Memory Card

! Do not remove a memory card while the Media Access indicator light is on. If you do, the card or its data may become damaged.

To remove a memory card

- 1 Check that the Media Access indicator light is off.
- 2 Firmly grasp the extended part of the memory card.
- 3 Carefully pull it out of the slot.

Using the Internet

To use the Internet, you need to connect an external modem device, for example a USB telephone modem, an xDSL modem, or a cable modem, to your computer. For the detailed instructions on connection setups and modem configuration, see the manual that came with your modem.

Using Wireless LAN (WLAN)

Using the Sony Wireless LAN (WLAN), all your digital devices with built-in WLAN functionality communicate freely with each other through a network. A WLAN is a network in which a user can connect to a Local Area Network (LAN) through a wireless (radio) connection. So there is no need anymore to pull cables or wires through walls and ceilings.

You can communicate without an access point, which means that you can communicate with a limited number of computers (ad-hoc). Or you can communicate through an access point, which allows you to create a full infrastructure network.



In some countries, using WLAN products may be restricted by the local regulations (e.g. limited number of channels). Therefore, before activating the WLAN functionality, read the **Regulations Guide** carefully.

WLAN uses the IEEE 802.11a*/b/g standard or the draft form of the IEEE 802.11n* standard, which specifies the used technology. The standard includes the encryption methods: Wired Equivalent Privacy (WEP), which is a security protocol, Wi-Fi Protected Access 2 (WPA2), and Wi-Fi Protected Access (WPA). Proposed jointly by the IEEE and Wi-Fi Alliance, both WPA2 and WPA are specifications of standards based, interoperable security enhancements that increase the level of data protection and access control for existing Wi-Fi networks. WPA has been designed to be forward compatible with the IEEE 802.11i specification. It utilizes the enhanced data encryption TKIP (Temporal Key Integrity Protocol) in addition to user authentication using 802.1X and EAP (Extensible Authentication Protocol). Data encryption protects the vulnerable wireless link between clients and access points. Besides that, there are other typical LAN security mechanisms to ensure privacy, such as: password protection, end-to-end encryption, virtual private networks, and authentication. WPA2, the second generation of WPA, provides stronger data protection and network access control and is also designed to secure all versions of 802.11 devices, including 802.11b, 802.11a, 802.11g, and 802.11n, multi-band and multi-mode. In addition, based on the ratified IEEE 802.11i standard, WPA2 provides government grade security by implementing the National Institute of Standards and Technology (NIST) FIPS 140-2 compliant AES encryption algorithm and 802.1X-based authentication. WPA2 is backward compatible with WPA.

* See the online **Specifications** to see whether your model supports the IEEE 802.11a standard and/or the draft form of the IEEE 802.11n standard.

IEEE 802.11b/g is a wireless LAN standard, using the 2.4 GHz bandwidth. The IEEE 802.11g standard provides high-speed communications, faster than the IEEE 802.11b standard.

IEEE 802.11a is a wireless LAN standard, using the 5 GHz bandwidth, and provides high-speed communications of up to 54 Mbps.

IEEE 802.11n is a wireless LAN standard, using the 2.4 or 5 GHz bandwidth, and provides high-speed communications of up to 300 Mbps*.

* Actual communication speed varies depending on your access point settings and so on.

Your computer may employ the Intel® Next-Gen Wireless-N technology* compliant with the IEEE 802.11a/b/g standard and the draft form of the IEEE 802.11n standard.

* Employed only on models that support the draft form of the IEEE 802.11n standard.

Wireless LAN devices using the 2.4 GHz bandwidth and the ones using the 5 GHz bandwidth cannot communicate with each other because the frequencies are different.

The 2.4 GHz bandwidth used by wireless LAN compatible devices is also used by other various devices. Although technologies to minimize interference from other devices that use the same bandwidth are employed on wireless LAN compatible devices, such interference may cause lower communication speed, narrower communication range, or broken wireless connections.

The communication speed varies depending on the distance between communication devices, existence of obstacles between such devices, the device configuration, the radio conditions, and the software in use. In addition, communications may be cut off depending on the radio conditions.

The communication range varies depending on the actual distance between communication devices, existence of obstacles between such devices, the radio conditions, the ambient environment that includes existence of walls and materials of such walls, and the software in use.

Deploying IEEE 802.11b and IEEE 802.11g products on the same wireless network may reduce the communication speed due to radio interference. Taking this into consideration, the IEEE 802.11g products are designed to reduce the communication speed to ensure communications with IEEE 802.11b products. When the communication speed is not as fast as expected, changing the wireless channel on the access point may increase the communication speed.

Connecting the Wireless LAN Antenna

To use the wireless LAN functionality on your computer, you must connect the supplied wireless LAN antenna to your computer.

To connect the wireless LAN antenna

Screw the wireless LAN antenna cable (1) counterclockwise into the **WIRELESS LAN ANTENNA** port (2) on the back of your computer.

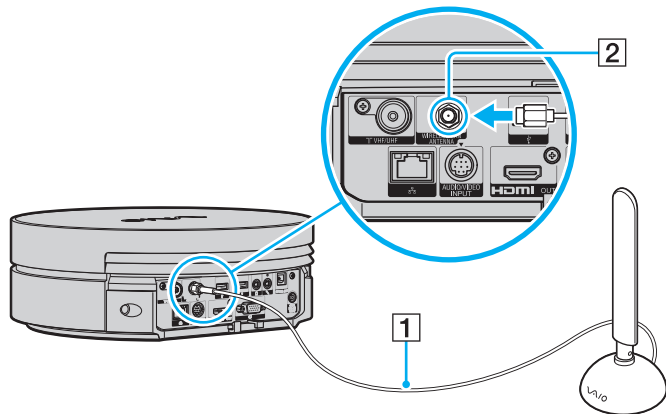

! Be sure to keep the wireless LAN antenna at least 30 cm away from your computer.



For better reception, if needed, you may mount the wireless LAN antenna to a wall using the supplied screw.

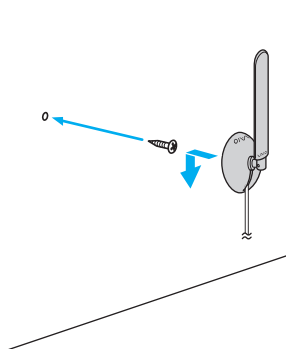

Communicating without an Access Point (Ad-hoc)

An ad-hoc network is a network in which a LAN is created only by the wireless devices themselves, with no other central controller or access point. Each device communicates directly with other devices in the network. You can set up an ad-hoc network easily at home.

- If the wireless connection is initiated by the VAIO computer, channel 11 will be selected.
- If the wireless connection is initiated by peer wireless LAN equipment, the wireless LAN communication will make use of the channel selected by the peer wireless LAN equipment.



To communicate without an access point (ad-hoc)



The IEEE 802.11n standard, using the 2.4 or 5 GHz bandwidth, is not available on ad-hoc networks.

- 1 Turn on the **WLAN** switch.
The Wireless LAN indicator lights up.
- 2 Click **Start** and **Control Panel**.
- 3 Click **View network status and tasks** under **Network and Internet**.
- 4 Click **Set up a connection or network** on the left pane.
The **Set up a connection or network** window appears.
- 5 Select an option to specify the ad-hoc network settings and click **Next**.
- 6 Follow the on-screen instructions.

Communicating with an Access Point (Infrastructure)

An infrastructure network is a network that extends an existing wired local network to wireless devices by providing an access point (not supplied), for example the Sony Access Point. The access point bridges the wireless and wired LAN and acts as a central controller for the wireless LAN. The access point coordinates transmission and reception from multiple wireless devices within a specific range.

The access point will select which channel to use on an infrastructure network.

! For details on how to select the channel that will be used by the access point, see the manual that came with your access point.

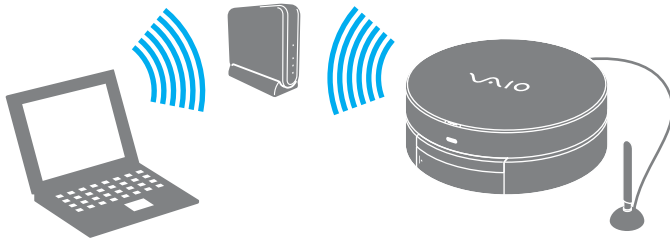

To connect to a wireless network

- 1** Make sure an access point is set up.
See the manual that came with your access point for more information.
- 2** Turn on the **WLAN** switch.
The Wireless LAN indicator lights up.
- 3** Click **Start** and **Control Panel**.
- 4** Click **View network status and tasks** under **Network and Internet**.
- 5** Click **Manage wireless networks**.
- 6** Click **Add**.
- 7** Follow the on-screen instructions.

Stopping Wireless LAN Communication

To stop wireless LAN communication

Turn off the **WLAN** switch.



Turning off the wireless LAN functionality while accessing remote documents, files, or resources may result in data loss.



For WPA-PSK or WPA2-PSK authentication, you must enter a passphrase. The passphrase is case sensitive and must be between 8 and 63 alphanumeric characters long or up to 64 characters long using numbers from 0 to 9 and letters from A to F.

Using Peripheral Devices

You can add functionality to your VAIO computer by using the various ports on the computer.

- ❑ **Selecting Display Modes** ([page 74](#))
- ❑ **Using the Multiple Monitors Function** ([page 75](#))
- ❑ **Connecting a Universal Serial Bus (USB) Device** ([page 77](#))
- ❑ **Connecting a Printer** ([page 80](#))
- ❑ **Connecting an i.LINK Device** ([page 81](#))
- ❑ **Connecting to a Network (LAN)** ([page 83](#))

Selecting Display Modes

You can select which display to be used as the primary monitor when two displays (TV, desktop monitor, etc.) are connected to your computer.

If you want to work on both displays at the same time, see **Using the Multiple Monitors Function (page 75)** for more information.

To select a display

- 1 Right-click on the desktop and select **Personalize**.
- 2 Click **Display Settings**.
The **Display Settings** window appears.
- 3 Follow the on-screen instructions to change the settings.



You may not be able to display the same contents on both displays (including a combination of one display and one projector) at the same time, depending on the type of your display or projector.

Before turning on your computer, turn on the peripheral devices.

Using the Multiple Monitors Function

The Multiple Monitors function allows you to distribute portions of your desktop across separate displays. For example, if you have a display connected to the **HDMI OUT** port and another connected to the monitor (VGA) port, two displays can function as a single desktop.

You can move the cursor from one display to the other. This allows you to drag objects, such as an open application window or a toolbar, from one display to the other.

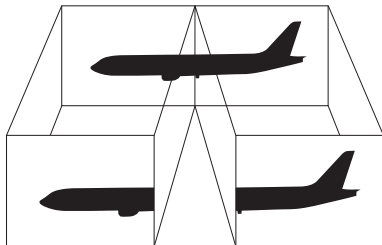

Your external display may not support the Multiple Monitors function.

Certain software applications may not be compatible with Multiple Monitors settings.

Make sure that your computer does not enter Sleep mode while you are using Multiple Monitors mode; otherwise the computer may not return to Normal mode.

If you set different colors on each display, do not expand a single window across two displays; otherwise your software may not work properly.

Set fewer colors or a lower resolution for each display.

To select the Multiple Monitors mode

- 1 Right-click on the desktop and select **Personalize**.
- 2 Click **Display Settings**.
The **Display Settings** window appears.
- 3 Follow the on-screen instructions to change the settings.



Additionally, you can set the display colors and resolution for each display and customize the Multiple Monitors mode.

Connecting a Universal Serial Bus (USB) Device



You need to slide open the front panel door to access the USB ports on the front.

Connecting a USB Mouse

To connect a USB mouse

- 1 Choose the USB port (1)  you prefer to use.
- 2 Plug the USB mouse cable (2) into the USB port.
- 3 You can now use your USB mouse (not supplied) (3).

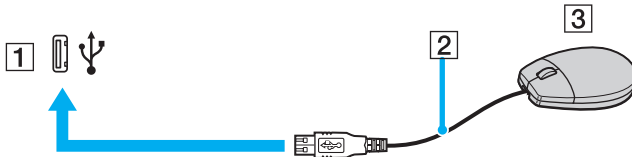

Connecting a USB Floppy Disk Drive

You can purchase a USB floppy disk drive and connect it to your computer.

To connect a USB floppy disk drive

- 1 Choose the USB port (1)  you prefer to use.
 - 2 Plug the USB floppy disk drive cable (2) into the USB port.
- Your USB floppy disk drive (3) is now ready for use.

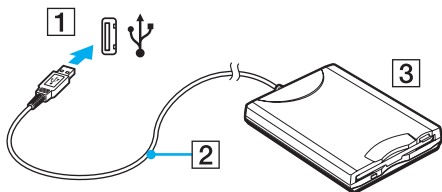

! When using a USB floppy disk drive, do not apply force on the USB port. This may cause a malfunction.

Disconnecting a USB floppy disk drive

You can disconnect a USB floppy disk drive when your computer is on or off. Disconnecting the drive when the computer is in Sleep mode may cause the computer to malfunction.

To disconnect a USB floppy disk drive



To disconnect a USB floppy disk drive when your computer is off, skip steps 1 to 8.

- 1 Close all programs accessing the floppy disk drive.
- 2 Double-click the **Safely Remove Hardware** icon on the taskbar.
The **Safely Remove Hardware** window appears.
- 3 Select the floppy disk drive you want to unplug.
- 4 Click **Stop**.
The **Stop a Hardware device** window appears.
- 5 Confirm that the floppy disk drive can be safely removed from the system.
- 6 Click **OK**.
A message appears stating it is now safe to remove the hardware device.
- 7 Click **OK**.
- 8 Click **Close** to close the **Safely Remove Hardware** window.
- 9 Disconnect the floppy disk drive from the computer.

Connecting a Printer

You can connect a Windows-compatible printer to your computer to print documents.

Connecting a Printer Using the USB Port

You can connect a USB printer compatible with your version of Windows to the computer.



You need to slide open the front panel door to access the USB ports on the front.

To connect a printer using the USB port

- 1 Plug the power cord (1) of your printer into an AC outlet.
- 2 Choose the USB port (3) you prefer to use.
- 3 Plug one end of a USB printer cable (2) (not supplied) into the USB port and the other end to your printer.

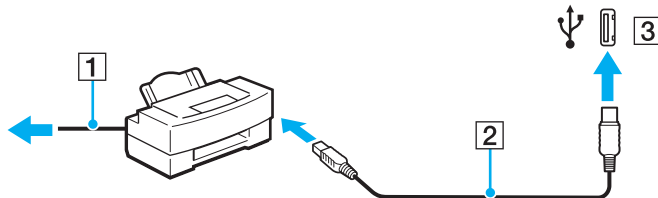

Connecting an i.LINK Device

Notes on connecting i.LINK devices

- ❑ Your computer is equipped with an i.LINK port, which you can use to connect to an i.LINK device such as a digital video camcorder.
- ❑ The i.LINK port on your computer does not supply power to external devices generally powered by i.LINK ports.
- ❑ The i.LINK port supports transfer rates up to 400 Mbps; however, the actual transfer rate depends on the transfer rate of the external device.
- ❑ The optional i.LINK cables may not be available in some countries or areas.
- ❑ An i.LINK connection with other compatible devices is not fully guaranteed.
- ❑ The i.LINK connection varies depending on the software applications, operating system, and i.LINK-compatible devices you use. See the manual that came with your software for more information.
- ❑ Check the working conditions and operating system compatibility of i.LINK-compatible PC peripherals (for example, an HDD or a CD-RW drive) before you connect them to your computer.

Connecting a Digital Video Camcorder



The i.LINK port is located behind the front panel door. You need to open this door before accessing the port.

To connect a digital video camcorder

Plug one end of an i.LINK cable (1) into the i.LINK port (2) on the computer and the other end into the DV In/Out port (3) on the digital video camcorder.

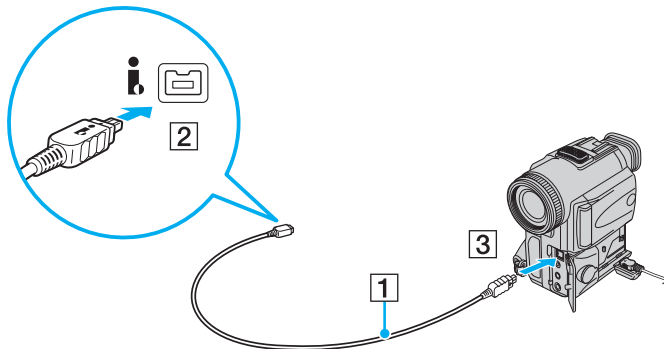

On Sony digital video cameras, ports labeled **DV Out**, **DV In/Out**, or **i.LINK** are i.LINK-compatible.

The Sony digital video camcorder shown here is an example; your digital video camcorder may need to be connected differently.

You cannot access the pictures stored on a Memory Stick media when using an i.LINK connection.

Connecting to a Network (LAN)

You can connect your computer to 100BASE-TX/10BASE-T-type networks with an Ethernet network cable. Connect one end of a network cable (not supplied) to the network (Ethernet) port on the back of the computer and the other end to your network. For detailed settings and devices needed to connect to the network, ask your network administrator.

!

Your computer has a protective sticker  covering the network (Ethernet) port located on its back. Connect a 10BASE-T or 100BASE-TX cable to the network (Ethernet) port. Using an incorrect cable, such as a phone cable, may result in an electric current overload that can cause a malfunction, excessive heat, or fire in the network (Ethernet) port. For help on connecting to a network, ask your network administrator.

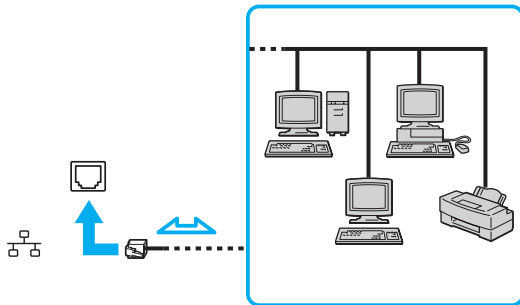

Your computer can be connected to the network with the default settings.

! Telephone lines cannot be connected to the network (LAN) connector on your computer. If the network (LAN) connector is connected to the telephone lines mentioned below, high electric current to the connector may cause damage, overheating, or fire.

- Home (intercom speakerphone) or business-use telephone lines (multi-line business telephone)
- Public telephone subscriber line
- PBX (private branch exchange)

Do not plug a telephone cable into the network port.

Customizing Your VAIO Computer

This section briefly describes how to change the main settings of your VAIO computer. Among other things, you will learn how to use and customize the look of your Sony software and utilities, etc.

- ❑ **Setting the Password** ([page 86](#))
- ❑ **Setting Up Your Computer with VAIO Control Center** ([page 89](#))
- ❑ **Using the Power Saving Mode** ([page 90](#))

Setting the Password

Use one of the BIOS functions to set the password.

Once you have set the password, you will be prompted to enter the password after the VAIO logo appears to start your computer. The power-on password allows you to protect your computer from unauthorized access.

Adding the Power-on Password

The power-on password is provided to protect your computer from unauthorized access.

! Once you have set the power-on password, you cannot start your computer without entering the password. Make sure not to forget the password. Write down your password and keep it safe and private from other people.

If you forget the power-on password and need assistance to reset it, a password reset fee will be charged, and your computer may need to be sent in for depot service for password reset.

To add the power-on password

- 1 Turn on the computer.
- 2 Press the **F2** key when the VAIO logo appears.
The BIOS setup screen appears. If not, restart the computer and press the **F2** key several times when the VAIO logo appears.
- 3 Press the **←** or **→** key to select **Security** to display the **Security** tab, select **Set Machine Password**, and then press the **Enter** key.
- 4 On the password entry screen, enter the password twice and press the **Enter** key.
The password can be up to 32 alphanumeric characters (including spaces) long.
- 5 At the confirmation prompt, press the **Enter** key.



The following is to configure your computer to prompt password entry when you turn it on or display the BIOS setup screen.

- 6 Select **Password when Power On** under **Security**.
Press the space bar to change the setting from **Disabled** to **Enabled**.
- 7 Press the **←** or **→** key to select **Exit**, select **Exit Setup**, and then press the **Enter** key.
At the confirmation prompt, press the **Enter** key.

Changing/Removing the Power-on Password

To change or remove the power-on password

- 1 Turn on the computer.
- 2 Press the **F2** key when the VAIO logo appears.
The BIOS setup screen appears. If not, restart the computer and press the **F2** key several times when the VAIO logo appears.
- 3 Enter the current password and press the **Enter** key.
- 4 Press the **←** or **→** key to select **Security** to display the **Security** tab, select **Set Machine Password**, and then press the **Enter** key.
- 5 On the password entry screen, enter the current password once and a new password twice, and then press the **Enter** key.
To remove the password, leave the **Enter New Password** and **Confirm New Password** fields blank and press the **Enter** key.
When confirmation to save the changes is prompted, press the **Enter** key.
- 6 Press the **←** or **→** key to select **Exit**, select **Exit Setup**, and then press the **Enter** key.
At the confirmation prompt, press the **Enter** key.

Setting Up Your Computer with VAIO Control Center

The **VAIO Control Center** utility allows you to access system information and to specify preferences for system behavior.

To use VAIO Control Center

- 1 Click **Start**, **All Programs**, and **VAIO Control Center**.
The **VAIO Control Center** window appears.
- 2 Select the desired control item and change the settings.
- 3 Once finished, click **OK**.
The setting of the desired item has been changed.



For more information about each option, see the help file on **VAIO Control Center**.

Some of the control items will not be visible if you open **VAIO Control Center** as a standard user.

Using the Power Saving Mode

In addition to the normal operating mode, which allows you to turn off specific devices, your computer has a distinct power saving mode called Sleep mode.

Using Normal Mode

This is the normal state of the computer when it is in use. To save power while not working, you can turn off a specific device such as the connected display or the hard disk drive.

Using Sleep Mode

Sleep mode temporarily suspends the entire system operations for lower power consumption. The orange power light is on during this mode.

! Turn off your computer if you do not intend to use it for a long period of time.

To activate Sleep mode

Click **Start**, the arrow next to the **Lock** button, and **Sleep**.



When your computer is in Sleep mode, you cannot insert a disc.

Alternatively, you can slide the power switch on the wireless keyboard to **OFF** position, or press the sleep button on the keyboard or the remote commander to place your computer into Sleep mode.

To return to Normal mode

- Press the power button on your computer.
- Slide the power switch on the wireless keyboard to the **ON** position; or press the sleep button or the space bar on the wireless keyboard.
- Press the sleep button on the wireless keyboard or the remote commander.

! If you press and hold the power button for more than four seconds, your computer will turn off automatically. You will lose all unsaved data.

If the computer is not used for a certain period of time, it will enter Sleep mode. To modify this, you can change the Sleep mode settings.

To change the Sleep mode settings

- 1 Right-click the power status icon on the taskbar and select **Power Options**.
- 2 Click **Change plan settings** under the current power plan.
- 3 Change the time to put the computer to sleep and click **Save Changes**.

Upgrading Your VAIO Computer

Your VAIO computer and memory modules use high precision components and electronic connectors technology. To avoid invalidation of the warranty during your product warranty period, we recommend that:

- You should contact your dealer to install a new component.
- You should not install it yourself, if you are not familiar with upgrading a computer.
- You should not touch the connectors on any component.

For the type of components available for upgrading and the amount of memory installed on your model, see the online **Specifications**.

Contact VAIO-Link if you need assistance.

Adding and Removing Memory

If you want to expand the functionality of your computer, you can increase the memory by installing optional memory modules. Before you upgrade your computer's memory, read the notes and procedures in this section.

Notes on adding/removing memory modules

- ❑ Be careful when changing memory. Improper installation of memory modules may cause damage to your system. This damage may void your manufacturer's warranty.
- ❑ Only use memory modules that are compatible with your computer. If a memory module is not detected by the computer or the Windows operating system becomes unstable, contact your sales dealer or the manufacturer of your memory module.
- ❑ Electrostatic discharge (ESD) can damage electronic components. Before touching a memory module, ensure the following:
 - ❑ The procedures described in this document assume user familiarity with the general terminology associated with personal computers and with the safety practice and regulatory compliance requirements for using and modifying electronic equipment.
 - ❑ Turn off your computer and disconnect it from its power source (that is, AC adapter) and from any telecommunication links, networks, or modems before you remove any cover or panel from the computer. Failure to do so may result in personal injury or equipment damage.
 - ❑ ESD can damage memory modules and other components. Install the memory module only at an ESD workstation. If such a station is not available, do not work in a carpeted area, and do not handle materials that produce or hold static electricity (cellophane wrappers, for example). Ground yourself by maintaining contact with an unpainted metal portion of the chassis while performing the procedure.
 - ❑ Do not open the memory module package before you are ready to change the module. The package protects the module from ESD.

- ❑ Use the special bag delivered with the memory module or wrap the module in aluminum foil to protect it from ESD.
- ❑ Introducing any liquids, foreign substances, or objects into the memory module slots or other internal components of your computer will result in damage to the computer and any repair costs will not be covered by the warranty.
- ❑ Do not place the memory module in a location subject to:
 - ❑ Heat sources such as radiators or air ducts
 - ❑ Direct sunlight
 - ❑ Excessive dust
 - ❑ Mechanical vibration or shock
 - ❑ Strong magnets or speakers that are not magnetically shielded
 - ❑ Ambient temperature of more than 35°C or less than 5°C
 - ❑ High humidity
- ❑ Handle the memory module with care. To avoid injuries to your hands and fingers, do not touch the edges of the components and circuit boards inside your computer.

Removing and Installing a Memory Module

To change or add a memory module

- 1 Shut down the computer and disconnect all peripheral devices.
- 2 Unplug the computer and wait until the computer cools down.
- 3 Unscrew the screws (indicated by the arrows below) on the bottom of the computer and remove the memory module compartment cover.

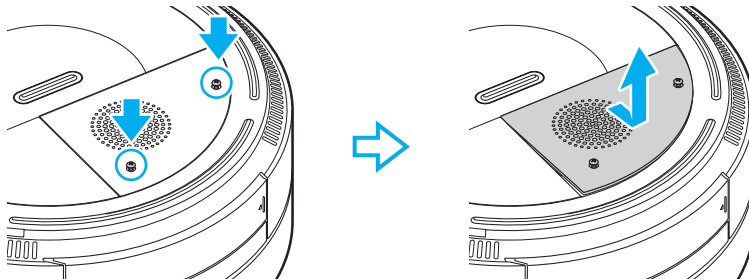

! When placing your computer upside down, be sure to put the computer on a soft cloth to protect it from scratches.

- 4 Touch a metal object to discharge static electricity.

5 Remove the currently installed memory module as follows:

- ❑ Pull the latches in the direction of the arrows (1).
The memory module is released.
- ❑ Make sure that the memory module tilts up and then pull it out in the direction of the arrow (2).

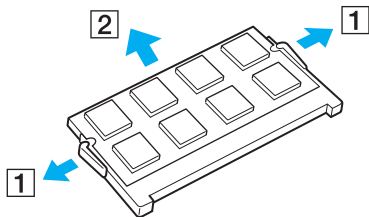

6 Remove the new memory module from its packaging.

- 7 Slide the memory module into the memory module slot and push it in until it clicks into place.

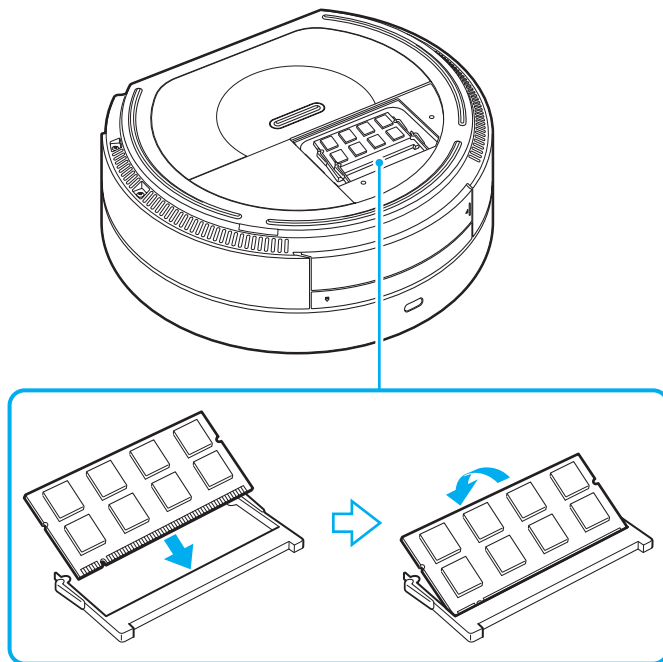

! Do not touch any other components on the motherboard.

Be sure to insert the connector edge of the memory module into the slot while aligning the notch on the module with the small projection in the open slot.

- 8 Replace the memory module compartment cover and tighten the screws on the bottom of the computer.

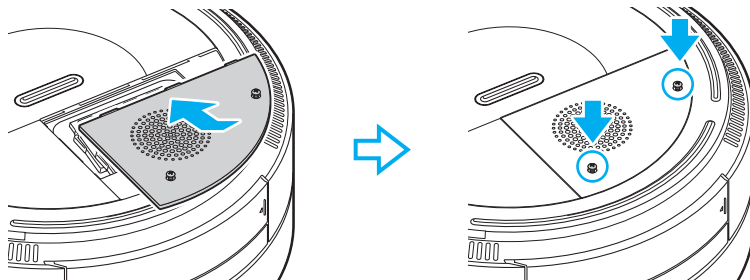

- 9 Connect a power source and turn on the computer.

Viewing the Amount of Memory

To view the amount of memory

- 1 Turn on the computer.
- 2 Click **Start**, **All Programs**, and **VAIO Control Center**.
- 3 Double-click the **System Information** folder in the **VAIO Control Center** window.
- 4 Double-click the **System Information** icon in the **System Information** folder.
You can view the amount of system memory. If the additional memory does not appear, repeat the whole installation procedure and restart the computer.

Precautions

This section describes safety guidelines and precautions to help you protect your VAIO computer from potential damage.

- ❑ **On Using the Power Source** ([page 102](#))
- ❑ **On Handling Your Computer** ([page 103](#))
- ❑ **On Handling Floppy Disks** ([page 106](#))
- ❑ **On Handling Discs** ([page 107](#))
- ❑ **On Using Headphones** ([page 108](#))
- ❑ **On Handling Memory Stick Media** ([page 109](#))
- ❑ **On Handling the Hard Disk** ([page 110](#))
- ❑ **On Updating Your Computer** ([page 111](#))

On Using the Power Source

- ❑ See the online **Specifications** to check the power operation of your model.
- ❑ Do not share the AC outlet with other power-consuming equipment, such as a photocopier or a shredder.
- ❑ You can purchase a power strip with a surge protector. This device helps prevent damage to your computer caused by sudden power surges, in an electrical storm, for example.
- ❑ Do not place heavy objects on the power cord.
- ❑ To disconnect the cord, pull it out by holding the plug. Never pull the cord itself.
- ❑ Unplug your computer from the AC outlet if you are not planning to use the computer for a long period of time.
- ❑ Make sure that the AC outlet is easily accessible.
- ❑ Use the AC adapter supplied with your computer or genuine Sony products. Do not use any other AC adapter as it may cause a malfunction.

On Handling Your Computer

- ❑ Clean the cabinet with a soft cloth, which is dry or lightly moistened with a mild detergent solution. Do not use any type of abrasive pad, scouring powder, or solvent such as alcohol or benzene, as these may damage the finish of your computer.
- ❑ If you drop a solid object or any liquid onto your computer, shut down the computer and then unplug it. You may want to have the computer checked by qualified personnel before operating it again.
- ❑ Do not drop your computer.
- ❑ Do not place your computer in a location subject to:
 - ❑ Heat sources, such as radiators or air ducts
 - ❑ Direct sunlight
 - ❑ Excessive dust
 - ❑ Moisture or rain
 - ❑ Mechanical vibration or shock
 - ❑ Strong magnets or speakers that are not magnetically shielded
 - ❑ Ambient temperature of more than 35°C or less than 5°C
 - ❑ High humidity
- ❑ Do not place electronic equipment near your computer. The electromagnetic field of the computer may cause a malfunction.
- ❑ Do not place any objects on top of your computer as it may cause:
 - ❑ Degradation in performance of the computer
 - ❑ Discolorations on the surface of the computer
 - ❑ Physical injuries if an object falls; or falls off the computer and breaks

- ❑ Be sure to place your computer in the flat position as it is not designed for upright placement.
- ❑ Provide adequate air circulation to prevent internal heat from building up. The internal heat will cause your computer to malfunction.
 - ❑ Do not place your computer on porous surfaces such as rugs or blankets, or near material such as curtains or draperies that may block its air vents.
 - ❑ Be sure to allow clearance of at least 5 cm wide on either side (1) of your computer.
 - ❑ Keep the front (2) and back (3) of your computer unblocked.

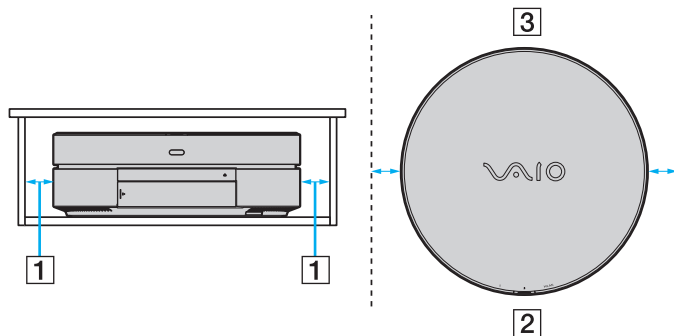

- ❑ When holding your computer, be sure to wait until it cools down. The back of your computer may be extremely hot around the air exhaust vent.
- ❑ Your computer uses high-frequency radio signals and may cause interference to radio or TV reception. If this occurs, relocate the computer a suitable distance away from the set.
- ❑ Use only specified peripheral equipment and interface cables; otherwise, problems may occur.
- ❑ Do not use cut or damaged connection cables.

- ❑ If your computer is brought directly from a cold location to a warm one, moisture may condense inside the computer. In this case, allow at least one hour before turning on the computer. If any problems occur, unplug the computer and contact VAIO-Link.
- ❑ Make sure you disconnect the power cord before cleaning your computer.
- ❑ To avoid losing data if your computer is damaged, back up your data regularly.

On Handling Floppy Disks

- ❑ Do not open the shutter manually or touch the surface of the floppy disk.
- ❑ Keep floppy disks away from magnets.
- ❑ Keep floppy disks away from direct sunlight and other sources of heat.
- ❑ Keep floppy disks away from any liquid. Do not let them get wet. When you are not using your floppy disk, always remove it from the floppy disk drive and use a storage case.
- ❑ If the floppy disk comes with an adhesive label, make sure that the label is properly affixed. If the edge of the label is curled up, the label may stick to the inside of the floppy disk drive and cause a malfunction or damage your floppy disk.

On Handling Discs

- ❑ Do not touch the surface of the disc.
- ❑ Do not drop or bend the disc.
- ❑ Fingerprints and dust on the surface of a disc may cause read errors. Always hold the disc by its edges and central hole, as shown below:

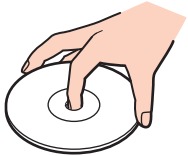

- ❑ Proper care of the disc is essential to its continuous reliability. Do not use solvents (such as benzene, thinner, alcohol, commercially available cleaners, or anti-static spray) which may cause damage to the disc.
- ❑ For normal cleaning, hold the disc by its edge and use a soft cloth to wipe the surface from the center out.
- ❑ If the disc is badly soiled, moisten a soft cloth with water, wring it out well, and use it to wipe the surface of the disc from the center out. Wipe off any remaining moisture with a dry soft cloth.
- ❑ Never affix an adhesive label to a disc. This will affect the use of the disc irreparably.

On Using Headphones

Preventing hearing damage – Avoid using headphones at high volume. Hearing experts advise against continuous, loud and extended play. If you experience a ringing in your ears, reduce the volume or discontinue use.

On Handling Memory Stick Media

- ❑ Do not touch the Memory Stick media connector with your finger or metallic objects.
- ❑ Use only the adhesive label supplied with the Memory Stick media as a label.
- ❑ Do not bend, drop, or apply strong shock to the Memory Stick media.
- ❑ Do not disassemble or modify Memory Stick media.
- ❑ Do not let Memory Stick media get wet.
- ❑ Do not use or store Memory Stick media in a location subject to:
 - ❑ Static electricity
 - ❑ Electrical noise
 - ❑ Extremely high temperatures, such as in a car parked in the sun
 - ❑ Direct sunlight
 - ❑ High humidity
 - ❑ Corrosive substances
- ❑ Use the storage case supplied with the Memory Stick media.
- ❑ Be sure to make a backup copy of your valuable data.
- ❑ Keep the Memory Stick media and Memory Stick Adaptors out of reach of children. There is a risk of swallowing them.
- ❑ When using the Memory Stick Duo media, do not use a fine-tipped pen to write on the label adhered to the Memory Stick Duo media. Exerting pressure on the media may damage internal components.

On Handling the Hard Disk

The hard disk drive has a high storage density and reads or writes data in a short time. However, it can be easily damaged by mechanical vibration, shock, or dust.

Although the hard disk drive has the internal safety device to prevent losing data due to mechanical vibration, shock or dust, you should be careful when handling your computer.

To avoid damaging your hard disk drive

- Do not subject your computer to sudden movements.
- Keep your computer away from magnets.
- Do not place your computer in a location subject to mechanical vibration or in an unstable position.
- Do not move your computer while the power is on.
- Do not turn off the power or restart your computer while reading or writing data to the hard disk drive.
- Do not use your computer in a place subject to extreme changes in temperature.



If the hard disk drive is damaged, the data cannot be restored.

On Updating Your Computer

Confirm that the latest updates have been installed on your computer using the following software applications so that the computer can run more efficiently.

To confirm that they have been installed on the computer, follow these steps for each software application:

Windows Update

Click **Start**, **All Programs**, and **Windows Update** and then follow the on-screen instructions.

VAIO Update 3

Click **Start**, **All Programs**, **VAIO Update 3**, and **VAIO Update Options** and then follow the on-screen instructions.

If you have not yet installed the latest updates, install them with the above software. To download and install the updates on the computer, the computer must be connected to the Internet. For information on how to connect the computer to the Internet, see **Using the Internet** ([page 63](#)).

Troubleshooting

This section describes how to solve common problems you might encounter when using your VAIO computer. Many problems have simple solutions. Try these suggestions before contacting VAIO-Link.

- ❑ **Computer** ([page 113](#))
- ❑ **System Security** ([page 119](#))
- ❑ **Networking** ([page 120](#))
- ❑ **Optical Discs** ([page 123](#))
- ❑ **Display** ([page 127](#))
- ❑ **Printing** ([page 130](#))
- ❑ **Microphone** ([page 131](#))
- ❑ **Speakers** ([page 132](#))
- ❑ **Keyboard** ([page 133](#))
- ❑ **Touch Pad** ([page 134](#))
- ❑ **Floppy Disks** ([page 135](#))
- ❑ **Audio/Video** ([page 136](#))
- ❑ **Memory Stick Media** ([page 138](#))
- ❑ **Peripherals** ([page 139](#))

Computer

What should I do if my computer does not start?

- ❑ Make sure your computer is securely plugged into a power source and turned on. Make sure the power indicator shows the power is on.
- ❑ Make sure the floppy disk drive (if applicable) is empty.
- ❑ If your computer is plugged into a power strip or an uninterruptible power supply (UPS), make sure the power strip or UPS is plugged into a power source and turned on.
- ❑ Make sure your external display is plugged into an appropriate power source and turned on.
- ❑ Make sure the brightness and contrast controls on your external display are adjusted correctly.
- ❑ Disconnect the AC adapter. Wait three to five minutes. Reattach the AC adapter and press the power button to turn on your computer.
- ❑ Condensation may cause your computer to malfunction. If this occurs, do not use the computer for at least one hour.
- ❑ Remove any extra memory modules you may have installed since purchase.
- ❑ Check that you are using the supplied Sony AC adapter. For your safety, use only the genuine Sony AC adapter, which is supplied by Sony for your VAIO computer.
- ❑ Make sure your computer is not in Sleep mode by pressing the power button on the computer or the sleep button on the wireless keyboard or the remote commander. If you press and hold the power button for more than four seconds, your computer will turn off automatically.

What should I do if a BIOS error appears when I turn on my computer?

If the message "Press <F1> to resume, <F2> to setup" appears at the bottom of the screen, follow these steps:

- 1** Press the **F2** key.
The BIOS setup screen appears. If not, restart the computer and press the **F2** key several times when the VAIO logo appears.
- 2** Set the date (month/day/year). Press the **Enter** key.
- 3** Press the **↓** key to select **System Time**, and then set the time (hour: minute: second). Press the **Enter** key.
- 4** Press the **→** key to select the **Exit** tab, and then press the **F9** key.
At the confirmation prompt, press the **Enter** key.
- 5** Select **Exit Setup**, and press the **Enter** key.
At the confirmation prompt, press the **Enter** key.
Your computer restarts.

If this occurs frequently, contact VAIO-Link.

What should I do if the power indicator lights but my screen stays blank?

- ❑ Make sure the proper input for your display (VGA, DVI-D monitor) is selected.
- ❑ Make sure your display (VGA, DVI-D monitor) is turned on.
- ❑ If your display is still blank, follow these steps:
 - 1 Press the power button on your computer for more than four seconds to check that the power indicator goes out. Then turn on your computer again.
 - 2 If your display still stays blank, unplug the power cord and leave the computer for about a minute. Then plug in the power cord and turn on the computer again.

! Turning off your computer with the power button may cause loss of unsaved data.

What should I do if my computer or software stops responding?

- ❑ If your computer stops responding while a software application is running, press the **Alt+F4** keys to close the application window.
- ❑ If the **Alt+F4** keys do not work, click **Start**, the arrow next to the **Lock** button, and **Shut Down** to turn off your computer.
- ❑ If your computer does not turn off, press the **Ctrl+Alt+Delete** keys and click the arrow  next to the **Shut down** button and **Shut Down**.
If the **Windows Security** window appears, click **Shut Down**.

!
Turning off your computer with the **Ctrl+Alt+Delete** keys or the power button may cause loss of unsaved data.

- ❑ If your computer still does not turn off, press and hold the power button until the computer turns off.
- ❑ Remove the AC adapter.
- ❑ Try reinstalling the software.
- ❑ Contact the software publisher or designated provider for technical support.

Why doesn't my computer enter Sleep mode?

Your computer may become unstable if the operating mode is changed before the computer completely enters Sleep mode.

To restore your computer to normal operating stability

- 1 Close all open programs.
- 2 Click **Start**, the arrow next to the **Lock** button, and **Restart**.
- 3 If your computer does not restart, press the **Ctrl+Alt+Delete** keys and click the arrow next to the **Shut down** button and **Restart**.
- 4 If this procedure does not work, press and hold the power button until the computer turns off.

! Turning off your computer with the power button may cause loss of unsaved data.

What should I do if Windows does not start, showing a message, when I start my computer?

- Make sure your computer does not have a "non-bootable" disc in the optical disc drive.
- If a non-bootable disc is in the drive, follow these steps:
 - 1 Remove the disc.
 - 2 Restart your computer and confirm that the Windows operating system launches properly.
- If you enter a wrong power-on password three times consecutively, the **Enter Onetime Password** message appears and Windows will not start. Press and hold the power button for more than four seconds to check that the VAIO power indicator goes off. Wait for 10 or 15 seconds, then restart your computer and enter the correct password. When entering the password, check that the Num Lock indicator and Caps Lock indicator on the wireless keyboard are off. If any are lit, press the **Num Lock** key or the **Caps Lock** key to turn off the indicator before entering the password.

What should I do if my game software does not work or it keeps crashing?

- Check the Web site of the game if there are any patches or updates to download.
- Make sure you have installed the latest video driver.
- On some VAIO models, the graphics memory is shared with the system. The optimal graphic performance in this case is not guaranteed.

What should I do if I cannot remember the BIOS password?

If you have forgotten the BIOS password, contact VAIO-Link to reset it. A reset fee will be charged.

Why does it take time before my computer starts?

If Norton Internet Security's Personal Firewall is active, it may take some time before the desktop screen appears due to network security checkups.

Why doesn't my screen turn off when the time selected for the automatic turn-off action has passed?

The **VAIO Original Screen Saver** disables the timer setting, which you can select using the Windows power options, for your screen to turn off.

Select the screen saver other than the **VAIO Original Screen Saver**.

System Security

How can I protect my computer against security threats, such as viruses?

The Microsoft Windows operating system is preinstalled on your computer. The best way to protect your computer against security threats, such as viruses, is to download and install the latest Windows updates regularly.

You can get important Windows updates by doing the following:



Your computer must be connected to the Internet before you can receive updates.

- 1 Connect to the Internet.
- 2 Double-click the **Windows Security Alerts** icon on the taskbar.
- 3 Follow the on-screen instructions to set up automatic or scheduled updates.

How do I keep my antivirus software updated?

You can keep the **Norton Internet Security** software program current with the latest updates from Symantec Corporation.

To download and install the latest security update

- 1 Click **Start, All Programs, Norton Internet Security, and Norton Internet Security**.
- 2 Click the item to update the software on the left pane.
- 3 Follow the on-screen instructions to select and download updates.

Networking

What should I do if my computer cannot connect to a wireless LAN access point?

- Connection availability is affected by distance and obstructions. You may need to move your computer away from obstructions or closer to any access point you may be using.
- Make sure the **WLAN** switch is on and the Wireless LAN indicator is lit on your computer.
- Make sure power to the access point is on.
- Follow these steps to check the settings:
 - 1 Click **Start** and **Control Panel**.
 - 2 Click **View network status and tasks** under **Network and Internet**.
 - 3 Click **Connect to a network** to confirm that your access point is selected.
- Make sure the encryption key is correct.

What should I do if I cannot access the Internet?

- Check the access point settings. See the manual that came with your access point for more information.
- Make sure your computer and the access point are connected to one another.
- Move your computer away from obstructions or closer to any access point you may be using.
- Make sure your computer is properly configured for Internet access.

Why is the data transfer speed slow?

- ❑ The wireless LAN data transfer speed is affected by distance and obstructions between devices and access points. Other factors include device configurations, radio conditions, and software compatibility. To maximize the data transfer speed, move your computer away from obstructions or closer to any access point you may be using.
- ❑ If you are using a wireless LAN access point, the device may be temporarily overloaded depending on how many other devices are communicating via the access point.
- ❑ If your access point interferes with other access points, change the access point channel. See the manual that came with your access point for more information.

How do I avoid data transfer interruptions?

- ❑ When your computer is connected to an access point, data transfer interruptions may occur when using large files or if the computer is in close proximity to microwaves and cordless telephones.
- ❑ Move your computer closer to the access point.
- ❑ Make sure the access point connection is intact.
- ❑ Change the access point channel. See the manual that came with your access point for more information.

What are channels?

- ❑ Wireless LAN communication occurs on divided frequency bands known as channels. Third-party wireless LAN access point channels may be preset to different channels from Sony devices.
- ❑ If you are using a wireless LAN access point, see connectivity information contained in the manual that came with your access point.

Why does the network connection stop when I change the encryption key?

Two computers with the wireless LAN functionality may lose a peer-to-peer network connection if the encryption key is changed. You can either change the encryption key back to the original profile or re-enter the key on both computers so the key matches.

Optical Discs

Why does my computer freeze when I try to read a disc?

The disc that your computer is trying to read may be dirty or damaged. Follow these steps:

- 1 Press the **Ctrl+Alt+Delete** keys and click the arrow next to the **Shut down** button and **Restart** to restart the computer.
- 2 Remove the disc from the optical disc drive.
- 3 Check the disc for dirt or damage. If you need to clean the disc, see **On Handling Discs (page 107)** for instructions.

What should I do if the drive tray does not open?

- Make sure your computer is on.
- Push in the optical disc drive tray.
- If this does not work, click **Start** and **Computer**. Right-click the optical disc drive icon and select **Eject**.
- If none of the above options work, insert a thin, straight object (such as a paper clip) in the manual eject hole on the optical disc drive.
- Try restarting your computer.

What should I do if I cannot play a disc properly on my computer?

- ❑ Make sure the disc is inserted into the optical disc drive with the label facing upward.
- ❑ Make sure the necessary program(s) is installed according to the manufacturer's instructions.
- ❑ If a disc is dirty or damaged, your computer will stop responding. Follow these steps:
 - 1 Press the **Ctrl+Alt+Delete** keys and click the arrow next to the **Shut down** button and **Restart** to restart the computer.
 - 2 Remove the disc from the optical disc drive.
 - 3 Check the disc for dirt or damage. If you need to clean the disc, see **On Handling Discs (page 107)** for instructions.
- ❑ If you are playing a disc and cannot hear sound, do any of the following:
 - ❑ Check if the volume is turned off or minimized by the muting or volume button, respectively, on the remote commander.
 - ❑ Right-click the volume icon on the taskbar and click **Open Volume Mixer** to check the settings.
 - ❑ Check the volume setting in the audio mixer.
 - ❑ If you are using external speakers, check the volume settings on the speakers and the connections between the speakers and your computer.
 - ❑ Make sure the correct driver software is installed. Follow these steps:
 - 1 Click **Start** and **Control Panel**.
 - 2 Click **System and Maintenance**.
 - 3 Click **System**.
 - 4 Click **Device Manager** on the left pane.

The **Device Manager** window appears with a listing of your computer's hardware devices.
If an "X" or an exclamation point appears on the listed device, you may need to enable the device or reinstall the drivers.
 - 5 Double-click the optical disc drive device to open a list of the optical disc drives of your computer.

6 Double-click the desired drive.

You can confirm the driver software by selecting the **Driver** tab, and clicking **Driver Details**.

7 Click **OK** to close the window.

- ❑ Make sure an adhesive label is not affixed to a disc. Adhesive labels can come off while the disc is in the optical disc drive and damage the drive or cause it to malfunction.
- ❑ If a region code warning appears, the disc may be incompatible with the optical disc drive. Check the DVD package to make sure the region code is compatible with the optical disc drive.
- ❑ If you notice condensation on your computer, do not use the computer for at least one hour. Condensation can cause the computer to malfunction.

What should I do if I cannot write data to CD media?

- ❑ Make sure you neither launch any software application nor allow any to launch automatically, not even a screen saver.
- ❑ Stop using the keyboard.
- ❑ If you are using a CD-R/RW disc with an adhesive label affixed, replace it with one with no affixed adhesive label. Using a disc with an affixed adhesive label could cause a write error or other damage.

What should I do if I cannot write data to DVD media?

- ❑ Make sure you are using the correct DVD recordable media.
- ❑ Check which DVD recordable format is compatible with your optical disc drive. Note the possibility that some brands of DVD recordable media do not work.
- ❑ The preinstalled software on your computer does not support copying DVD movies. Macrovision or a similar video protection technology prevents users from copying DVD movies. Copying a DVD movie would be a copyright infringement and therefore illegal.

Display

What should I do if my TV screen stays blank?

- Make sure that both power cords of your computer and TV are securely plugged into power sources.
- Make sure that your computer and TV are properly connected.
- Make sure that both your computer and TV are turned on.
- When two displays are connected to your computer, make sure that the display settings are correct on the other display. See **Selecting Display Modes** (page 74).

What should I do if my TV screen is dark?

- Adjust the brightness control on your TV to brighten the screen. See the manual that came with your TV for the detailed instructions.
- Check other inputs on your TV for brightness. If they also appear dark, see the manual that came with your TV for adjustment.

What should I do if my TV shows distorted images?

Make sure that your computer and TV are properly connected.

What should I do if the screen of my TV that is connected to the HDMI OUT port stays blank?

- ❑ Unplug the HDMI cable once and plug it back.
- ❑ Your TV may not be HDCP compliant. Be sure to use an HDCP compliant TV.
- ❑ When two displays are connected to your computer, make sure that the display settings are correct on the other display. See **Selecting Display Modes** ([page 74](#)).

What should I do if my TV does not show a clear view of the Windows desktop?

Depending on your TV, it may not be capable of displaying the Windows desktop as clearly as computer displays. You may solve this problem by disabling the image quality settings on your TV, such as noise reduction, correction features, and enhancer features; but it also depends on your TV if such changes to the settings are available. For more information, see the manual that came with your TV.

How do I run Windows Aero?

! This Q & A entry applies to selected models only.

To run Windows Aero, follow these steps:

- 1 Click **Start** and **Control Panel**.
- 2 Click **Customize colors** under **Appearance and Personalization**.
- 3 Click **Open classic appearance properties for more color options**.
The **Appearance Settings** window appears.
- 4 Select **Windows Aero** from the **Color scheme** options on the **Appearance** tab.
- 5 Click **OK**.

For information about the Windows Aero features, such as Windows Flip 3D, see **Windows Help and Support**.

Printing

What should I do if I cannot print a document?

- ❑ Make sure your printer is on, and the printer cable is securely connected to the ports on the printer and computer.
- ❑ Make sure your printer is compatible with the Windows operating system installed on your computer.
- ❑ You may need to install the printer driver software before you use your printer. See the manual that came with your printer for more information.
- ❑ If your printer is not functioning after your computer resumes from Sleep mode, then restart the computer.
- ❑ If the bidirectional communication functions are provided with your printer, disabling the functions on your computer may enable printing. Follow these steps:
 - 1 Click **Start** and **Control Panel**.
 - 2 Click **Printer** under **Hardware and Sound**.
 - 3 Right-click the printer icon and select **Properties**.
 - 4 Click the **Ports** tab.
 - 5 Click to cancel the **Enable bidirectional support** check box.
 - 6 Click **OK**.

This change to the settings disables the bidirectional communication functions of the printer, such as data transfer, status monitoring, and remote panel.

Microphone

What should I do if my microphone does not work?

Make sure your external microphone is turned on and is properly plugged into the microphone jack on your computer.

How can I prevent microphone feedback?

Microphone feedback occurs when the microphone receives the sound from a sound output device, such as a speaker.

To prevent this problem:

- Keep the microphone away from a sound output device.
- Turn down the volume of the speakers and the microphone.

Speakers

What should I do if my external speakers do not work?

- ❑ If you are using a program that has its own volume control, make sure the volume control is properly set. See the program's help file for more information.
- ❑ Make sure your speakers are properly connected and the volume is turned up loud enough to hear sound.
- ❑ Make sure your speakers are designed for computer use.
- ❑ If your speakers have a muting button, set the button to off.
- ❑ The volume may have been turned off by the muting button. Press the button once again.
- ❑ The volume may have been turned off by one of the volume control buttons on the remote commander. Press the other to turn up the volume loud enough to hear sound.
- ❑ If your speakers require external power, make sure the speakers are connected to a power source. See the manual that came with your speakers for more information.
- ❑ Check the Windows volume controls by clicking the volume icon on the taskbar.

Keyboard

What should I do if the keyboard configuration is wrong?

The language layout of your wireless keyboard is labeled on the packaging box. If you choose a different regional keyboard when you complete the Windows setup, the key configuration will be mismatched.

To change the keyboard configuration, follow these steps:

- 1 Click **Start** and **Control Panel**
- 2 Click **Clock, Language, and Region**, and click **Regional and Language Options**.
- 3 Change the settings as desired.

What should I do if I cannot enter certain characters with the keyboard?

- If you cannot enter **U, I, O, P, J, K, L, M**, and so on, the **Num Lk** key may be activated. Check that the Num lock indicator is off. If the Num lock indicator is on, press the **Num Lk** key to turn it off before entering these characters.
- Avoid using any wireless devices that exchange radio signals on the 2.4 GHz frequency band near the wireless keyboard. These devices may cause interference, causing the keyboard to stop working properly.
- Do not place metal furniture near your computer or wireless keyboard, as this may create interference, causing the keyboard to stop working properly.

What should I do if my computer does not recognize my keyboard?

- Make sure the power switch on the wireless keyboard is in the **ON** position.
- Make sure the supplied AA batteries are properly installed.
- Press the **CONNECT** button on your computer and then on the wireless keyboard to re-establish the connection between the two devices.

Touch Pad

What should I do if the touch pad does not work?

- ❑ Make sure that a mouse is not connected to your computer.
- ❑ If the pointer does not move while a software application is running, press the **Alt+F4** keys to close the application window.
- ❑ If the **Alt+F4** keys do not work, click **Start**, the arrow next to the **Lock** button, and **Restart** to restart your computer.
- ❑ If your computer does not restart, press the **Ctrl+Alt+Delete** keys and click the arrow next to the **Shut down** button and **Restart**.
If the **Windows Security** window appears, click **Restart**.
- ❑ If this procedure does not work, press and hold the power button until the computer turns off.



Turning off your computer with the power button may cause loss of unsaved data.

Floppy Disks

Why doesn't the Safely Remove Hardware icon appear on the taskbar when the drive is connected?

Your computer does not recognize the floppy disk drive. First, make sure the USB cable is properly connected to the USB port. If you need to secure the connection, wait a few moments for the computer to recognize the drive. If the icon still does not appear, follow these steps:

- 1 Close all programs that are accessing the floppy disk drive.
- 2 Wait for the LED indicator on the floppy disk drive to turn off.
- 3 Push the eject button to remove the disk, and disconnect the USB floppy disk drive from your computer.
- 4 Reconnect the floppy disk drive by inserting the USB connector into the USB port.
- 5 Restart the computer by clicking **Start**, the arrow next to the **Lock** button, and **Restart**.

What should I do if I cannot write data to a floppy disk?

- Make sure the floppy disk is properly inserted in the drive.
- If the disk is inserted properly and you are still unable to write data to it, the disk may be full or write-protected. You can either use a floppy disk that is not write-protected or disable the write-protect feature.

Audio/Video

What should I do if I cannot use my DV camcorder?

If it is prompted that the i.LINK device seems to be disconnected or turned off, the i.LINK cable may not be securely plugged into the port on your computer or camcorder. Unplug the cable, and plug it in once again. See **Connecting an i.LINK Device (page 81)** for more information.



i.LINK is a trademark of Sony used only to designate that a product contains an IEEE 1394 connection. The procedure to establish an i.LINK connection may vary, depending on a software application, an operating system, and a compatible i.LINK device. Not all products with an i.LINK connection can communicate with each other. See the manual that came with your compatible i.LINK device for more information on operating conditions and proper connection. Before connecting compatible i.LINK PC peripherals to your system, such as a CD-RW or hard disk drive, confirm their operating system compatibility and required operating conditions.

How do I turn off the Windows startup sound?

To turn off the Windows startup sound, follow these steps:

- 1 Click **Start** and **Control Panel**.
- 2 Click **Hardware and Sound**.
- 3 Click **Manage audio devices** under **Sound**.
- 4 On the **Sounds** tab, click to cancel the **Play Windows Startup sound** check box.
- 5 Click **OK**.

What should I do if I do not hear the sound from the sound output device connected to the HDMI OUT or OPTICAL OUT port?

- ❑ Once you have connected a device to the **HDMI OUT** or **OPTICAL OUT** port, you need to change the device for sound output if you want to hear sound from the device.

To change the sound output device, follow these steps:

- 1 Close all open programs.
 - 2 Click **Start** and **Control Panel**.
 - 3 Click **Hardware and Sound**.
 - 4 Click **Manage audio devices** under **Sound**.
 - 5 On the **Playback** tab, select the desired device for sound output and click **Set Default**.
- ❑ If you still hear no sound from the sound output device, follow these steps:
 - 1 Follow steps 1 to 4 above.
 - 2 On the **Playback** tab, select the HDMI or S/PDIF icon and click **Properties**.
 - 3 Click the **Advanced** tab.
 - 4 Select the sample rate and bit depth (for example, 48000 Hz, 16 bit) which the device supports.
 - 5 Click **OK**.

Memory Stick Media

What should I do if I cannot use Memory Stick media, which were formatted on a VAIO computer, on other devices?

You may need to reformat your Memory Stick media.

Formatting Memory Stick media erases all data, including music data previously saved on it. Before you reformat Memory Stick media, back up important data and confirm that the media does not contain files you want to keep.

- 1 Copy the data from the Memory Stick media onto your hard disk drive to save data or images.
- 2 Format the Memory Stick media by following the steps in **To format a Memory Stick media (page 56)**.

Why can't I save music files onto my Memory Stick media?

Copyright protected music cannot be checked out to any Memory Stick media other than those with the MagicGate logo.

! Use of recorded music requires permission from the copyright holders.

Sony is not responsible for music files that cannot be recorded from a CD or downloaded from other sources.

Can I copy images from a digital camera using Memory Stick media?

Yes, and you can view video clips that you have recorded with Memory Stick media-compatible digital cameras.

Why can't I write data to Memory Stick media?

Some versions of Memory Stick media are equipped with an erasure prevention switch to protect data from accidental erasure or overwriting. Make sure the erasure prevention switch is off.

Peripherals

What should I do if I cannot connect a USB device?

- ❑ If applicable, check the USB device is turned on and using its own power supply. For example, if you are using a digital camera, check if the battery is charged. If you are using a printer, check if the power cable is connected properly to the AC outlet.
- ❑ Try using another USB port on your computer. The driver could be installed to the specific port you used the first time you connected the device.
- ❑ See the manual that came with your USB device for more information. You may need to install software before you connect the device.
- ❑ Try connecting a simple, low-powered device such as a mouse to test if the port is working at all.
- ❑ USB hubs may prevent a device from working because of the distribution of power. We recommend you connect the device directly to your computer without a hub.

Support Options

This section contains information on where to go for answers to questions about your VAIO computer.

Sony Support Information

See the following sources for answers in the sequence listed below.

See **Documentation (page 6)** for details on the printed and non-printed documentation supplied with your computer, as well as further sources of reference.

- Go to the help files that accompany your software for instructions on using the software.
- Use the search functionality in **Windows Help and Support** by pressing and holding the Microsoft Windows key and pressing the **F1** key.
- VAIO-Link Web site:** If you have any problem with the computer, you can access the VAIO-Link Web site for troubleshooting. Go to <http://support.vaio.sony.eu>.
- e-Support:** This interactive part of our Web site <http://support.vaio.sony.eu> allows you to get in contact with our dedicated support team over the Internet. Using a personalized account, you can log your technical queries with ease.
- VAIO-Link help lines:** Before contacting VAIO-Link by telephone, try to solve the problem by reading the printed and non-printed documentation.
- Visit the other Sony Web sites:
 - <http://www.club-vaio.com> if you want to know more about VAIO and become part of the growing VAIO community.
 - <http://www.sonystyle-europe.com> for online purchases.
 - <http://www.sony.net> for other Sony products.



You need to set up an Internet connection before you can access the online features described here.

e-Support

What is e-Support?

You have searched our user guides and Web site (<http://support.vaio.sony.eu>) but have not found an answer to your question/issue? e-Support is the ideal solution for you!

Our e-Support Web Portal is an interactive Web site on which you can submit any technical query you may have regarding your computer and receive answers from our dedicated support team.

Every submitted query will result in a unique 'case number' to ensure smooth communication between yourself and the e-Support Team.

Who can use e-Support?

All registered VAIO customers are entitled to unlimited access to the VAIO-Link e-Support Web Portal.

How can I access the e-Support portal?

When you register your computer, you will automatically receive an e-mail with the link to the e-Support Web Portal, your Customer ID and some basic explanation a few hours later.

All you need to do is activate your account by clicking on the provided link in the e-mail.

You are now ready to create your first case!

You can access the e-Support Web Portal from any computer with an active Internet connection.

A complete help file is available on the e-Support Web Portal to help you use our e-Support Service.

Can I submit questions in my native language?

Since you are interacting with our e-Support Team through a portal, which connects you directly to our central database, e-Support will only accept and deal with queries submitted in English, French or German.

Can I submit my questions at any time?

Yes, you can submit your questions 24/7, but keep in mind that our e-Support Team can only treat your queries from Monday till Friday between 8am and 6pm.

Is there a cost involved for using e-Support?

No, this is a complete free of charge service offered to all registered VAIO customers!

How do I know when the e-Support Team has handled my query/case?

As soon as your case has been dealt with by our e-Support Team, you will receive an e-mail, notifying you that your case has been updated.

Trademarks

Sony, Battery Checker, Click to DVD, Click to DVD BD, DVgate Plus, SonicStage Mastering Studio, VAIO Control Center, VAIO Edit Components, VAIO Media, VAIO Power Management, VAIO Power Management Viewer, My Club VAIO, VAIO Update are trademarks or registered trademarks of Sony Corporation.



and "Memory Stick," "Memory Stick Duo," "MagicGate," "OpenMG," "MagicGate Memory Stick," "Memory Stick PRO," "Memory Stick PRO-HG," "Memory Stick Micro," "M2," Memory Stick logo, VAIO, and the VAIO logo are trademarks or registered trademarks of Sony Corporation.

Blu-ray Disc™ and the Blu-ray Disc logo are trademarks of the Blu-ray Disc Association.

Intel, Pentium, and Intel SpeedStep are trademarks or registered trademarks of Intel Corporation.

Microsoft Windows Vista, Windows Media Center Edition, MS Works, Microsoft Office 2007 Trial, Microsoft Office Ready 2007 and the Windows logo are trademarks or registered trademarks of Microsoft Corporation in the U.S. and other countries.

i.LINK is a trademark of Sony used only to designate that a product contains an IEEE 1394 connection.

Adobe, Adobe Acrobat Standard, Adobe Reader, Adobe Premiere Elements, Adobe Premiere Pro and Adobe Photoshop Elements are trademarks of Adobe Systems Incorporated.

Norton and Norton 360 are trademarks of Symantec Corporation.

Roxio Easy Media Creator is a trademark of Sonic Solutions.

WinDVD for VAIO and WinDVD BD for VAIO are trademarks of InterVideo, Inc.

Sun Java VM is a trademark of Sun Microsystems, Inc.

Google Toolbar, Google Desktop Search, Google Earth and Google Picasa are trademarks of Google.

Skype is a trademark of Skype Limited.

My Club VAIO uses Macromedia Flash™ Player software by Macromedia, Inc., Copyright © 1995-2003 Macromedia, Inc. All rights reserved. Macromedia and Flash are trademarks of Macromedia, Inc.

SD Logo is a trademark. 

SDHC Logo is a trademark. 

MultiMediaCard™ is a trademark of MultiMediaCard Association.

HDMI, the HDMI logo and High-Definition Multimedia Interface are trademarks or registered trademarks of HDMI Licensing LLC.

All other names of systems, products and services are trademarks of their respective owners. In the manual, the ™ or ® marks are not specified.

Specifications are subject to change without notice. All other trademarks are trademarks of their respective owners.

See the online **Specifications** to see what software is available for your model.

