

Hardware Guide

PCV-W series

WANO

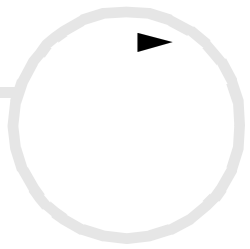

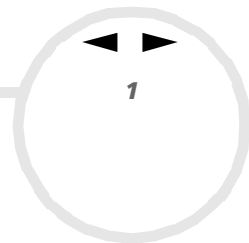

Read this first

Notice

© 2003 Sony Corporation. All rights reserved.

This manual and the software described herein, in whole or in part, may not be reproduced, translated, or reduced to any machine-readable form without prior written approval.

Sony Corporation provides no warranty with regard to this manual, the software, or other information contained herein and hereby expressly disclaims any implied warranties or merchantability or fitness for any particular purpose with regard to this manual, the software or such other information. In no event shall Sony Corporation be liable for any incidental, consequential, or special damages, whether based on tort, contract, or otherwise, arising out of or in connection with this manual, the software, or other information contained herein or the use thereof.

Macrovision: This product incorporates copyright protection technology that is protected by U.S. patents and other intellectual property rights. Use of this copyright protection technology must be authorised by Macrovision, and is intended for home and other limited viewing uses only unless otherwise authorised by Macrovision. Reverse engineering or disassembly is prohibited.

In the manual, the ™ or ® marks are not specified.

Sony Corporation reserves the right to make any modification to this manual or the information contained herein at any time without notice. The software described herein is governed by the terms of a separate user licence agreement.

Please note that the illustrations in this manual may not necessarily apply to your model. Please see the Specifications sheet for the specific configuration of your VAIO.

ENERGY STAR

As an ENERGY STAR Partner, Sony has determined that this product meets the ENERGY STAR guidelines for energy efficiency. The International ENERGY STAR Office Equipment Program is an international program that promotes energy saving through the use of computers and their office equipment. The program backs the development and dissemination of products with functions that effectively reduce energy consumption. It is an open system in which business proprietors can participate voluntarily. The targeted products are office equipment such as computers, displays, printers, facsimiles and copiers. Their standards and logos are uniform among participating nations.

ENERGY STAR is a U.S. registered mark.



Environmental information



Halogenated flame retardant not used in cabinets.

Cushions formed by corrugated board used in packaging.

Owner's record

The serial number and model number are located on your Sony desktop. Record the numbers and refer to them if you call VAIO-Link. See also the printed **Specifications** document.

Safety information

General

- ❑ Risk of explosion if battery is replaced by an incorrect type. Dispose of used batteries according to the instructions.
- ❑ Opening the unit, for whatever reason, could lead to damages that are not covered by the guarantee.
- ❑ To avoid electrical shock, do not open the cabinet. Refer servicing to qualified personnel only.
- ❑ To prevent fire or shock hazard, do not expose your VAIO desktop to rain or moisture.
- ❑ If reporting a gas leak, do not use the modem or a telephone in the vicinity of the leak.
- ❑ Avoid using the modem during a severe electrical storm.
- ❑ The power socket outlet you are using must be installed near the equipment and must be easily accessible.
- ❑ Do not move your computer while the system is in **Standby** mode.
- ❑ The magnetic properties of some objects can have serious consequences for your hard disk drive. They can erase the data on the hard disk drive and cause the computer to malfunction. Do not place your computer near or on any objects, which emit magnetic fields, mainly:
 - ❑ TV sets
 - ❑ Speakers
 - ❑ Magnets and magnetic bracelets.

Audio/video

Audio and picture distortion may occur if this equipment is positioned in close proximity to any equipment emitting electromagnetic radiation.

Connectivity

- ❑ Never install modem or telephone wiring during a severe lightning storm.
- ❑ Never install telephone jacks in wet locations unless the jack is specifically designed for wet locations.
- ❑ Take care when installing or modifying telephone lines.
- ❑ To disconnect your VAIO desktop completely from the mains voltage, unplug the power cable.
- ❑ Make sure that the socket outlet is easily accessible.

Regulatory information

Sony hereby declares that this product is in compliance with the essential requirements and other relevant provisions of European Directive 1999/5/EC (radio equipment and telecommunications terminal equipment Directive).



Declaration of Conformity

The European Union is targeting the free movement of goods for the internal market and to prevent technical barriers to trade. This effort has resulted in several EU Directives asking that manufacturers make their products comply with essential standards. Manufacturers are required to affix the "CE" mark on the products they sell and to draw up a "Declaration of Conformity" (DoC).

Primarily, the Declarations of Conformity are intended for the market surveillance authorities as proof that products satisfy the required standards. Additionally, Sony provides these EU DoC's on the website <http://www.compliance.sony.de> as a service to our customers.

You can search for all Declarations of Conformity available for a specific product by typing in the model name in the search box. A list of matching documents will be displayed and can be downloaded. Please note that the availability of declarations depends on the scope of the EU Directives and the individual product specifications.

This product complies with EN 55022 Class B and EN 55024 for use in the following areas: residential, commercial, and light industrial.

This product has been tested and found compliant with the limits set out in the EMC Directive for using connection cables not longer than 3 metres (9.8 feet).

Before activating the built-in modem, please read the **Modem Regulations** leaflet.

Disposing of the internal memory backup battery

- ❑ Your Sony VAIO desktop is equipped with an internal back-up memory battery (motherboard battery) that should not have to be replaced during the lifetime of the product. If you want to replace the battery, please contact VAIO-Link: <http://www.vaio-link.com>
- ❑ Keep away from children.
- ❑ Dispose of the battery properly at its end-of-life.
- ❑ In some areas the disposal of non-hazardous batteries in household or business waste may be prohibited. Please use the public waste collection system.

Disposing of the AA batteries

- ❑ The bundled remote control is powered by AA batteries.
- ❑ For installing the batteries, please refer to the printed **Getting Started** booklet.
- ❑ Do not handle damaged or leaking batteries.
- ❑ Dispose of promptly and properly at end-of-life.
- ❑ May explode or leak if recharged, disposed of in fire, mixed with other types of battery or improperly installed.
- ❑ Keep away from children.
- ❑ In some areas, the disposal of batteries in household or business waste may be prohibited. Please use the public collection system.

Welcome

Congratulations on purchasing a Sony VAIO desktop. Sony has combined leading-edge technology in audio, video, computing and communications to provide you with state-of-the-art personal computing.

Here are the main features you can enjoy:

- ❑ **Exceptional performance.**
- ❑ **Sony audio and video quality** – The high-quality internal quality speakers and graphics and enable you to take advantage of today's advanced multimedia applications, games, and entertainment software.
- ❑ **Transformability** – Stow away the keyboard and watch as the computer switches from PC to television to sound system!
- ❑ **Multimedia features** – Enjoy audio and video CDs and DVDs, even record them yourself.
- ❑ **Giga Pocket** – Take advantage of the new **Giga Pocket** technology, allowing you to watch TV and record your favourite programs digitally and by remote control.
- ❑ **Sony Memory Stick slot** – The next generation in digital storage allows you to easily transfer images, sounds, data and text between cameras, computers, and more.
- ❑ **VAIO keyboard** – Featuring power-on capabilities and shortcut keys to launch your favourite applications within seconds.
- ❑ **Windows XP Home Edition with Service Pack 1** – Your system includes the latest consumer operating system from Microsoft.
- ❑ **Excellent customer support** – If you are experiencing any problems with your computer, please check the VAIO-Link website for a possible solution: <http://www.vaio-link.com>. Before contacting VAIO-Link, please try to solve the problem by reading this guide, your printed **Guide to Troubleshooting and Using the VAIO Recovery and Documentation Disc**, or the manuals and help files for the peripherals or software.

Documentation pack

Your documentation pack contains printed information and user guides to read on your computer. The user guides are compiled in the **VAIO Info Centre** on the **VAIO Recovery and Documentation Disc** or on a separate disc.

Printed documentation

The printed part of your documentation pack includes the following:

- ❑ A **Getting Started** brochure, where you will find a brief description of the items in your box, and how to set up your computer;
- ❑ A **Specifications** sheet, containing a table of specifications, a list of bundled software and, on the reverse side, a guide to setting up your VAIO;
- ❑ A **Guide to Troubleshooting / Using the VAIO Recovery and Documentation Disc**, where you will find solutions to common problems, an explanation of the purpose and use of the VAIO disc delivered with your computer, and VAIO-Link information;
- ❑ Your **Sony Guarantee** conditions;
- ❑ A **Safety Regulations** leaflet;
- ❑ A **Modem Regulations** leaflet.

Non-printed documentation

The documentation available in the **VAIO Info Centre** on disc, or on a separate disc, includes the following guides:

- ❑ The **Hardware Guide** (this guide).
- ❑ The **Software Guide**, which contains short descriptions of the software features available with VAIO systems.

- ❑ The **Giga Pocket** manual, which explains how to watch and record TV and video on your PC.

Further sources

- ❑ Consult the **Online Help** files of the software you are using for detailed information on features and troubleshooting.
- ❑ Go to <http://www.club-vaio.com> to find online tutorials about your favourite VAIO software.

Ergonomic considerations

Whenever possible, try and take into account the following ergonomic considerations when using your new computer, whether at home or in the office:

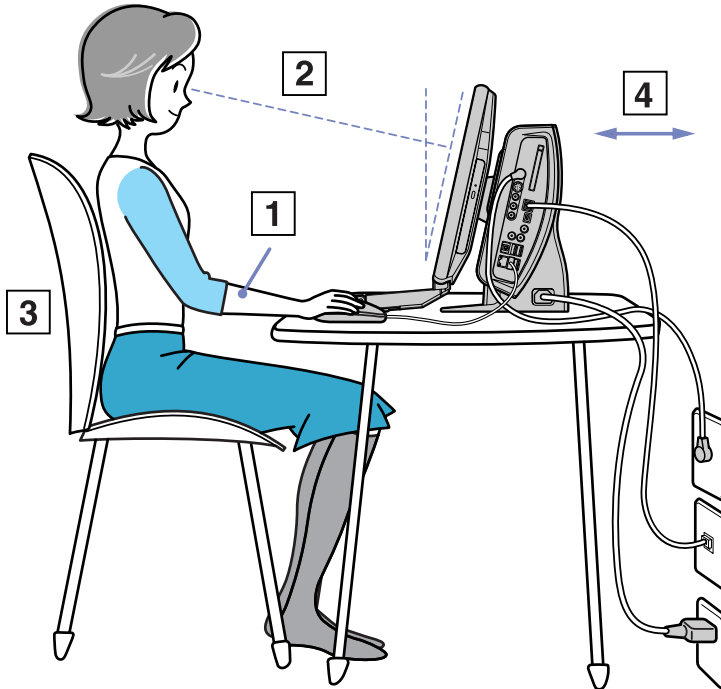

- ❑ **Position of the keyboard and mouse** – Make sure the keyboard is directly in front of you. Keep your forearms horizontal, with your wrists in a neutral, comfortable position (1) while using the keyboard or mouse – not at an angle. Let your upper arms hang naturally at your sides. Place the mouse at the same level as the keyboard and use your whole arm to move it.
- ❑ **Position and viewing angle of the monitor** – Set the display at a comfortable viewing distance (2). Make sure the display screen is at eye level or slightly lower. Use the display's tilting feature to find the best position. You can reduce eye-strain and muscle-fatigue by adjusting the tilt of the display to the proper position. Remember to adjust the brightness setting of the display.
- ❑ **Furniture and posture** - Sit in a chair with good back support (3). Adjust the level of the chair so your feet are flat on the floor. A footrest may make you more comfortable. Sit in a relaxed, upright posture and avoid slouching forward or leaning too far backwards.
- ❑ **Lighting** – Choose a location where windows and lights do not create glare or reflection on the display. Use indirect lighting to avoid bright spots reflecting on the display. Proper lighting adds to your comfort and work effectiveness.
- ❑ **Ventilation** – Make sure you leave at least 25 cm of space behind and on the left of the main unit (4).
- ❑ **And finally** – Remember to have breaks during sessions with your computer. Excessive use of the computer may strain muscles or tendons.

Using your VAIO

Once you have read and followed the information in the printed **Getting Started** guide and **Specifications** sheet, you can start using your computer safely and confidently. Read on to get the most out of using your VAIO computer.

- ❑ Shutting down your computer safely ([page 12](#))
- ❑ Your VAIO as a multimedia system ([page 13](#))
- ❑ Using the keyboard ([page 19](#))
- ❑ Using the TV function ([page 21](#))
- ❑ Using the mouse ([page 22](#))
- ❑ Using the disc drive ([page 24](#))
- ❑ Using the modem ([page 28](#))
- ❑ Using power modes ([page 30](#))
- ❑ Using the Memory Stick ([page 33](#))

Shutting down your computer safely

It is important that you shut down your computer properly so you do not lose unsaved data.

To shut down your computer, proceed as follows:

- 1 Turn off any peripherals connected to your computer.
- 2 Click the **Start** button.
- 3 Click **Turn Off Computer**.
The **Turn off computer** window appears.
- 4 Click **Turn Off**.
- 5 Respond to any prompts warning you to save documents or to consider other users and wait for your computer to turn off automatically.
The power indicator turns off.

 See the printed **Troubleshooting Guide** if you have problems shutting down your computer.

Your VAIO as a multimedia system

The unique advantage of your VAIO is the way it transforms smoothly from one home entertainment unit into the next. Much more than a computer, you can use this unit in your living room as a TV, sound system and digital photo album in one.

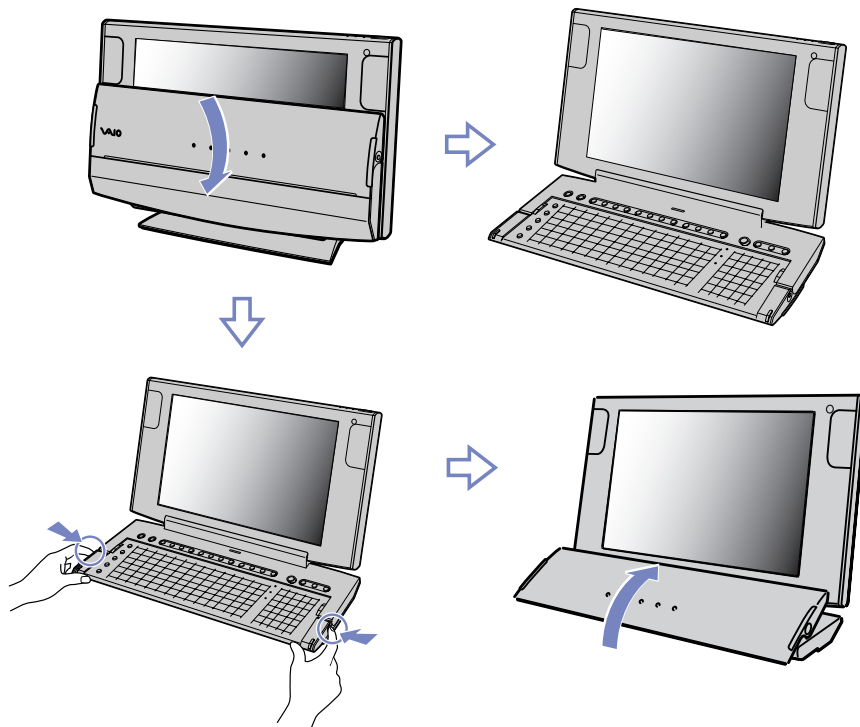

 **SonicStage** and **Giga Pocket** should be installed on your VAIO. If not, simply install them from the **VAIO Recovery and Documentation Disc**.

Computer mode

If you want to work on your VAIO as a desktop computer, fold down the keyboard fully, as shown. Position yourself in front of the computer as described in **Ergonomic considerations** (page 9).

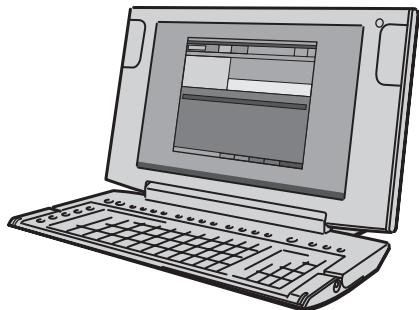

Audio mode

When you want to listen to music on your VAIO and are not using the keyboard or the display, fold the keyboard up to cover the screen, as shown.

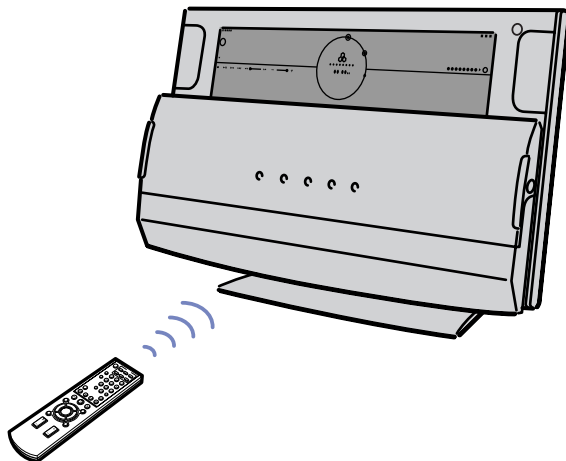

The front panel buttons are now available for you to adjust the volume manually or you can use the remote control.

You can use the **SonicStage** software for listening to music.

TV / video / photo viewing mode

When you want to use the screen on your VAIO, the keyboard can be neatly stowed away so the front panel buttons can be used without covering the screen. The front panel gives you additional TV, channel, and volume control buttons and is equipped with built-in stereo speakers and indicator lights. To set up the VAIO as a TV, push and hold the buttons in on each side of the keyboard and lift then fold it back so it is resting at the bottom of the screen, as shown.

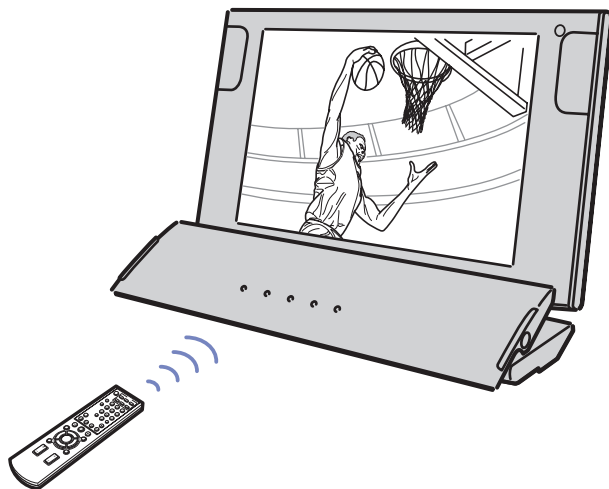

Use the **Giga Pocket** software (you can find the manual on disc) and the remote control to watch television.

Use **VAIO Media** together with the remote control to view your photos in slideshow format.

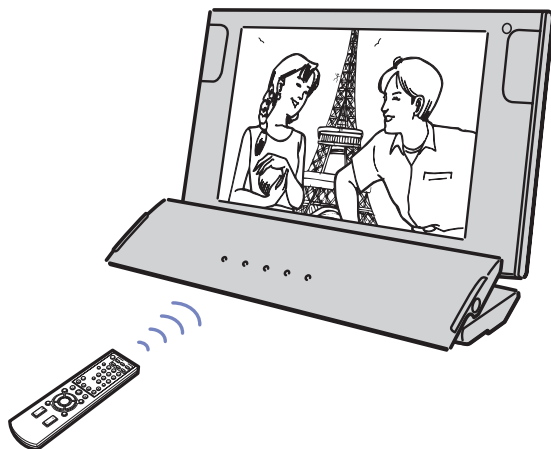
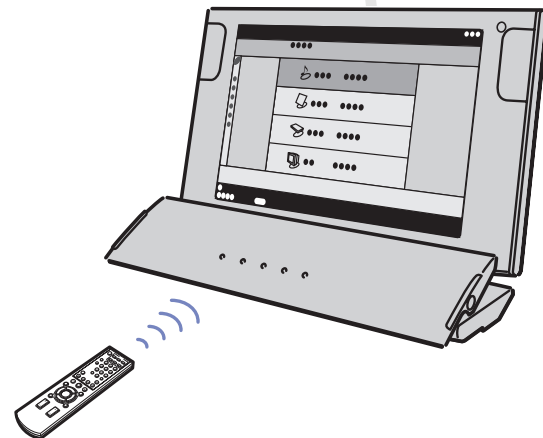

Use **PowerDVD for VAIO** and the remote control to enjoy DVD movies on your VAIO.



Keyboard Closure Setup

With the **Keyboard Closure Setup** software installed on your computer, you can set your computer to launch an appropriate software application when you shift the keyboard from one position to the other.

Using the keyboard

Your VAIO has a built-in keyboard. The features are much the same a standard keyboard, with some additional functions which you may be unfamiliar with.

For more information on the standard keys, please go to the Windows **Help and Support Center**. The VAIO-Link website (www.vaio-link.com) also contains glossary information to help you use the keyboard.

<i>Keys</i>	<i>Descriptions</i>
Shortcut keys (5 Keys)	You can use these buttons, numbered 1 to 6, to launch straight into assigned applications.
<Fn> key	The <Fn> key is used in combination with 5 other keys to execute certain commands.
<div data-bbox="363 588 512 647" style="border: 1px solid black; padding: 5px; text-align: center; margin-bottom: 10px;"><i>PgUp</i></div> <div data-bbox="363 686 512 745" style="border: 1px solid black; padding: 5px; text-align: center; margin-bottom: 10px;"><i>PgDn</i></div> <div data-bbox="363 785 512 844" style="border: 1px solid black; padding: 5px; text-align: center; margin-bottom: 10px;"><i>Home</i></div> <div data-bbox="363 883 512 943" style="border: 1px solid black; padding: 5px; text-align: center; margin-bottom: 10px;"><i>End</i></div> <div data-bbox="363 982 512 1041" style="border: 1px solid black; padding: 5px; text-align: center;"><i>ScrLk</i></div>	<p>These keys are used in combination with the <Fn> key to execute the commands depicted within the box on the key.</p> <p><Fn> + <PgUp>: Moves the view to the next page up.</p> <p><Fn> + <PgDn>: Moves the view to the next page down.</p> <p><Fn> + <Home>: Moves the cursor to the beginning of the line.</p> <p><Fn> + <End>: Moves the cursor to the end of the line.</p> <p><Fn> + <ScrLk>: Changes the way in which you can scroll the screen, depending on the application.</p>

Using the shortcut keys

Press a shortcut key (<S> Key) on the left side of your keyboard to start your favourite software, without having to follow a path on the computer.

If you so wish, you can use **VAIO Action Setup** to change the functions of the <S> Keys. All six buttons are reprogrammable.

The programmable <S> Keys come with the following applications as their default settings (this may vary):

<S1> — **Help and Support Center**

<S2> — **Outlook Express**

<S3> — **Internet Explorer**

<S4> — **SonicStage**

<S5> — **Giga Pocket**

<S6> — **PictureGear Studio**

 **SonicStage** and **Giga Pocket** should be installed on your VAIO. If not, simply install them from the **VAIO Recovery and Documentation Disc**.

Indicators

<i>Light</i>	<i>On</i>	<i>Off</i>
Num Lock	Turns on when the number keys in the numeric keypad are active.	Turns off when the alphanumeric character keys in the keypad area are active.
Caps Lock	Turns on when the letters appear in uppercase as you type. The <Shift> key lowers the case of typed letters when Caps Lock is on.	Turns off when the letters appear in lowercase as you type (unless you hold down the <Shift> key).
Scroll Lock	Turns on when the screen scrolls differently (not all applications support this function).	Turns off when the information moves across the display normally.

Using the TV function

Your computer has been equipped with a TV-tuner board. In combination with Sony's **Giga Pocket** software, it allows you to:

- ❑ Watch, record and play back analogue broadcasted cable and terrestrial TV-programs, all by remote control;
- ❑ Digitise analogue video and audio using the S-Video or composite and audio inputs;
- ❑ Manage your video units (capsules), preview them and create multiple folders;
- ❑ Set up a timer to record channels at a repeated time;
- ❑ Suspend viewing TV (time-shifting);
- ❑ Stream your recorded TV contents via Ethernet (or WLAN) to connected PCs;
- ❑ Export your video capsules to MPEG2, MPEG1 and (DVI) AVI-files;

 Sony cannot guarantee the streaming of recorded content if it is beyond a certain level of high quality.

For details on using **Giga Pocket** and the remote control, please see the dedicated guide on disc, or the help files within the software itself.

Using the mouse

Your computer is delivered with a VAIO USB optical mouse, which uses a light-emitting diode (LED) instead of a ball. Avoid using the mouse on a piece of glass or other transparent material, as this can interfere with smooth cursor movement on the screen.

The mouse has the following functions:

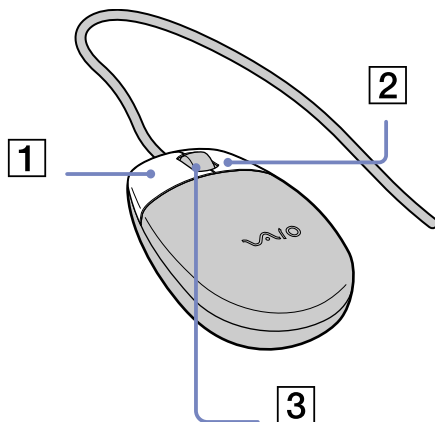

<i>Function</i>	<i>Action</i>
point	Move the entire mouse across a flat surface to place the pointer on an item or object.
click	Press the left button (1) once.
double-click	Press the left button twice.
right-click	Press the right button (2) once. In many applications, this action displays a context-sensitive shortcut menu.
drag and drop	Hold the left button down while sliding the mouse. Then release the button to drop the object.
scroll	Turn the central wheel (3) to scroll up or down a page. Or press the wheel once to lock the scroll action and control the movement by moving the entire mouse (the scroll function is available only with applications that support a scroll feature).

You can adjust the mouse pointer speed and other functions under **Mouse Properties**. To display **Mouse Properties**, go to the **Control Panel**, select **Printers and Other Hardware**, then select **Mouse**.

Setting up the mouse for left-handed users

To set your mouse up for left-handed users, proceed as follows:

- 1 Go to **Start**, select **Control Panel**, then click the **Printers and Other Hardware** option.
- 2 Click the mouse icon.
The **Mouse Properties** dialog box appears.
- 3 In the **Buttons** tab, select the option button next to **Switch primary and secondary buttons**.
- 4 Click **OK**.
The new mouse settings are now in place.

Using the disc drive

Your computer is equipped with a DVD-RW drive, which reads data from a compatible CD or DVD and writes data to a DVD-RW, DVD-R, CD-RW, or CD-R.

To insert a disc, proceed as follows:

- 1 Turn on the computer.
- 2 Press the eject button to open the drive.

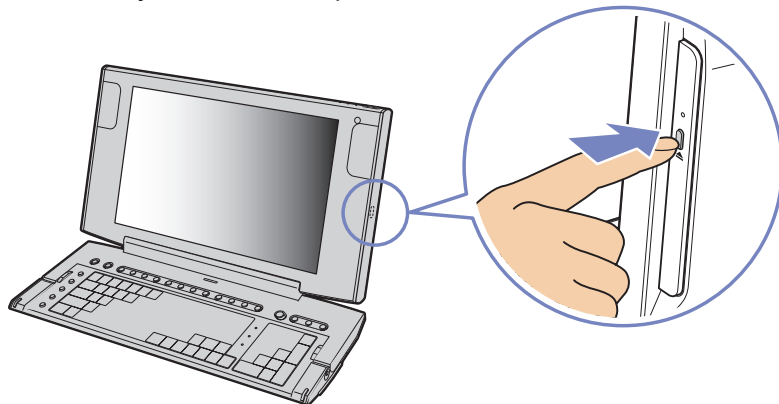

The tray slides out.

- 3 Place a disc in the tray with the label side facing outwards. Make sure the disc is secure in the centre of the tray.

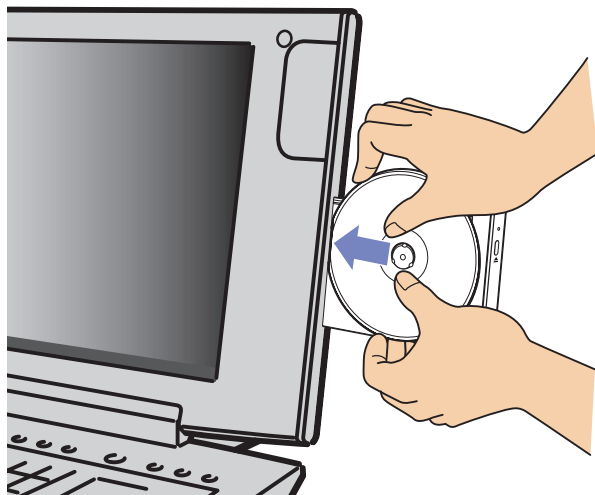

- 4 Close the tray by pushing it gently.
 See the printed **Troubleshooting Guide** if you have problems using discs.

Reading and writing CDs and DVDs

To achieve optimum performance when writing data on to disc (also called 'burning'), follow these recommendations:

- ❑ Only use circular discs. Do not use discs with any other shape (star, heart, card, etc.), as this may damage the disc drive.
- ❑ Do not strike or shake the computer while writing data to a disc.
- ❑ For optimum writing speed, deactivate the screensaver before writing data to a disc.
- ❑ Memory-resident disc utilities may cause unstable operation or data loss. Deactivate these utilities before writing data to a disc.
- ❑ When using a software application to burn discs, make sure you exit and close all other applications.
- ❑ Never touch the surface of the disc. Fingerprints and dust on the surface of a disc may cause writing errors.
- ❑ Never put stickers on discs. This will affect the use of the disc irreparably.

Playing DVDs

To achieve optimum performance when playing DVDs, you should follow these recommendations:

- ❑ Close all open applications before playing a DVD movie.
- ❑ You can play DVDs with the software **PowerDVD for VAIO**.
- ❑ If you want to play a DVD and use **Giga Pocket** at the same time, please launch **Giga Pocket** before **PowerDVD for VAIO**.
- ❑ Do not switch power saving modes while playing a DVD.
- ❑ Do not use built-in utility applications to speed up the access of discs, because they may cause the system to become unstable.
- ❑ Make sure that the screensaver is deactivated.
- ❑ Region codes indicators are labelled on the DVDs to indicate in which region and on what type of player you can play the disc. Unless a '2' (Europe belongs to region '2') or 'all' (this means that you can play this DVD everywhere in the world) is labelled on your DVD disc or on the packaging, you cannot play the disc on this player.
- ❑ Do not try to change the region code settings of the DVD drive. Any difficulties caused by changing the region code settings of the DVD drive are out of warranty.

Using the modem

Your VAIO desktop is equipped with an internal modem. As described in the printed **Getting Started** guide, use the single RJ-11 jack to connect the supplied modem cable to the phone line. Once you have connected the phone line and registered with an Internet Service Provider, you can take advantage of online services and the Internet, to register your computer and software online, and to contact VAIO-Link.

Troubleshooting the modem

My modem does not work or cannot establish a connection

- ❑ Check that the phone line is plugged into your computer.
- ❑ Make sure that the modem is the only device connected to your phone line.
- ❑ Check that the phone line is working. You can check the line by plugging in an ordinary phone and listening for a dial tone.
- ❑ Check that the phone number the program is dialling is correct. The modem dialling mode may be incompatible with your telephone line.
- ❑ The modem may not work properly if you are with a Private Automatic Branch eXchange (PABX).
- ❑ In the **Phone and Modem Options** dialog box (**Control Panel / Phone and Modem Options**), check that your modem is listed in the **Modems** tab, and that the location information is correct on the **Dialing Rules** tab.
If you do not see the **Phone and Modem Options** icon, click **Switch to Classic View** on the left side.
- ❑ For users in UK: A country-specific phone plug is supplied with your VAIO desktop, allowing you to plug the phone line into the wall jack. We recommend you to use the supplied plug, because the usage of any other phone plug can decrease the connection quality.

- ❑ Your computer cannot be connected to a coin-operated telephone, and may not work with multiple phone lines or a private branch exchange (PBX). If you connect the modem to a parallel connected phone line, the modem or the other connected device may not function properly. Some of these connections may result in excess electrical current and could cause a malfunction in the internal modem.
- ❑ Only DTMF (Dual Tone Multi Frequency) signalling (tone dialling) is supported.

My modem connection is slow

Many factors influence modem connection speed, including telephone line noise or compatibility with telephone equipment (such as fax machines or other modems). If you think your modem is not connecting properly to other PC-based modems, fax machines, or your Internet Service Provider, check the following:

- ❑ Have your phone company check that your phone line is free from any line noise.
- ❑ If your problem is fax-related, check that there are no problems with the fax machine you are calling and that it is compatible with fax modems.
- ❑ If you are having a problem connecting with your Internet Service Provider, check that the ISP is not experiencing technical problems.
- ❑ If you have a second phone line available, try connecting the modem to that line.

Using power modes

The colour of the power indicator light at the top of the display tells you which mode the computer is in.

<i>Power indicator</i>	<i>Mode</i>
Green	Computer is in Normal mode
Amber	Computer is in Standby mode
No light	Computer is turned off or in Hibernate mode

 Please see the printed **Specifications** sheet for the exact location of the indicators.

To set the timer for your computer to automatically enter **Standby** or **Hibernate** mode after a certain amount of time, go to **Control Panel**, click **Performance and Maintenance** and change the settings under **Power Options**.

Using **Standby** mode

If you plan to stop using your computer for a short period of time (not overnight), you can put it into **Standby** mode instead of turning it off completely. Putting the computer into **Standby** mode saves energy and allows a quick return to normal computer use.

To activate **Standby** mode manually, proceed as follows:

- 1 Save your work, close all applications and close your Internet connection, if applicable.
- 2 From the **Start** menu on the Windows taskbar, select **Turn Off Computer**.
Alternatively, press <Alt>+<F4> to get to the same dialog box.
- 3 Select **Stand By**.
The computer goes into **Standby** mode, indicated by the amber light of the power indicator.

To return to **Normal** mode, press any key on the keyboard.

 You can leave Windows running when using **Standby**.

When the computer is in **Standby** mode, you cannot insert a disc.

The computer comes out of **Standby** mode quicker than out of **Hibernate** mode and uses more power.

Using **Hibernate** mode

If you are interrupted and need to leave your computer suddenly, you can put it into **Hibernate** mode. This power saving mode saves you the time of shutting down in the normal way.

When you put your computer into **Hibernate** mode:

- ❑ Everything in the memory is saved to the hard disk.
- ❑ The monitor and system are turned off.
- ❑ The computer is turned off.
- ❑ The power indicator light turns off.

To activate **Hibernate** mode manually, use the Windows taskbar:

- 1 Save your work.
- 2 From the **Start** menu on the Windows taskbar, select **Turn Off Computer**.
Alternatively, press <Alt>+<F4> until the **Turn Off Computer** screen is displayed.
- 3 In the **Turn Off Computer** screen, hold down the <Shift> key to reveal the **Hibernate** button.
- 4 Click **Hibernate**.
The computer goes into **Hibernate** mode, the computer turns off.

To return to **Normal** mode, quickly press the power button.

Operation returns to the same state as before.

 You can leave Windows running when using **Hibernate**.

If you press the power button for more than six seconds, the computer will switch off completely.

When the computer is in **Hibernate** mode, you cannot insert a disc.

Hibernate uses less power than **Standby** and requires more time.

Using the Memory Stick

Your VAIO computer is designed to support the Memory Stick. The Memory Stick is a compact, portable, and versatile device especially designed for exchanging and sharing digital data with compatible products, such as digital cameras, mobile phones and CLIE handheld devices. Because it is removable, it can be used for external data storage.

Use the flash memory technology to download anything that can be converted into digital data, such as pictures, music, words, sounds, movies and photographs.

The Memory Stick family ranges in capacity and compatibility. To find out more about the Memory Stick features, go to the **VAIO Info Centre**, click on **Welcome > Cool Sony Links** and then **Memory Stick**. This will take you to the dedicated website.

Please see your printed **Specifications** sheet to see which Memory Stick types are compatible with your VAIO and if there are any limitations.

- ❑ You can purchase Memory Sticks from the Sony Style website (www.sonystyle-europe.com), or from your local Sony dealer.
- ❑ Detailed information about which CLIE handhelds are compatible with which Memory Sticks can be found here: www.clie-link.com.
- ❑ Detailed information about which VAIO computers are compatible with which Memory Sticks can be found here: www.vaio-link.com.

Inserting a Memory Stick

To insert a Memory Stick, proceed as follows:

- 1 Locate the Memory Stick slot on the left-hand side of the display.
- 2 Hold the Memory Stick with the connectors pointing towards the back and push it in until it clicks.

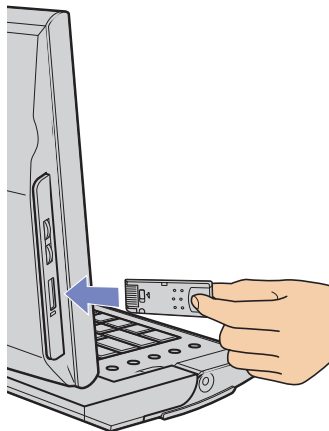

The Memory Stick is automatically detected by your system and appears in the **My Computer** window with its own drive.

-  Always hold the Memory Stick with the arrow pointing in the correct direction when you insert it into the slot. To avoid damaging the computer or the Memory Stick, do not force the Memory Stick into the slot if it does not insert smoothly.

Removing a Memory Stick

To remove a Memory Stick, proceed as follows:

- 1 Make sure the indicator light is not on.
- 2 Push the Memory Stick in to release it, and then pull it out.

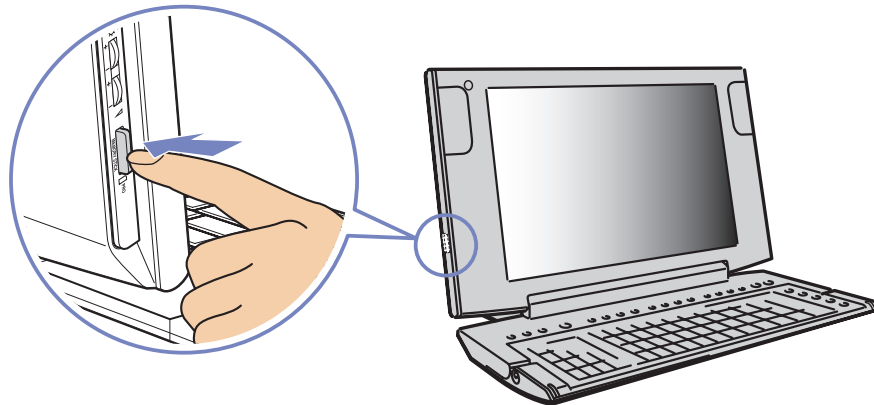

 Always remove the Memory Stick gently, or it may pop out unexpectedly.

You are recommended to remove the Memory Stick before shutting down the computer.

If an error message appears when you remove it, insert the Memory Stick into the slot again and press **<Enter>**. Wait until the active application finishes, then remove the Memory Stick. If the message confirms the ejection of the Memory Stick, click **OK**.

Connecting peripheral devices

You can add functionality to your computer by using the various ports on your unit.

- ❑ Connecting a Universal Serial Bus (USB) device ([page 37](#))
 - ❑ Connecting an i.LINK device ([page 39](#))
 - ❑ Connecting an S/PDIF device ([page 42](#))
 - ❑ Connecting a microphone ([page 42](#))
 - ❑ Connecting to a network ([page 43](#))
-
- ❑ To identify and locate the ports on your computer, please see the printed **Specifications** sheet.
 - ❑ Sony computer supplies, accessories and peripherals can be purchased from your local retailer or from the Sony website: www.sonystyle-europe.com
 - ❑ For more information about connection compatibility, go to the VAIO-Link website: www.vaio-link.com

Connecting a Universal Serial Bus (USB) device

You can connect a USB device such as a scanner, a floppy disk drive or a printer, to your VAIO desktop.

To connect a USB device, simply plug in the USB cable of the device into one of the ports on your computer. There are USB 2.0 ports on the right-hand side of your system unit.

USB devices are hot plug and play devices. You do not need to shut down your computer prior to connecting these devices unless the manual supplied with the device states otherwise.

For some USB devices you need to install the software before you connect the device. Not following this procedure might cause the device not to work properly. For more information, check the manual provided with the USB device.

Connecting a USB printer

USB printer drivers should be automatically installed although some printers do not function properly without updated drivers.

You can check the printer manufacturer's website for the latest drivers for Windows XP Home Edition Service Pack 1 before installing your printer.

Once you plug the printer's USB cable into one of the USB ports on your computer, the **Found New Hardware Wizard** will guide you through any setup procedure you need to follow.

If the printer is not automatically installed, you can try the following:

- 1 From the **Control Panel**, select **Printers and Other Hardware**, then **Printers and Faxes**.
- 2 Under **Printer Tasks**, click **Add a printer**.
- 3 Let the **Add Printer Wizard** guide you through the installation process.
- 4 Click **Finish**.
The printer is now installed.

 This procedure applies for most, but not for all printers.



Troubleshooting printing

If you have problems printing, check the printed **Troubleshooting Guide**; the documentation delivered with your printer; and the VAIO-Link website (www.vaio-link.com).

Connecting an i.LINK device

Your VAIO computer includes a 4-pin i.LINK port on the right-hand side of the system unit. Use this port to connect an i.LINK device such as an optical disc drive, a digital video camera recorder or to link up two VAIO computers so you can copy, delete or edit files.

- ❑ The i.LINK device will need its own power supply.
- ❑ You are strongly advised to use only Sony i.LINK cables, as using other brands may cause problems with the i.LINK devices.
- ❑ The i.LINK connection may vary, depending on the software applications, operating system, and compatible i.LINK devices. Not all products with an i.LINK connection may communicate with each other.
- ❑ Please refer to the documentation that came with your compatible i.LINK device and software for information on operating conditions and proper connection.

Connecting a digital video camera recorder

To connect a digital video camera recorder, proceed as follows:

- 1 Plug one end of the i.LINK cable (not supplied) into the i.LINK port of the computer and the other end into the DV out port on your digital video camera recorder. On Sony digital video cameras, ports marked DV out, DV in/out or i.LINK are i.LINK-compatible.

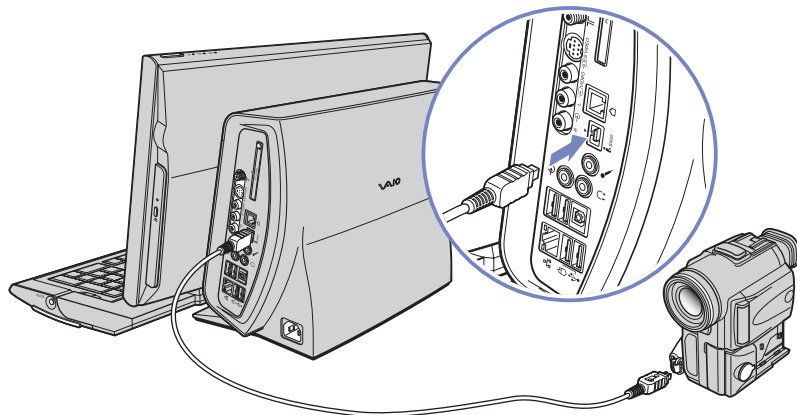

- 2 Launch the **DVgate** application (see the Help files within the software itself for more information).

 The Sony digital video camera recorder is an example; your digital video camera recorder may need to be connected differently.

If your digital video camera recorder includes a Memory Stick slot, you can use it to copy images from the camera to your computer. To do so, simply copy images on the Memory Stick, and then insert it into the Memory Stick slot of your computer.

If the connected i.LINK device is not recognised, disconnect the i.LINK device, then connect it again.

Troubleshooting i.LINK devices

I cannot establish an i.LINK connection between two VAIO computers

- ❑ You must have administrator rights on your computer to be able to link the two.
- ❑ Disconnect then reconnect the i.LINK cable.
- ❑ If you still have no connection after waiting for a while, restart both computers.
- ❑ If either computer has just returned from a power saving mode, the connection may be affected. In this case, make sure you perform a full restart before connecting them.
- ❑ Check that both units are in the same workgroup, and that the **Sharing** option is enabled.

When I record images to a digital video device using DVgate, I see an error message

Close all open applications and restart your computer. Frequently recording images to a digital video device while using **DVgate** sometimes causes this error.

I cannot use digital devices

- ❑ Check that the DV device is turned on and that the cables are properly connected.
- ❑ If you are using multiple i.LINK devices, the combination of the connected devices may cause unstable operation. If this is the case, turn off all connected devices and disconnect unused devices. Check the connection and then turn on the power again.
- ❑ You are strongly advised to use only Sony i.LINK cables, as using other brands may cause problems with the i.LINK devices.

Connecting an S/PDIF device

The S/PDIF (Sony/Philips Digital Interface) port on your computer allows you to transfer audio files to optical devices. The advantage is that it does not use the conversion to and from an analog format, which could degrade the signal quality.

Please read the documentation provided with your optical device for connection information.

Connecting a microphone

Your VAIO desktop does not contain an internal microphone. If you need to use a sound input device, for example to chat on the Internet, you need to plug in an external microphone.

To connect an external microphone, plug the microphone cable into the microphone connector, identified by the symbol .

 Make sure your microphone is designed for computer use.

Connecting to a network

Your computer comes with a built-in Ethernet interface.

To connect to a network, proceed as follows:

- 1 Connect your 10BASE-T/100BASE-TX Ethernet cable (not supplied) to the Ethernet port on the back of the computer.
If there is a sticker covering the Ethernet port, this is to remind customers in Germany not to insert an ISDN cable (see caution below).

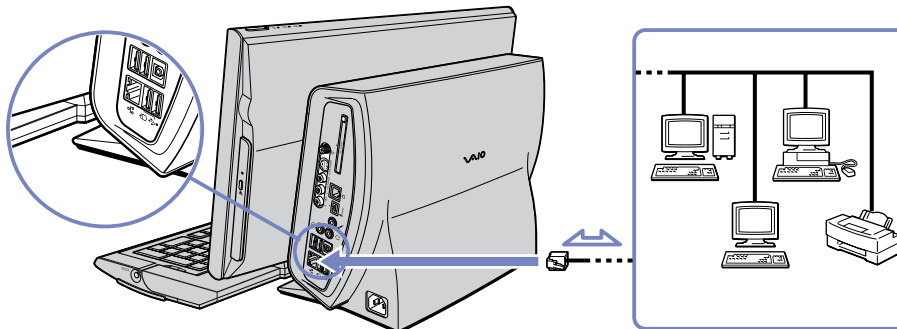

- 2 Go to **Start**, right-click **My Computer** and select **Properties**.
- 3 Click the **Hardware** tab and select **Device Manager**.
The **Device Manager** screen appears with the list of devices.
- 4 Under **Network Adapters**, right-click the name of the adapter.
- 5 Click **Properties**.
- 6 Under **Device Usage**, select **Use this device (enable)**.



7 Click **OK** to close the **Properties** window.
The Ethernet connection is now enabled.

! Connect only 10BASE-T/100BASE-TX cables to the Ethernet port. Using other cables or a telephone cable may cause a malfunction, excessive heat or even fire in the port. If using this computer in Germany, please make sure you do not use an ISDN cable. It is physically very similar, but its higher voltage of 12V may destroy the motherboard inside the computer.

 For more information about connecting your VAIO desktop to the network, please consult the hardware troubleshooting section of the VAIO-Link website (www.vaio-link.com):

For help on connecting to a network, see your network administrator if you have one.

Upgrading your VAIO computer

Sony recommends contacting your local dealer for upgrade or maintenance of your new computer. Your local dealer has knowledge of this specialised personal computer and familiar with the safety practices and regulatory compliance required for using and modifying electronic equipment.

The upgrading procedures described in this section assume that you are familiar with the general terminology associated with personal computers and with the safety practices and regulatory compliance required for using and modifying electronic equipment.

Disconnect the computer from its power source and from telecommunication links, networks, or modems before you open the unit or follow any procedures described in this section.

Your computer may not be equipped with all of the hardware features mentioned in this section. The interior configuration of your system may vary from the illustrations, depending on the computer purchased.

To view the hardware configuration for your computer, see the printed **Specifications** sheet.

Your VAIO desktop and memory modules use high precision components and electronic connector technology. To avoid the invalidation of your guarantee by mishandling, it is recommended that:

- You contact your local Sony dealer to install any new internal hardware components.
- You do not install memory modules yourself, if you are not familiar with upgrading memory on a computer.
- Please contact VAIO-Link if you need assistance.

! Failure to disconnect your computer from its power source may result in personal injury or equipment damage.

! Electrostatic discharge (ESD) can damage disk drives, add-on cards, and other components. Follow the procedures here only at an ESD workstation. Otherwise, do not work on a carpeted area and do not handle materials that produce or hold static electricity, such as cellophane wrappers. Ground yourself by keeping constant contact with an unpainted metal part of the unit while carrying out any of these procedures.



Upgrading memory

In the future, you may want to upgrade the memory installed on your VAIO by replacing / adding memory modules. However, we recommend that you do not install them yourself unless you are familiar with upgrading memory on a computer.

For memory upgrades, use only those modules mentioned in the printed **Specifications** table.

Be careful when adding memory yourself. Mistakes on installation or removal of the memory module may cause a malfunction.

Electrostatic discharge can damage electronic components. Before touching a memory expansion board, remember the following:

- ❑ Handle the memory module gently.
 - ❑ The procedures described in this document assume familiarity with the general terminology associated with personal computers and with the safety practices and regulatory compliance required for using and modifying electronic equipment.
 - ❑ Disconnect the system from its power source and from any telecommunication links, networks, or modems before you open the system. Failure to do so may result in personal injury or equipment damage.
 - ❑ Do not open the memory module package until you are ready to install the module. The package protects the module from ESD.
 - ❑ Use the special bag delivered with the memory module, or wrap the module in aluminium foil to protect it from electrostatic discharge.
-  Do not place the memory module in places subject to: Heat sources such as radiators or air ducts, direct sunlight, excessive dust, mechanical vibration or shock, strong magnets or speakers that are not magnetically shielded, ambient temperature of more than +35°C or less than +5°C, or high humidity.
-  Introducing any liquids or any foreign substances or objects into the memory slots, or other internal components of the computer, will result in damage to the computer and any repairs will be out of warranty.

Adding / replacing a memory module

If you are not familiar with upgrading memory on a computer, we highly recommend that you contact your dealer.

To add or change a memory module, proceed as follows:

- 1 Shut down the computer, unplug it, remove any peripheral devices and wait for the computer to cool down.
The inside of the main unit becomes very hot during operation.
- 2 Locate and press the release button on the side of the system unit cover, behind the display.

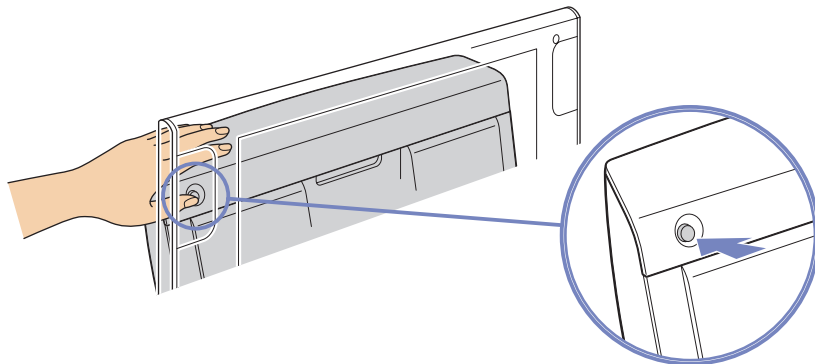

- 3 With the release button pressed, slide the cover to the right and lift away from the system unit.

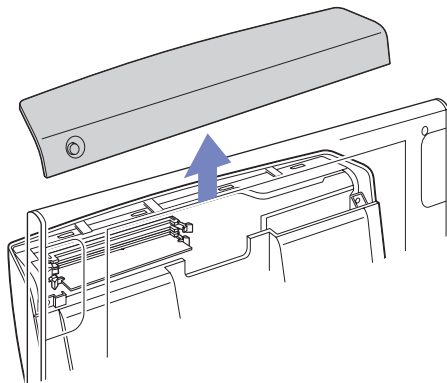
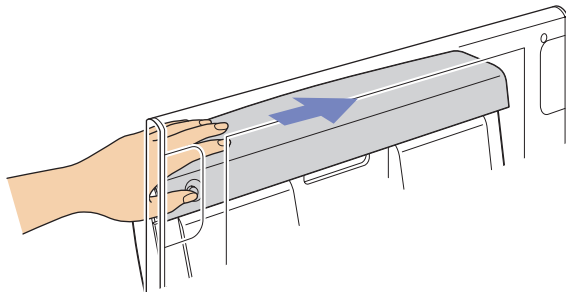

- 4 To remove an existing memory module, locate the memory module(s) you want to remove.

- 5 Push out on the latches, located on both sides of the module, to gently eject it from the slot.

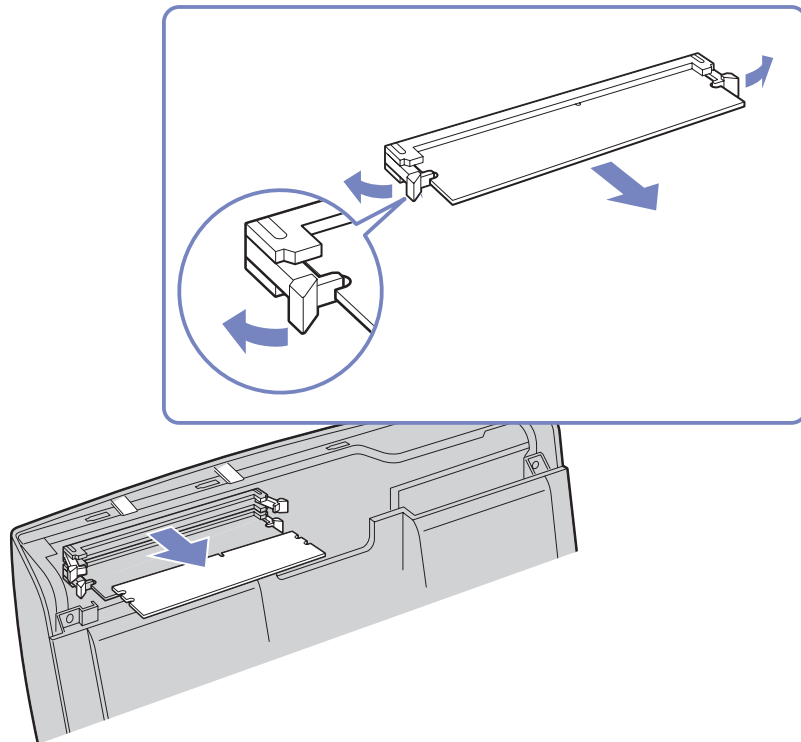

- 6 Hold the module by the sides and store it in a static-free bag.
- 7 To insert a new memory module, remove the memory module from its anti-static package, handling it by the edges.

- 8 Locate the notch on the bottom edge of the module and align the module to the open memory module slot.

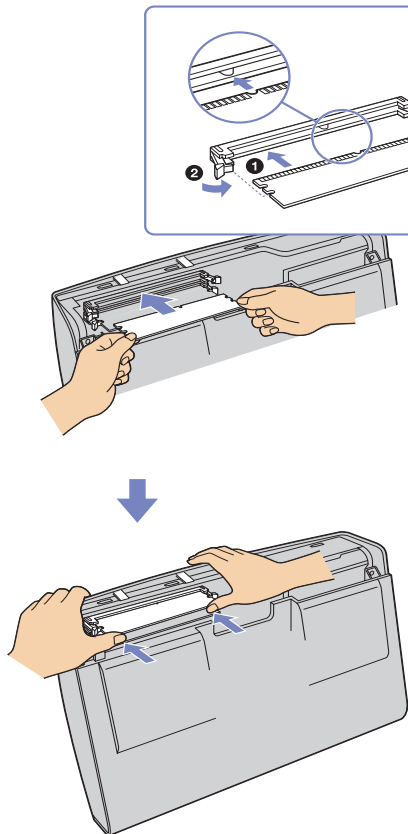

- 9 Firmly insert the bottom edge of the module into the slot.

- 10 Press evenly against the module's upper corners. The side latches snap into position, holding the memory module in place.
 - 11 Now replace the unit cover by aligning the tabs on the cover to the tracks on the system unit's chassis.
 - 12 Gently slide the cover to the left, until the tabs lock the cover into place.
-  There is only one correct way to insert the memory module. Make sure the rivet of the module is lined up with the connector.
- ! Use only the memory modules specified on the printed **Specifications** sheet.
 - ! **To avoid damaging a memory module or the memory module slot, move the side latches slightly outward to relieve pressure. The module is properly inserted when the side latches click into place.**

Viewing the amount of memory

To view the amount of memory, proceed as follows:

- 1 Turn on the computer.
- 2 Click the **Start** button, point to **All Programs**, then **VAIO System Information**, and click **VAIO System Information** again.
You can view the amount of installed memory here.

Getting help

This section describes how to get help and support if something goes wrong with your computer. Sony offers you many support options for your computer.

Sony documentation

Please see the section **Documentation pack (page 7)** for details on the printed and online documentation delivered with your computer, as well as further sources of reference.

Other sources of information

- ❑ Go to the **online help files** that accompany your software for instructions on using the software.
- ❑ **VAIO-Link website:** If you have any problems with your computer, you can access the VAIO-Link website for troubleshooting. Go to: www.vaio-link.com
- ❑ **e-Support:** This interactive part of our website www.vaio-link.com allows you to get in contact with our dedicated support team over the internet. Using a personalised account, you can log your technical queries with ease.
- ❑ **VAIO-Link help lines:** Before contacting VAIO-Link by telephone, try to solve the problem by reading the online and printed documentation.
- ❑ Visit the other Sony websites:
 - ❑ www.club-vaio.com if you want to know more about VAIO and become part of the growing VAIO community.
 - ❑ www.sonystyle-europe.com for online purchases.
 - ❑ www.sony.com for other Sony products.



You need to set up an Internet connection before you can access the online features described here.

e-Support

What is e-Support?

You have searched our user guides and website (www.vaio-link.com) but have not found an answer to your question/issue? e-Support is the ideal solution for you!

Our e-Support Web Portal is an interactive website on which you can submit any technical query you may have regarding your VAIO and receive answers from our dedicated support team.

Every submitted query will result in a unique 'case number' to ensure smooth communication between yourself and the e-Support Team.

Who can use e-Support?

All registered VAIO customers are entitled to unlimited access to the VAIO-Link e-Support Web Portal.

How can I access the e-Support portal?

When you register your VAIO computer online at Club-VAIO (www.club-vaio.com), you will automatically receive an email with the link to the e-Support Web Portal, your Customer ID and some basic explanation a few hours later.

All you need to do is activate your account by clicking on the provided link in the email.

You are now ready to create your first case!

You can access the e-Support Web Portal from any computer with an active Internet connection.

A complete help file is available on the e-Support Web Portal to help you use our e-Support Service.

Can I submit questions in my native language?

Since you are interacting with our e-Support Team through a portal, which connects you directly to our central database, e-Support will only accept and deal with queries submitted in English.

Can I submit my questions at any time?

Yes, you can submit your questions 24/7, but please keep in mind that our e-Support Team can only treat your queries from Monday till Friday between 8am and 6pm.

Is there a cost involved for using e-Support?

No, this is a complete free of charge service offered to all registered VAIO customers!

How do I know when the e-Support Team has handled my query/case?

As soon as your case has been dealt with by our e-Support Team, you will receive an email, notifying you that your case has been updated.

Precautions

This section describes safety guidelines and precautions to help you protect your computer from potential damage.

Please contact VAIO-Link if you need assistance.

- ❑ On handling the hard disk ([page 56](#))
- ❑ On using the power source ([page 57](#))
- ❑ On handling your computer ([page 58](#))
- ❑ On handling the LCD screen ([page 59](#))
- ❑ On handling compact discs ([page 60](#))
- ❑ On handling Memory Sticks ([page 61](#))

On handling the hard disk

The hard disk has a high storage density and reads or writes data in a short time. However, it can be easily damaged by mechanical vibration, shock or dust.

Although the hard disk has the internal safety device to prevent losing data due to mechanical vibration, shock or dust, you should be careful when handling your computer.

To avoid damaging your hard disk:

- ❑ Do not subject your computer to sudden movements.
- ❑ Keep the computer away from magnets.
- ❑ Do not place your computer in a location subject to mechanical vibration or in an unstable position.
- ❑ Do not move your computer while the power is on.
- ❑ Do not turn off the power or restart the computer while reading or writing data to disk.
- ❑ Do not use your computer in a place subject to extreme changes in temperature.

 If the hard disk is damaged, the data cannot be restored.

On using the power source

- ❑ See the printed **Specifications** sheet to check the power operation of your VAIO.
- ❑ Do not share the AC outlet with other high power-consuming equipment, such as a photocopier or shredder.
- ❑ You can purchase a power strip with a surge protector. This device prevents damage to your computer caused by sudden power surges, in an electrical storm, for example.
- ❑ Do not place heavy objects on the power cord.
- ❑ To disconnect the cord, pull it out by the plug. Never pull the cord itself.
- ❑ Unplug your computer from the wall outlet if you are planning to not use the computer for a long time.
- ❑ Make sure that the socket outlet is easily accessible.

On handling your computer

- ❑ Clean the unit with a soft cloth, which is either dry or lightly moistened with a mild detergent solution. Do not use any type of abrasive pad, scouring powder, or solvent such as alcohol or benzine, as these may damage the finish of your computer.
- ❑ Should you drop a solid object or any liquid onto the computer, shut down your computer and then unplug it. You may want to have the computer checked by qualified personnel before operating it again.
- ❑ Do not drop the computer or place heavy objects on top of the computer.
- ❑ Do not place your computer in a location subject to:
 - ❑ Heat sources, such as radiators or air ducts
 - ❑ Direct sunlight
 - ❑ Excessive dust
 - ❑ Moisture or rain
 - ❑ Mechanical vibration or shock
 - ❑ Strong magnets or speakers that are not magnetically shielded
 - ❑ An ambient temperature of more than 35°C or less than 5°C
 - ❑ High humidity.
- ❑ Do not place electronic equipment near your computer. The electromagnetic field of your computer may cause a malfunction.
- ❑ Provide adequate air circulation to prevent internal heat from building up. Do not place your computer on porous surfaces such as rugs or blankets, or near material such as curtains or draperies that may block its ventilation slots.
- ❑ The computer uses high-frequency radio signals and may cause interference to radio or TV reception. Should this occur, relocate the computer a suitable distance away from the set.
- ❑ Use only specified peripheral equipment and interface cables; otherwise, problems may occur.

- ❑ Do not use cut or damaged connection cables.
- ❑ If the computer is brought directly from a cold location to a warm one, moisture may condense inside your computer. In this case, allow at least one hour before turning on your computer. If any problems occur, unplug your computer and contact VAIO-Link.
- ❑ Make sure you disconnect the power cord before cleaning the computer.
- ❑ As you may lose important data once your computer is damaged, you should back up your data regularly. You can restore most of the original application programs from the supplied disc (read the **Guide to Troubleshooting and Using the VAIO Recovery and Documentation Disc** for details).

On handling the LCD screen

- ❑ Do not leave the LCD facing the sun as it can damage the LCD. Be careful when using the computer near a window.
- ❑ Do not scratch the LCD or exert pressure on it. This could cause malfunction.
- ❑ Using the computer in low temperature conditions may produce a residual image on the screen. This is not a malfunction. When the computer returns to normal temperature, the screen returns to normal.
- ❑ A residual image may appear on the screen if the same image is displayed for a lengthy period of time. The residual image disappears in a while. You can use a screensaver to prevent residual images.
- ❑ The screen becomes warm during operation. This is normal and does not indicate a malfunction.
- ❑ The LCD is manufactured using high-precision technology. You may, however, see tiny black points and/or bright points (red, blue, or green) that continuously appear on the LCD. This is a normal result of the manufacturing process and does not indicate a malfunction.
- ❑ Avoid rubbing the LCD screen, as this can damage the screen. Use a soft, dry cloth to wipe the LCD screen.

On handling compact discs

- ❑ Do not touch the surface of the disc.
- ❑ Do not drop or bend the disc.
- ❑ Fingerprints and dust on the surface of a disc may cause reading errors. Always hold the disc by its edge and central hole, as shown.

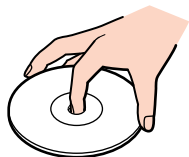

- ❑ Proper care of the disc is essential to its continuous reliability. Do not use solvents such as benzene, thinning agents, commercially available cleaners or anti-static spray, as they may cause damage to the disc.
- ❑ For normal cleaning, hold the disc by its edge and use a soft cloth to wipe the surface from the centre out.
- ❑ If the disc is badly soiled, moisten a soft cloth with water, wring it out well, and use it to wipe the surface of the disc from the centre out. Wipe off any remaining moisture with a dry soft cloth.
- ❑ Never put stickers on discs. This will affect the use of the disc irreparably.

On handling Memory Sticks

- ❑ Do not touch the Memory Stick connector with your finger or metallic objects.
- ❑ Use only the label supplied with the Memory Stick as a label.
- ❑ Do not bend, drop, or apply heavy shock to the Memory Stick.
- ❑ Do not disassemble or modify Memory Sticks.
- ❑ Do not let Memory Sticks get wet.
- ❑ Do not use or store Memory Sticks in a location subject to:
 - ❑ Extremely high temperatures, such as in a car parked in the sun
 - ❑ Direct sunlight
 - ❑ High humidity or
 - ❑ Corrosive substances.
- ❑ Use the storage case supplied with the Memory Stick.

Trademarks

Sony, DVgate, DVgate Plus, Giga Pocket, HotKey Utility, Memory Stick Formatter, PictureGear Studio, SonicStage, SonicStage Mastering Studio, Sony Notebook Setup, Sony Style Imaging, UI Design Selector, VAIO Action Setup, VAIO Edit Components, VAIO Media, VAIO System Information, Memory Stick, the Memory Stick logo, VAIO and the VAIO logo are trademarks of Sony Corporation.

Microsoft, Internet Explorer, Windows Movie Maker, Windows Media Player, Windows XP Professional, Windows Home Edition, Microsoft Works and the Windows logo are trademarks or registered trademarks of Microsoft Corporation in the U.S. and other countries.

i.LINK is a trademark of Sony used only to designate that a product contains an IEEE1394 connection.

Adobe, Adobe Acrobat Reader, Adobe Reader, Adobe Premiere LE and Adobe Photoshop Elements are trademarks of Adobe Systems Incorporated.

QuickTime and the QuickTime logo are trademarks used under licence. QuickTime is registered in the U.S. and other countries.

RealOne Player is a trademark or registered trademark of RealNetworks, Inc. in the U.S. and other countries.

MoodLogic is a trademark of MoodLogic, Inc.

PowerPanel is a trademark of Phoenix Technologies Ltd.

Norton Internet Security 2003 is a trademark of Symantec Corporation.

EverQuest is a registered trademark of Sony Computer Entertainment America Inc.

Click to DVD is a trademark of Sony Electronics.

Drag'n Drop CD+DVD is a registered trademark of Easy Systems Japan Ltd.

WinDVD for VAIO is a trademark of InterVideo, Inc.

WOW, SRS and the (O) symbol are trademarks of SRS Labs, Inc. WOW technology is incorporated under licence from SRS Labs, Inc.

PowerDVD for VAIO is a trademark or registered trademark of CyberLink Corporation.

All other names of systems, products and services are trademarks of their respective owners. In the manual, the ™ or ® marks are not specified.

Specifications are subject to change without notice. All other trademarks are trademarks of their respective owners.

Please see the printed Specifications sheet to see what software is available for your model.